

BSAP-1600
2.4 GHz / 5 GHz
Dual Band Outdoor
Access Point / Bridge
User Guide



Bluesocket, Inc.
10 North Avenue
Burlington, MA 01803 USA
+1 781-328-0888
www.bluesocket.com
Part Number: 870-01600-M00
Document Version 1.0

Copyright Notice

Copyright © 2003, 2004, 2005, 2006 Bluesocket, Inc. All rights reserved.

No part of this document may be reproduced in any form or by any means, electronic or manual, including photocopying without the written permission of Bluesocket, Inc.

The products described in this document may be protected by one or more U.S. patents, foreign patents, or pending patents.

This document is provided "as is" without warranty of any kind, either express or implied, including, but not limited to, the implied warranties of merchantability, fitness for a particular purpose, or non-infringement. This publication could include technical inaccuracies or typographical errors. Changes are periodically added to the information herein; these changes will be incorporated in new editions of the document. Bluesocket inc. may make improvements or changes in the products or the programs described in this document at any time.

Trademarks

Bluesocket, The Bluesocket Logo, Secure Mobility, BlueView, BlueSecure, DynamicRF, HighDataDensity and CellularLAN are trademarks or registered trademarks of Bluesocket, Inc.

Bluetooth is a trademark owned by Bluetooth SIG, Inc., U.S.A. and is licensed to Bluesocket, Inc.

All other trademarks, trade names and company names referenced herein are used for identification purposes only and are the property of their respective owners.

Publication Date: July 28, 2006



Contents

Tables

Compliances

Federal Communication Commission Interference Statement	iv-xiii
IMPORTANT NOTE: FCC Radiation Exposure Statement	xiii
Wireless 5 GHz Band Statement:	xiii
EC Conformance Declaration	xiv
Countries of Operation & Conditions of Use in the European Community .	xiv
Operation Using 5 GHz Channels in the European Community.....	xv
Safety Compliance: Power Cord Safety.....	xv

About This Guide

Audience	xx
Document Organization	xx
Notational Conventions	xxi
Related Documentation	xxi
Terminology	xxii

Chapter 1 Introduction

Radio Characteristics	1-1
Package Checklist	1-2
Hardware Description.....	1-2
LED Indicators	1-3
External Antenna Options.....	1-5
Ethernet Port	1-5
Power Injector Module	1-6
Grounding Point.....	1-6
Wall- and Pole-Mounting Bracket Kits.....	1-7
System Configuration.....	1-7
Features and Benefits.....	1-7

Chapter 2 Hardware Installation

Testing Basic Link Operation.....	2-1
Mount the BSAP-1600	2-1
Using the Pole-Mounting Bracket.....	2-2
Using the Wall-Mounting Bracket	2-3
Connect External Antennas.....	2-4
Connect Cables to the BSAP-1600	2-5
Connect the Power Injector	2-6
Align Antennas	2-7

Chapter 3 Network Configuration	
Access Point Topologies	3-1
Infrastructure Wireless LAN	3-1
Infrastructure Wireless LAN for Roaming Wireless PCs	3-2
Bridge Link Topologies	3-3
Point-to-Point Configuration	3-3
Point-to-Multipoint Configuration	3-4
Chapter 4 Bridge Link Planning	
Data Rates	4-1
Radio Path Planning	4-2
Antenna Height	4-3
Antenna Position and Orientation	4-4
Radio Interference	4-5
Weather Conditions	4-5
Ethernet Cabling	4-5
Grounding	4-6
Chapter 5 Initial Configuration	
Initial Setup through the Command Line Interface (CLI)	5-1
Required Connections	5-1
Initial Configuration Steps	5-2
Logging In	5-3
Chapter 6 System Configuration	
Advanced Configuration	6-1
System	6-3
Identification	6-3
TCP / IP Settings	6-4
RADIUS	6-6
SSH Settings	6-9
Authentication	6-10
Filter Control	6-14
VLAN	6-16
WDS Settings	6-18
AP Management	6-23
Administration	6-24
System Log	6-28
RSSI	6-32
SNMP	6-33
Configuring SNMP and Trap Message Parameters	6-34
Configuring SNMPv3 Users	6-38
Configuring SNMPv3 Trap Filters	6-39
Configuring SNMPv3 Targets	6-41
Radio Interface	6-43
Radio Settings A (802.11a)	6-44
Radio Settings G (802.11g)	6-57
Security	6-59
Status Information	6-75
Access Point Status	6-75
Station Status	6-77
Event Logs	6-79
STP Status	6-81

Chapter 7 Command Line Interface

Using the Command Line Interface	7-1
Accessing the CLI.....	7-1
Console Connection.....	7-1
Telnet Connection	7-1
Entering Commands	7-2
Keywords and Arguments	7-2
Minimum Abbreviation	7-2
Command Completion	7-3
Getting Help on Commands.....	7-3
Partial Keyword Lookup.....	7-3
Negating the Effect of Commands.....	7-4
Using Command History.....	7-4
Understanding Command Modes	7-4
Exec Commands.....	7-4
Configuration Commands	7-4
Command Line Processing	7-5
Command Groups.....	7-6
General Commands	7-7
configure	7-7
end.....	7-8
exit	7-8
ping.....	7-8
reset.....	7-9
show history.....	7-9
show line.....	7-10
System Management Commands.....	7-10
country	7-11
prompt	7-13
system name	7-13
username.....	7-14
password.....	7-14
ip ssh-server enable	7-14
ip ssh-server port	7-15
ip telnet-server enable	7-15
ip http port.....	7-16
ip http server	7-16
ip http session-timeout.....	7-16
ip https port	7-17
ip https server.....	7-17
web-redirect.....	7-18
APmgmtIP	7-18
APmgmtUI.....	7-19
show apmanagement.....	7-20
show system.....	7-20
show version	7-21
show config	7-22
show hardware	7-26
System Logging Commands	7-26
logging on.....	7-27
logging host.....	7-27
logging console.....	7-27
logging level	7-28
logging facility-type.....	7-28

logging clear	7-29
show logging	7-29
show event-log	7-29
System Clock Commands	7-30
ntp-server ip	7-30
ntp-server enable	7-31
ntp-server date-time	7-31
ntp-server daylight-saving	7-32
ntp-server timezone	7-32
show ntp	7-32
DHCP Relay Commands	7-33
dhcp-relay enable	7-33
dhcp-relay	7-34
show dhcp-relay	7-34
SNMP Commands	7-35
snmp-server community	7-35
snmp-server contact	7-36
snmp-server location	7-36
snmp-server enable server	7-37
snmp-server host	7-37
snmp-server trap	7-38
snmp-server engine-id	7-39
snmp-server user	7-40
snmp-server targets	7-41
snmp-server filter	7-42
snmp-server filter-assignments	7-43
show snmp groups	7-43
show snmp users	7-44
show snmp group-assignments	7-44
show snmp target	7-45
show snmp filter	7-45
show snmp filter-assignments	7-45
show snmp	7-46
Flash/File Commands	7-47
bootfile	7-47
copy	7-48
delete	7-49
dir	7-49
show bootfile	7-50
RADIUS Client	7-50
radius-server address	7-51
radius-server port	7-51
radius-server key	7-51
radius-server retransmit	7-52
radius-server timeout	7-52
radius-server port-accounting	7-52
radius-server timeout-interim	7-53
radius-server radius-mac-format	7-53
radius-server vlan-format	7-54
show radius	7-54
802.1X Authentication	7-55
802.1x	7-55
802.1x broadcast-key-refresh-rate	7-56
802.1x session-key-refresh-rate	7-56

802.1x session-timeout	7-57
802.1x-suppliant enable	7-57
802.1x-suppliant user	7-58
show authentication	7-58
MAC Address Authentication	7-59
address filter default	7-59
address filter entry	7-60
address filter delete	7-60
mac-authentication server	7-60
mac-authentication session-timeout	7-61
Filtering Commands	7-62
filter local-bridge	7-62
filter ap-manage	7-63
filter uplink enable	7-63
filter uplink	7-63
filter ethernet-type enable	7-63
filter ethernet-type protocol	7-64
show filters	7-64
WDS Bridge Commands	7-65
bridge mode	7-66
bridge role (WDS)	7-66
bridge channel-auto-sync	7-67
bridge-link parent	7-67
bridge-link child	7-67
bridge dynamic-entry age-time	7-68
show bridge aging-time	7-68
show bridge filter-entry	7-69
show bridge link	7-69
Spanning Tree Commands	7-71
bridge stp enable	7-71
bridge stp forwarding-delay	7-71
bridge stp hello-time	7-72
bridge stp max-age	7-72
bridge stp priority	7-73
bridge-link path-cost	7-73
bridge-link port-priority	7-74
show bridge stp	7-74
Ethernet Interface Commands	7-75
interface ethernet	7-75
dns server	7-76
ip address	7-76
ip dhcp	7-77
speed-duplex	7-77
shutdown	7-78
show interface ethernet	7-78
Wireless Interface Commands	7-79
interface wireless	7-80
vap	7-81
speed	7-81
turbo	7-82
multicast-data-rate	7-82
channel	7-83
transmit-power	7-83
radio-mode	7-84

preamble	7-84
antenna control	7-85
antenna id	7-85
antenna location	7-86
beacon-interval	7-86
dtim-period	7-87
fragmentation-length	7-87
rts-threshold	7-88
super-a	7-88
super-g	7-89
description	7-89
ssid	7-89
closed-system	7-90
max-association	7-90
assoc-timeout-interval	7-90
auth-timeout-value	7-91
shutdown	7-91
show interface wireless	7-91
show station	7-94
Rogue AP Detection Commands	7-95
rogue-ap enable	7-95
rogue-ap authenticate	7-96
rogue-ap duration	7-96
rogue-ap interval	7-97
rogue-ap scan	7-97
show rogue-ap	7-98
Wireless Security Commands	7-98
auth	7-99
encryption	7-100
key	7-101
transmit-key	7-102
cipher-suite	7-102
mic_mode	7-103
wpa-pre-shared-key	7-104
pmksa-lifetime	7-104
pre-authentication	7-105
Link Integrity Commands	7-106
link-integrity ping-detect	7-106
link-integrity ping-host	7-107
link-integrity ping-interval	7-107
link-integrity ping-fail-retry	7-107
link-integrity ethernet-detect	7-108
show link-integrity	7-108
IAPP Commands	7-109
iapp	7-109
VLAN Commands	7-110
vlan	7-110
management-vlanid	7-111
vlan-id	7-111
WMM Commands	7-112
wmm	7-112
wmm-acknowledge-policy	7-113
wmmparam	7-113

Appendix A Troubleshooting

Appendix B Cables and Pinouts

Twisted-Pair Cable Assignments	B-1
10/100BASE-TX Pin Assignments	B-1
Straight-Through Wiring	B-2
Crossover Wiring	B-2
8-Pin DIN Connector Pinout.....	B-3
8-Pin DIN to RJ-45 Cable Wiring	B-3

Appendix C Specifications

General Specifications	C-1
Sensitivity	C-3
Transmit Power	C-4
Operating Range.....	C-5

Index

Tables

Table 1:	Allowed 5GHz Channels in Each European Community Country	iv-xv
Table 2:	Power Cord Set	iv-xvi
Table 3:	Cordon électrique - Il doit être agrué dans le pays d'utilisation.	iv-xvii
Table 4:	Stromkabel. Dies muss von dem Land, in dem es benutzt wird geprüft werden.....	iv-xviii
Table 1-1:	System Status LEDs.....	1-3
Table 1-2:	Wireless Status LEDs in AP Mode.....	1-4
Table 1-3:	Wireless Status LEDs in RSSI Mode	1-4
Table 1-4:	External Antenna Options	1-5
Table 4-1:	Antenna Approximate maximum link distances	4-1
Table 4-2:	Antenna Minimum Clearance	4-3
Table 6-1:	Advanced Configuration Pages Menu Options	6-2
Table 6-2:	RADIUS Attributes and Values for VLAN ID Setup	6-17
Table 6-3:	System Logging Error Messages	6-29
Table 6-4:	WMM Access Categories	6-52
Table 6-5:	Wireless Security Considerations	6-60
Table 6-6:	Security Combinations.....	6-61
Table 6-7:	WPA Configuration Settings.....	6-72
Table 6-8:	Status page.....	6-75
Table 7-1:	Command Classes and Associated Modes.....	7-4
Table 7-2:	Keystroke Commands.....	7-5
Table 7-3:	Command Groups	7-6
Table 7-4:	General Commands.....	7-7
Table 7-5:	System Management Commands	7-10
Table 7-6:	Country Codes	7-12
Table 7-7:	System Logging Commands	7-26
Table 7-8:	Logging Level Message Descriptions	7-28
Table 7-9:	System Clock Commands.....	7-30
Table 7-10:	BHCP Relay Commands	7-33
Table 7-11:	SNMP Commands	7-35
Table 7-12:	Flash/File Commands	7-47
Table 7-13:	RADIUS Client	7-50
Table 7-14:	802.1X Authentication	7-55
Table 7-15:	MAC Address Authentication	7-59
Table 7-16:	Filtering Commands	7-62
Table 7-17:	WDS Bridge Commands	7-65
Table 7-18:	Spanning Tree Commands.....	7-71
Table 7-19:	Ethernet Interface Commands.....	7-75
Table 7-20:	Wireless Interface Commands	7-79
Table 7-21:	Rogue AP Detection Commands.....	7-95
Table 7-22:	Wireless Security Commands	7-98
Table 7-23:	Link Integrity Commands.....	7-106
Table 7-24:	VLAN Commands	7-110
Table 7-25:	WMM Commands	7-112
Table 7-26:	AP Parameters.....	7-114
Table 7-27:	BSS Parameters	7-114
Table B-1:	10/100BASE-TX MDI Port Pinouts.....	B-2
Table B-2:	8-Pin DIN Ethernet Port Pinout.....	B-3
Table C-1:	IEEE 802.11a Sensitivity (GHz - dBm)	C-3
Table C-2:	IEEE 802.11g	C-3
Table C-3:	IEEE 802.11b	C-4
Table C-4:	IEEE 802.11a Maximum Output Power (GHz - dBm).....	C-4

Table C-5:	IEEE 802.11g Maximum Output Power (GHz - dBm).....	C-4
Table C-6:	IEEE 802.11b Maximum Output Power (GHz - dBm).....	C-5
Table C-7:	802.11a Wireless Distance Table - Speed and Distance Ranges	C-5
Table C-8:	802.11g Wireless Distance Table - Speed and Distance Ranges	C-5
Table C-9:	802.11b Wireless Distance Table - Speed and Distance Ranges	C-5



Compliances

Federal Communication Commission Interference Statement

This equipment has been tested and found to comply with the limits for a Class B digital device, pursuant to Part 15 of the FCC Rules. These limits are designed to provide reasonable protection against harmful interference in a residential installation. This equipment generates, uses and can radiate radio frequency energy and, if not installed and used in accordance with the instructions, may cause harmful interference to radio communications. However, there is no guarantee that interference will not occur in a particular installation. If this equipment does cause harmful interference to radio or television reception, which can be determined by turning the equipment off and on, the user is encouraged to try to correct the interference by one of the following measures:

- Reorient or relocate the receiving antenna
- Increase the separation between the equipment and receiver
- Connect the equipment into an outlet on a circuit different from that to which the receiver is connected
- Consult the dealer or an experienced radio/TV technician for help

FCC Caution: Any changes or modifications not expressly approved by the party responsible for compliance could void the user's authority to operate this equipment. This device complies with Part 15 of the FCC Rules. Operation is subject to the following two conditions: (1) This device may not cause harmful interference, and (2) this device must accept any interference received, including interference that may cause undesired operation.

IMPORTANT NOTE: FCC Radiation Exposure Statement

This equipment complies with FCC radiation exposure limits set forth for an uncontrolled environment. This equipment should be installed and operated with a minimum distance of 20 centimeters (8 inches) between the radiator and your body. This transmitter must not be co-located or operating in conjunction with any other antenna or transmitter.

Wireless 5 GHz Band Statement:

As the BSAP-1600 can operate in the 5150-5250 MHz frequency band it is limited by the FCC, Industry Canada and some other countries to

indoor use only so as to reduce the potential for harmful interference to co-channel Mobile Satellite systems.

High power radars are allocated as primary users (meaning they have priority) of the 5250-5350 MHz and 5650-5850 MHz bands. These radars could cause interference and/or damage to the BSAP-1600.

EC Conformance Declaration

Marking by the above symbol indicates compliance with the Essential Requirements of the R&TTE Directive of the European Union (1999/5/EC). This equipment meets the following conformance standards:

- EN 60950 (IEC 60950) - Product Safety
- EN 301 893 - Technical requirements for 5 GHz radio equipment
- EN 300 328 - Technical requirements for 2.4 GHz radio equipment
- EN 301 489-1 / EN 301 489-17 - EMC requirements for radio equipment

Countries of Operation & Conditions of Use in the European Community

This device is intended to be operated in all countries of the European Community. Requirements for indoor vs. outdoor operation, license requirements and allowed channels of operation apply in some countries as described below:

Note: The user must use the configuration utility provided with this product to ensure the channels of operation are in conformance with the spectrum usage rules for European Community countries as described below.

- This device requires that the user or installer properly enter the current country of operation in the command line interface as described in the user guide, before operating this device.
- This device will automatically limit the allowable channels determined by the current country of operation. Incorrectly entering the country of operation may result in illegal operation and may cause harmful interference to other system. The user is obligated to ensure the device is operating according to the channel limitations, indoor/outdoor restrictions and license requirements for each European Community country as described in this document.
- This device employs a radar detection feature required for European Community operation in the 5 GHz band. This feature is automatically enabled when the country of operation is correctly configured for any European Community country. The presence of nearby radar operation may result in temporary interruption of operation of this device. The radar detection feature will automatically restart operation on a channel free of radar.
- The 5 GHz Turbo Mode feature is not allowed for operation in any European Community country. The current setting for this feature is found in the 5 GHz 802.11a Radio Settings Window as described in the user guide.
- The 5 GHz radio's Auto Channel Select setting described in the user guide must always remain enabled to ensure that automatic 5 GHz channel

selection complies with European requirements. The current setting for this feature is found in the 5 GHz 802.11a Radio Settings Window as described in the user guide.

- This device may be operated *indoors or outdoors* in all countries of the European Community using the 2.4 GHz band: Channels 1 - 13, except where noted below.
 - In Italy the end-user must apply for a license from the national spectrum authority to operate this device outdoors.
 - In Belgium outdoor operation is only permitted using the 2.46 - 2.4835 GHz band: Channel 13.
 - In France outdoor operation is only permitted using the 2.4 - 2.454 GHz band: Channels 1 - 7

Operation Using 5 GHz Channels in the European Community

The user/installer must use the provided configuration utility to check the current channel of operation and make necessary configuration changes to ensure operation occurs in conformance with European National spectrum usage laws as described below and elsewhere in this document.

Table 1: Allowed 5GHz Channels in Each European Community Country

Allowed Frequency Bands	Allowed Channel Numbers	Countries
5.15 - 5.25 GHz*	36, 40, 44, 48	Austria, Belgium
5.15 - 5.35 GHz*	36, 40, 44, 48, 52, 56, 60, 64	France, Switzerland, Liechtenstein
5.15 - 5.35* & 5.470 - 5.725 GHz	36, 40, 44, 48, 52, 56, 60, 64, 100, 104, 108, 112, 116, 120, 124, 128, 132, 136, 140	Denmark, Finland, Germany, Iceland, Ireland, Italy, Luxembourg, Netherlands, Norway, Portugal, Spain, Sweden, U.K.
5 GHz Operation Not Allowed	None	Greece

* Outdoor operation is not allowed using 5.15-5.35 GHz bands (Channels 36 - 64). Channels 36 - 64 are currently not available for use.

Safety Compliance: Power Cord Safety

Please read the following safety information carefully before installing the device:

Caution: Installation and removal of the BSAP-1600 must be carried out by qualified personnel only.

- The BSAP-1600 must be connected to an earthed (grounded) outlet to comply with international safety standards.
- Do not connect the BSAP-1600 to an A.C. outlet (power supply) without an earth (ground) connection.
- The appliance coupler (the connector to the BSAP-1600 and not the wall plug) must have a configuration for mating with an EN 60320/IEC 320 appliance inlet.

- The socket outlet must be near to the BSAP-1600 and easily accessible. You can only remove power from the BSAP-1600 by disconnecting the power cord from the outlet.
- This BSAP-1600 operates under SELV (Safety Extra Low Voltage) conditions according to IEC 60950. The conditions are only maintained if the equipment to which it is connected also operates under SELV conditions.

France and Peru only

This BSAP-1600 cannot be powered from IT[†] supplies. If your supplies are of IT type, this BSAP-1600 must be powered by 230 V (2P+T) via an isolation transformer ratio 1:1, with the secondary connection point labelled Neutral, connected directly to earth (ground).

† Impédance à la terre

Important! Before making connections, make sure you have the correct cord set. Check it (read the label on the cable) against the following:

Table 2: Power Cord Set

U.S.A and Canada	The cord set must be UL-approved and CSA certified. The minimum specifications for the flexible cord are: - No. 18 AWG - not longer than 2 meters, or 16 AWG. - Type SV or SJ - 3-conductor. The cord set must have a rated current capacity of at least 10 A. The attachment plug must be an earth-grounding type with NEMA 5-15P (15 A, 125 V) or NEMA 6-15P (15 A, 250 V) configuration.
Denmark	The supply plug must comply with Section 107-2-D1, Standard DK2-1a or DK2-5a.
Switzerland	The supply plug must comply with SEV/ASE 1011.
U.K.	The supply plug must comply with BS1363 (3-pin 13 A) and be fitted with a 5 A fuse which complies with BS1362. The mains cord must be <HAR> or <BASEC> marked and be of type HO3VVF3GO.75 (minimum).
Europe	The supply plug must comply with CEE7/7 ("SCHUKO"). The mains cord must be <HAR> or <BASEC> marked and be of type HO3VVF3GO.75 (minimum). IEC-320 receptacle.

Veillez lire à fond l'information de la sécurité suivante avant d'installer l'appareil:

AVERTISSEMENT: L'installation et la dépose de ce groupe doivent être confiés à un personnel qualifié.

- Ne branchez pas votre appareil sur une prise secteur (alimentation électrique) lorsqu'il n'y a pas de connexion de mise à la terre (mise à la masse).
- Vous devez raccorder ce groupe à une sortie mise à la terre (mise à la masse) afin de respecter les normes internationales de sécurité.
- Le coupleur d'appareil (le connecteur du groupe et non pas la prise murale) doit respecter une configuration qui permet un branchement sur une entrée d'appareil EN 60320/IEC 320.
- La prise secteur doit se trouver à proximité de l'appareil et son acc_s doit _tre facile. Vous ne pouvez mettre l'appareil hors circuit qu'en débranchant son cordon électrique au niveau de cette prise.
- L'appareil fonctionne à une tension extr_mement basse de sécurité qui est conforme à la norme IEC 60950. Ces conditions ne sont maintenues que si l'équipement auquel il est raccordé fonctionne dans les m_mes conditions.

France et Pérou uniquement:

Ce groupe ne peut pas _tre alimenté par un dispositif à impédance à la terre. Si vos alimentations sont du type impédance à la terre, ce groupe doit _tre alimenté par une tension de 230 V (2 P+T) par le biais d'un transformateur d'isolement à rapport 1:1, avec un point secondaire de connexion portant l'appellation Neutre et avec raccordement direct à la terre (masse).

Table 3:Cordon électrique - Il doit _tre agrué dans le pays d'utilisation.

Etats-Unis et Canada:	<ol style="list-style-type: none"> 1. Le cordon doit avoir reçu l'homologation des UL et un certificat de la CSA. 2. Les spécifications minimales pour un câble flexible sont AWG <ul style="list-style-type: none"> - No. 18, ou AWG No. 16 pour un câble de longueur inférieure à 2 m_tres. - type SV ou SJ - 3 conducteurs. 3. Le cordon doit _tre en mesure d'acheminer un courant nominal d'au moins 10 A. 4. La prise femelle de branchement doit _tre du type à mise à la terre (mise à la masse) et respecter la configuration NEMA 5-15P (15 A, 125 V) ou NEMA 6-15P (15 A, 250 V).
Danemark	La prise mâle d'alimentation doit respecter la section 107-2 D1 de la norme DK2 1a ou DK2 5a.
Suisse	La prise mâle d'alimentation doit respecter la norme SEV/ASE 1011.
Europe	<ol style="list-style-type: none"> 1. La prise secteur doit _tre conforme aux normes CEE 7/7 ("SCHUKO"). 2. LE cordon secteur doit porter la mention <HAR> ou <BASEC> et doit _tre de type HO3VVF3GO.75 (minimum).

Bitte unbedingt vor dem Einbauen des Geräts die folgenden Sicherheitsanweisungen durchlesen (Germany):

WARNUNG: Die Installation und der Ausbau des Geräts darf nur durch Fachpersonal erfolgen.

- Das Gerät sollte nicht an eine ungeerdete Wechselstromsteckdose angeschlossen werden.
- Das Gerät muß an eine geerdete Steckdose angeschlossen werden, welche die internationalen Sicherheitsnormen erfüllt.
- Der Gerätestecker (der Anschluß an das Gerät, nicht der Wandsteckdosenstecker) muß einen gemäß EN 60320/IEC 320 konfigurierten Geräteeingang haben.
- Die Netzsteckdose muß in der Nähe des Geräts und leicht zugänglich sein. Die Stromversorgung des Geräts kann nur durch Herausziehen des Gerätenetzkabels aus der Netzsteckdose unterbrochen werden.
- Der Betrieb dieses Geräts erfolgt unter den SELV-Bedingungen (Sicherheitskleinstspannung) gemäß IEC 60950. Diese Bedingungen sind nur gegeben, wenn auch die an das Gerät angeschlossenen Geräte unter SELV-Bedingungen betrieben werden.

Table 4:Stromkabel. Dies muss von dem Land, in dem es benutzt wird geprüft werden.

U.S.A und Canada	<ol style="list-style-type: none"> 1. Der Cord muß das UL geprüft und war das CSA beglaubigt. 2. Das Minimum spezifikation für der Cord sind: <ul style="list-style-type: none"> - Nu. 18 AWG - nicht mehr als 2 meter, oder 16 AWG. - Der typ SV oder SJ - 3-Leiter. 3. Der Cord muß haben eine strombelastbarkeit aus wenigstens 10 A. 4. Dieser Stromstecker muß hat einer erdschluss mit der typ NEMA 5-15P (15A, 125V) oder NEMA 6-15P (15A, 250V) konfiguration.
Danemark	Dieser Stromstecker muß die ebene 107-2-D1, der standard DK2-1a oder DK2-5a Bestimmungen einhalten.
Schweiz	Dieser Stromstecker muß die SEV/ASE 1011 Bestimmungen einhalten.
Europe	<ol style="list-style-type: none"> 1. Das Netzkabel muß vom Typ HO3VVF3GO.75 (Mindestanforderung) sein und die Aufschrift <HAR> oder <BASEC> tragen. 2. Der Netzstecker muß die Norm CEE 7/7 erfüllen ("SCHUKO").



About This Guide

The *BSAP-1600 User Guide* provides complete instructions for installing, powering up, configuring, and managing the BSAP-1600. This section introduces the document and describes:

- Audience
- Document Organization
- Notational Conventions
- Related Documentation
- Terminology

Audience

The *BBSAP-1600 User Guide* is written for network administrators who will physically install and power up the BSAP-1600.

We assume our audience is knowledgeable of and has experience administering switches, routers, or similar computer hardware.

Document Organization

The information in this guide is organized as follows:

- *Chapter 1, Introduction*, describes radio characteristics, package checklist, hardware description, led indicators, external antenna options, ethernet port, power injector module, grounding point, wall- and pole-mounting bracket kits, system configuration, and features and benefits.
- *Chapter 2, Hardware Installation*, provides complete procedures for installation, testing basic link operation, mounting the BSAP-1600, using the pole-mounting bracket, using the wall-mounting bracket, connecting external antennas, connecting cables to the BSAP-1600, connecting the power injector, and aligning antennas.
- *Chapter 3, Network Configuration*, describes the role of the BSAP-1600 in various wireless network configurations, covering: access point topologies, infrastructure wireless LAN, infrastructure wireless LAN for roaming wireless pcs, bridge link topologies, point-to-point configuration, and point-to-multipoint configuration.
- *Chapter 4, Bridge Link Planning*, provides guidance and information for planning your BSAP-1600 links, discussing: data rates, radio path planning, antenna height, antenna position and orientation, radio interference, weather conditions, and ethernet cabling, grounding.
- *Chapter 5, Initial Configuration*, describes the initial configuration steps performed through the web browser interface and the CLI to set up an IP address for the BSAP-1600, discussing: initial setup through the CLI, required connections, initial configuration steps, and logging in.
- *Chapter 6, System Configuration*, explain how to use the Advanced Configuration pages, specifically: RSSI, SNMP, Radio Interface, Status Information (Access Point, Station, Event Logs, and STP Status), and System (Identification, TCP / IP Settings, RADIUS, SSH Settings, Authentication, Filter Control, VLAN, WDS Settings, AP Management, Administration, and System Log).
- *Chapter 7, Command Line Interface*, explains how to access the management interface for the BSAP-1600 over a direct connection to the console port, or via a Telnet connection.
- *Appendix A, Troubleshooting*, explains several helpful troubleshooting procedures.
- *Appendix B, Cables and Pinouts*, describes twisted-pair cable assignments, 10/100BASE-TX pin assignments, straight-through wiring, crossover wiring, 8-pin DIN connector pinout, and 8-pin DIN to RJ-45 cable wiring.

- *Appendix C, Specifications*, describes general specifications, sensitivity, transmit power, and operating range

Notational Conventions

This guide uses the following notational conventions to convey information:

 **Note:** Notes call attention to important information.

 **Caution:** Cautionary statements call attention to a condition that could result in the loss of data, damage to equipment, or physical injury.

Italic text indicates emphasis or highlights the titles of books used in cross-references.

`Monospace` text represents information displayed on the local BlueSecure Controller command console or on other computer displays.

bold monospace text represents information that you enter at the BlueSecure Controller command console or at other computer terminals.

Related Documentation

Please refer to these other related documents for information about your BlueSecure Controller:

- *BlueSecure Controller Quick Start Guide* - Refer to this document included with your BSC distribution for a concise overview of how to get up and running quickly with your BSC.
- *BlueSecure Controller Setup and Administration Guide* - Refer to this document included with your BSC distribution for complete instructions for installing, powering up and configuring the Bluesocket BlueSecure Controller.
- *BlueView™ Management System User Guide* - Refer to this document for procedures to manage the BlueSecure Controllers installed on your network from a remote central location using the Bluesocket BlueView Management System.
- *BlueSecure Access Point 1500 Installation Guide* - Refer to this document included with your BSAP distribution for a concise overview of how to get up and running quickly with the Bluesocket BlueSecure 1500 Access Point.
- *BlueSecure Access Point 1540 Installation Guide* - Refer to this document included with your BSAP distribution for a concise overview of how to get up and running quickly with the Bluesocket BlueSecure 1540 Access Point.
- *BlueSecure Intrusion Protection System Centralized Sensor Installation Guide* - Refer to this document included with your BIPS Centralized Sensor distribution for instructions on physically installing the sensor, connecting it to your network, and configuring it with an IP address.

Terminology

For brevity, we use the term BSC to refer to the BlueSecure Controller product family as a whole, unless reference to a specific model is required.

We use the term BSAP to refer to the BlueSecure Access Point product family as a whole, unless reference to a specific model is required.

A *Glossary* is included in this document that defines many terms and acronyms associated with the BlueSecure Controller, the BlueSecure Access Point, and wireless networks.



Introduction

The BSAP-1600 provides point-to-point or point-to-multipoint bridge links between remote Ethernet LANs, and wireless access point services for clients in the local LAN area. The BSAP-1600 provides only external antenna options and is designed to operate as the “root bridge” in point-to-multipoint configurations, supporting wireless bridge connections to as many as six BSAP-1600s.

The BSAP-1600 is housed in a weatherproof enclosure for mounting outdoors and includes its own brackets for attaching to a wall, pole, radio mast, or tower structure. The BSAP-1600 is powered through its Ethernet cable connection from a power injector module that is installed indoors.

The wireless bridge system offers a fast, reliable, and cost-effective solution for connectivity between remote Ethernet wired LANs or to provide Internet access to an isolated site. The system is also easy to install and operate, ideal for situations where a wired link may be difficult or expensive to deploy. The BSAP-1600 connection provides data rates of up to 108 Mbps.

In addition, the BSAP-1600 offers full network management capabilities through an easy-to-use web interface, a command-line interface, and support for Simple Network Management Protocol (SNMP) tools.

Radio Characteristics

The IEEE 802.11a and 802.11g standards use a radio modulation technique known as Orthogonal Frequency Division Multiplexing (OFDM), and a shared collision domain (CSMA/CA). The 802.11a standard operates in the 5 GHz Unlicensed National Information Infrastructure (UNII) band, and the 802.11g standard in the 2.4 GHz band.

IEEE 802.11g includes backward compatibility with the IEEE 802.11b standard. IEEE 802.11b also operates at 2.4 GHz, but uses Direct Sequence Spread Spectrum (DSSS) and Complementary Code Keying (CCK) modulation technology to achieve a communication rate of up to 11 Mbps.

The BSAP-1600 provides a 54 Mbps half-duplex connection for each active channel (up to 108 Mbps in turbo mode on the 802.11a interface).

Package Checklist

The BSAP-1600 package includes:

- One Wireless Dual-band BSAP-1600
- One Category 5e network PoE cable, length 98 ft (30 m)
- One power injector module and power cord 5.9 ft (1.8 m)
- One RS232 console cable 5.9ft (1.8 m)
- Outdoor pole-mounting bracket kit
- Outdoor wall-mounting bracket kit
- User Guide CD

Inform your dealer if there are any incorrect, missing or damaged parts. If possible, retain the carton, including the original packing materials. Use them again to repack the product in case there is a need to return it.

Hardware Description

BSAP-1600
Bottom View

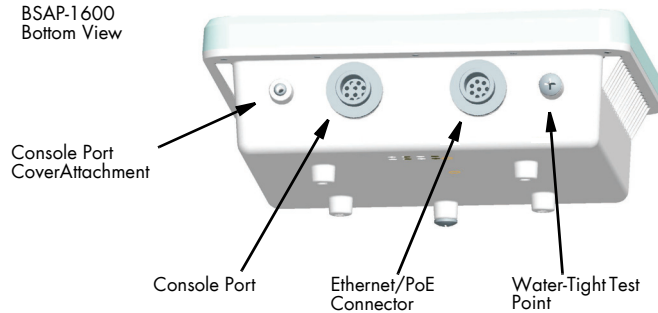

BSAP-1600
Top View

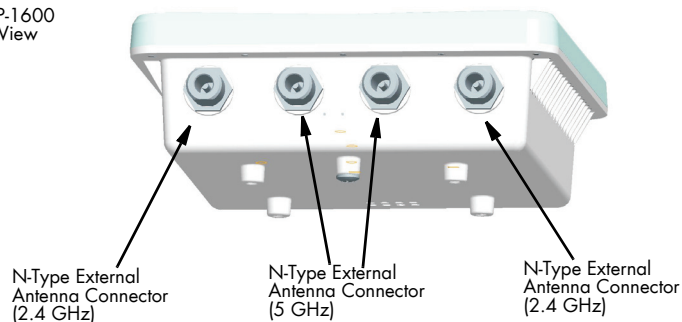

LED Indicators

The BSAP-1600 includes eight status LED indicators, as indicated in the following figure:

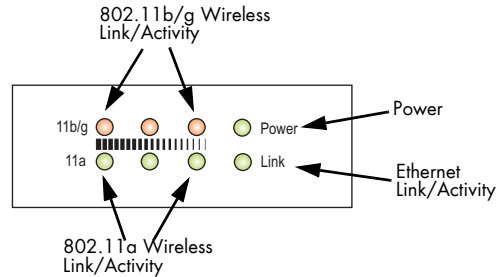

The following table describes the system status LEDs.

Table 1-1: System Status LEDs

LED	Status	Description
Power	On Green	Indicates that the system is working normally.
	On Amber	Indicates a power shutdown due to a low temperature condition.
Link	On Green.	Indicates a valid 10/100 Mbps Ethernet cable link
	Flashing Green	Indicates that the BSAP-1600 is transmitting or receiving data on a 10/100 Mbps Ethernet LAN. Flashing rate is proportional to network activity.

The 11a and 11b/g LEDs operate in two display modes, which are configurable through the management interface. The RSSI mode is for aligning antennas in a bridge link. The AP mode is for indicating data traffic rates.

The following table describes the wireless status LEDs in AP mode.

Table 1-2: Wireless Status LEDs in AP Mode

LED	Status	Description
11a (three LEDs)	Off	No signal detected or the 802.11a radio is disabled.
	Slow Flashing Green	The 802.11a radio is enabled with a low level of network activity.
	Fast Flashing Green	Indicates a medium level of network activity.
	On Green	Indicates a high level of network activity.
11b/g (three LEDs)	Off	No signal detected or the 802.11b/g radio is disabled.
	Slow Flashing Green	The 802.11b/g radio is enabled with a low level of network activity.
	Fast Flashing Green	Indicates a medium level of network activity.
	On Green	Indicates a high level of network activity.

The following table describes the wireless status LEDs in RSSI mode.

Table 1-3: Wireless Status LEDs in RSSI Mode

LED	Status	Description
11a (three LEDs)	Off	No signal detected or the 802.11a radio is disabled.
	Slow Flashing Green	The 802.11a radio is enabled with a low level signal.
	Fast Flashing Green	Indicates a medium level signal.
	On Green	Indicates a high level signal.
11b/g (three LEDs)	Off	No signal detected or the 802.11b/g radio is disabled.
	Slow Flashing Green	The 802.11b/g radio is enabled with a low level signal.
	Fast Flashing Green	Indicates a medium level signal.
	On Green	Indicates a high level signal.

External Antenna Options

The BSAP-1600 does not include an integrated antenna, but provides various external antenna options for both 5 GHz and 2.4 GHz operation. In a point-to-multipoint configuration, an external high-gain omnidirectional, sector, or high-gain panel antenna can be attached to communicate with BSAP-1600s spread over a wide area. The BSAP-1600 requires an omnidirectional or sector external antenna for 2.4 GHz operation. The following table summarizes antenna options:

Table 1-4: External Antenna Options

Antenna Type	Gain (dBi)	HPBW* Horizontal	HPBW* Vertical	Polarization	Model
2.46 GHz OMNI (2.46 GHz ~ 2.5 GHz)	8	360	15	Linear, vertical	ANT-005
5.0 GHz OMNI (5.47 GHz ~ 5.875 GHz)	8	360	12	Linear, vertical	ANT-006
2.4 GHz High Gain Panel (2.4 GHz ~ 2.5 GHz)	14.5	31	29	Linear, vertical	ANT-007
5.0 GHz High Gain Panel (5.150 GHz ~ 5.875 GHz)	13	31	27	Linear, vertical	ANT-008

* Half-power beam width in degrees

External antennas connect to the N-type RF connectors on the BSAP-1600 using the provided coaxial cables.

Ethernet Port

The BSAP-1600 has one 10BASE-T/100BASE-TX 8-pin DIN port that connects to the power injector module using the included Ethernet cable. The Ethernet port connection provides power to the BSAP-1600 as well as a data link to the local network.

The BSAP-1600 appears as an Ethernet node and performs a bridging function by moving packets from the wired LAN to the remote end of the wireless bridge link.

Note: The BSAP-1600 power injector module does not support Power over Ethernet (PoE) based on the IEEE 802.3af standard. The BSAP-1600 must always be powered on by being connected to the BSAP-1600 power injector module.

Power Injector Module

The BSAP-1600 receives power through its network cable connection using power-over-Ethernet technology. A power injector module is included in the BSAP-1600 package and provides two RJ-45 Ethernet ports, one for connecting to the BSAP-1600 (Output), and the other for connecting to a local LAN switch (Input).

The Input port uses an MDI (i.e., internal straight-through) pin configuration. You can therefore use straight-through twisted-pair cable to connect this port to most network interconnection devices such as a switch or router that provide MDI-X ports. However, when connecting the BSAP-1600 to a workstation or other device that does not have MDI-X ports, you must use crossover twisted-pair cable.

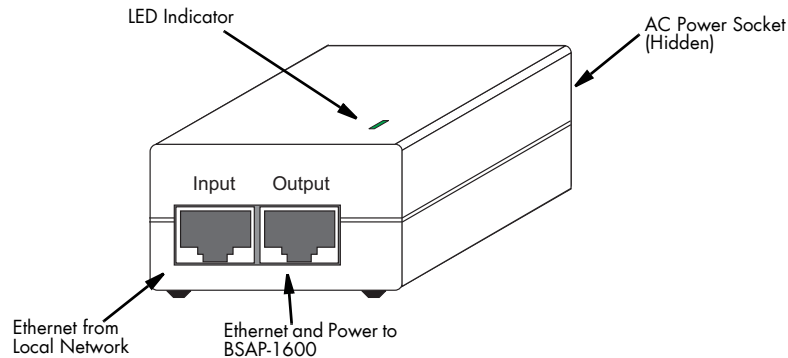

The BSAP-1600 does not have a power switch. It is powered on when its Ethernet port is connected to the power injector module, and the power injector module is connected to an AC power source. The power injector includes one LED indicator that turns on when AC power is applied.

The power injector module automatically adjusts to any AC voltage between 100-240 volts at 50 or 60 Hz. No voltage range settings are required.

⚠ Caution: The power injector module is designed for indoor use only. Never mount the power injector outside with the BSAP-1600.

Grounding Point

Even though the BSAP-1600 includes its own built-in lightning protection, it is important that the BSAP-1600 is properly connected to ground. A grounding screw is provided for attaching a ground wire to the BSAP-1600.

Wall- and Pole-Mounting Bracket Kits

The BSAP-1600 includes bracket kits that can be used to mount the BSAP-1600 to a wall, pole, radio mast, or part of a tower structure.

System Configuration

At each location where a BSAP-1600 is installed, it must be connected to the local network using the power injector module. The following figure illustrates the system component connections.

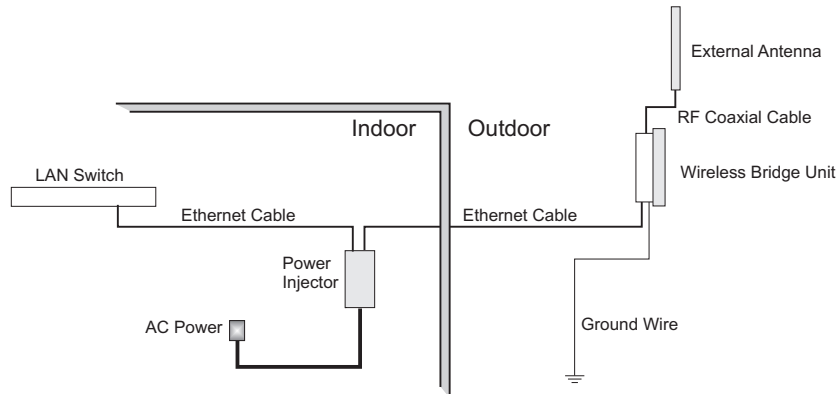

Features and Benefits

- The BSAP-1600 supports 5 GHz point-to-multipoint links using various external antenna options
- The BSAP-1600 also supports access point services for the 5 GHz and 2.4 GHz radios using various external antenna options
- Maximum data rate up to 108 Mbps on the 802.11a (5 GHz) radio
- Outdoor weatherproof design
- IEEE 802.11a and 802.11b/g compliant
- Local network connection via 10/100 Mbps Ethernet port
- Powered through its Ethernet cable connection to the power injector module
- Includes wall- and pole-mount brackets
- Security through 64/128/152-bit Wired Equivalent Protection (WEP) or 128-bit Advanced Encryption Standard (AES) encryption
- Scans all available channels and selects the best channel and data rate based on the signal-to-noise ratio
- Manageable through an easy-to-use web-browser interface, command line (via Telnet), or SNMP network management tools

2)))

Hardware Installation

Before mounting antennas to set up your BSAP-1600 links, be sure you have selected appropriate locations for each antenna. Follow the guidance and information in Chapter 2, “Wireless Link Planning.”

Also, before mounting BSAP-1600s in their intended locations, you should first perform initial configuration and test the basic operation of the BSAP-1600 links in a controlled environment over a very short range. (See the section Testing Basic Link Operation in this chapter.)

The BSAP-1600 includes its own bracket kit for mounting the BSAP-1600 to a 1.5 to 2 inch diameter steel pole or tube. The pole-mounting bracket allows the BSAP-1600 to be mounted to part of a radio mast or tower structure. The BSAP-1600 also has a wall-mounting bracket kit that enables it to be fixed to a building wall or roof when using external antennas.

Hardware installation of the BSAP-1600 involves these steps:

1. Mount the BSAP-1600 on a wall, pole, mast, or tower using the mounting bracket.
2. Mount external antennas on the same supporting structure as the BSAP-1600 and connect them to the BSAP-1600.
3. Connect the Ethernet cable and a grounding wire to the BSAP-1600.
4. Connect the power injector to the Ethernet cable, a local LAN switch, and an AC power source.
5. Align antennas at both ends of the link.

Testing Basic Link Operation

Set up the BSAP-1600s over a very short range (15 to 25 feet), either outdoors or indoors. Connect the BSAP-1600s as indicated in this chapter and be sure to perform all the basic configuration tasks outlined in Chapter 4, “Initial Configuration.” When you are satisfied that the links are operating correctly, proceed to mount the BSAP-1600s in their intended locations.

Mount the BSAP-1600

The BSAP-1600 can be mounted on the following types of surfaces:

- 1.5 to 2 inch diameter Pole

- Wall

Using the Pole-Mounting Bracket

Perform the following steps to mount the BSAP-1600 to a 1.5 to 2 inch diameter steel pole or tube using the mounting bracket:

1. Always attach the bracket to a pole with the open end of the mounting grooves facing up.
2. Place the V-shaped part of the bracket around the pole and tighten the securing nuts just enough to hold the bracket to the pole. (The bracket may need to be rotated around the pole during the alignment process.)

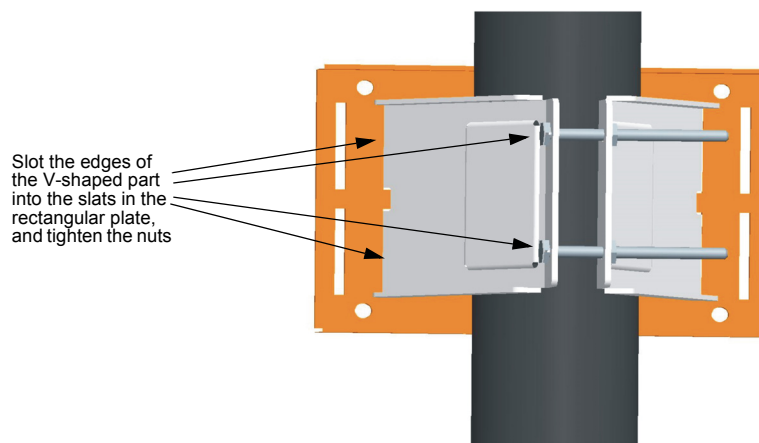
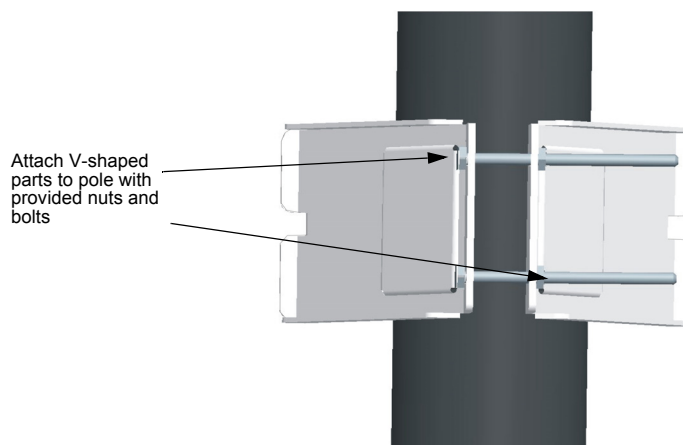

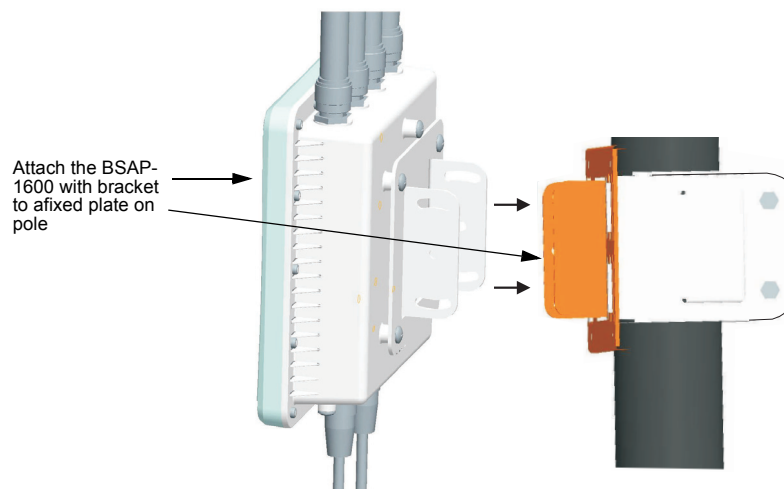
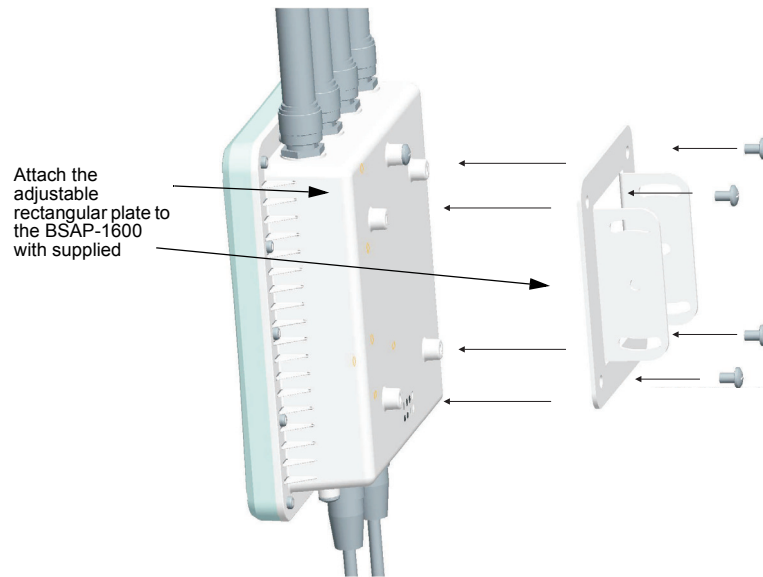

Use the included nuts to tightly secure the BSAP-1600 to the bracket. Be sure to take account of the antenna polarization direction; all antennas in a link must be mounted with the same polarization.

Using the Wall-Mounting Bracket

Perform the following steps to mount the BSAP-1600 to a wall using the wall-mounting bracket:

Note: The wall-mounting bracket does not allow the BSAP-1600's integrated antenna to be aligned. It is intended for use with the BSAP-1600 using external antennas.

1. Always attach the bracket to a wall with flat side flush against the wall (see following figure).

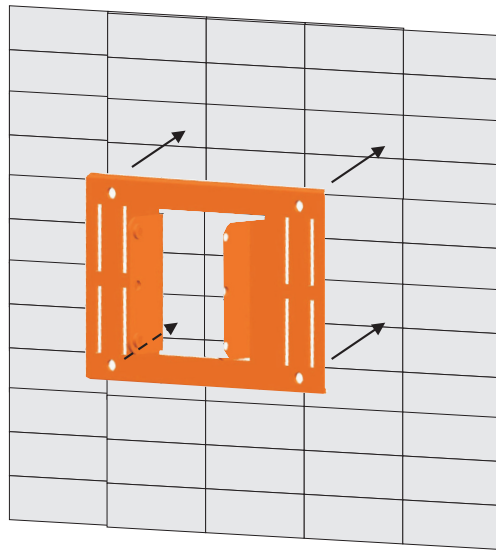

2. Position the bracket in the intended location and mark the position of the three mounting screw holes.
3. Drill three holes in the wall that match the screws and wall plugs included in the bracket kit, then secure the bracket to the wall.
4. Use the included nuts to tightly secure the BSAP-1600 to the bracket.

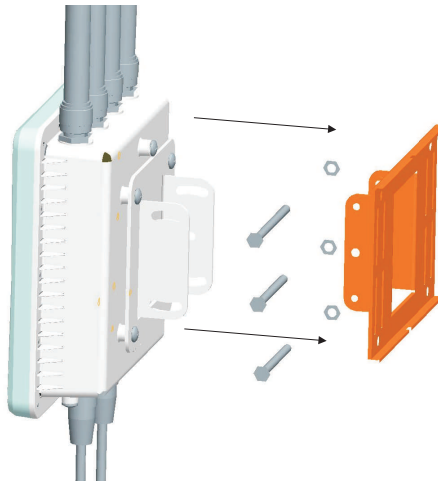

Connect External Antennas

When deploying a BSAP-1600 for a bridge link or access point operation, you need to mount external antennas and connect them to the BSAP-1600. Typically, a bridge link requires a 5 GHz antenna, and access point operation requires a 2.4 GHz antenna, but either radio can be configured for bridging or access point operation.

Perform these steps:

1. Mount the external antenna to the same supporting structure as the BSAP-1600, within 3 m (10 ft) distance, using the bracket supplied in the antenna package.
2. Connect the antenna to the BSAP-1600's N-type connector using the RF coaxial cable provided in the antenna package. Some omnidirectional external antennas attach directly to an N-type connector without using a coaxial cable.
3. Apply weatherproofing tape to the antenna connectors to help prevent water entering the connectors.

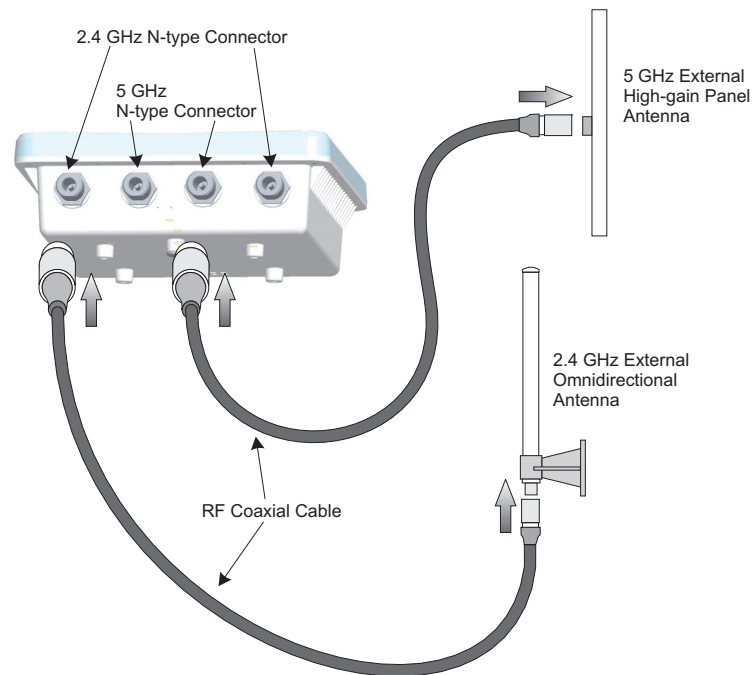

Connect Cables to the BSAP-1600

Caution: Do not connect or disconnect cables or otherwise work with the BSAP-1600 during periods of lightning activity.

1. Attach the Ethernet cable to the Ethernet port on the BSAP-1600.
2. For extra protection against rain or moisture, apply weatherproofing tape (not included) around the Ethernet connector.
3. Be sure to ground the BSAP-1600 with an appropriate grounding wire (not included) by attaching it to the grounding screw on the BSAP-1600.

Caution: Be sure that grounding is available and that it meets local and national electrical codes. For additional lightning protection, use lightning rods, lightning arrestors, or surge suppressors.

Note: The Ethernet cable included with the package is 30 m (100 ft) long. If a longer cable is required (maximum 100 m, 325 ft), one can be constructed using the connector pinout information in Appendix B.

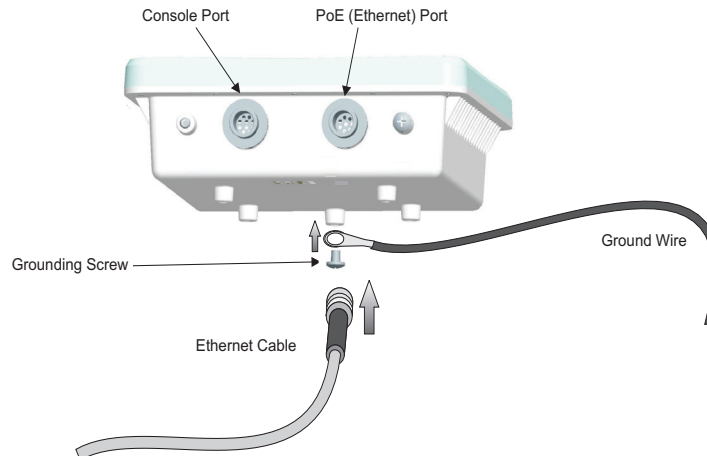

Connect the Power Injector

To connect the BSAP-1600 to a power source:

Caution: Do not install the power injector outdoors. The BSAP-1600 is for indoor installation only.

Note: The BSAP-1600's Ethernet port does not support Power over Ethernet (PoE) based on the IEEE 802.3af standard. Do not attempt to power the BSAP-1600 by connecting it directly to a network switch that provides IEEE 802.3af PoE. Always connect the BSAP-1600 to the included power injector module.

1. Connect the Ethernet cable from the BSAP-1600 to the RJ-45 port labeled "Output" on the power injector.
2. Connect a straight-through unshielded twisted-pair (UTP) cable from a local LAN switch to the RJ-45 port labeled "Input" on the power injector. Use Category 5e or better UTP cable for 10/100BASE-TX connections.

Note: The RJ-45 port on the power injector is an MDI port. If connecting directly to a computer for testing the link, use a crossover cable.

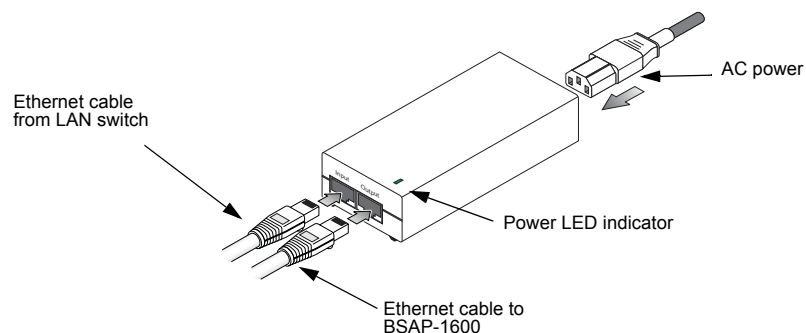

1. Insert the power cable plug directly into the standard AC receptacle on the power injector.

2. Plug the other end of the power cable into a grounded, 3-pin socket, AC power source.

Note: For International use, you may need to change the AC line cord. You must use a line cord set that has been approved for the receptacle type in your country.

3. Check the LED on top of the power injector to be sure that power is being supplied to the BSAP-1600 through the Ethernet connection.

Align Antennas

After the BSAP-1600s have been mounted, connected, and their radios are operating, the antennas must be accurately aligned to ensure optimum performance on the bridge links. This alignment process is particularly important for long-range point-to-point links. In a point-to-multipoint configuration the root bridge uses an omnidirectional or sector antenna, which does not require alignment, but bridge nodes still need to be correctly aligned with the root bridge antenna.

- **Point-to-Point Configurations** – In a point-to-point configuration, the alignment process requires two people at each end of the link. The use of cell phones or two-way radio communication may help with coordination. To start, you can just point the antennas at each other, using binoculars or a compass to set the general direction. For accurate alignment, you must monitor the signal strength LEDs as the antenna moves horizontally and vertically.
- **Point-to-Multipoint Configurations** – In a point-to-multipoint configuration all bridge nodes must be aligned with the root bridge antenna. The alignment process is the same as in point-to-point links, but only the bridge node end of the link requires the alignment.

The signal strength LEDs indicate the received radio signal strength for a particular bridge link. The more LEDs that turn on, the stronger the signal. Alternatively, you can monitor the Receive Signal Strength Indicator (RSSI) value directly from the management interface. The higher the RSSI value, the stronger the signal.

When you move the antenna during alignment, the radio signal from the remote antenna can be seen to have a strong central main lobe and smaller side lobes. The object of the alignment process is to set the antenna so that it is receiving the strongest signal from the central main lobe.

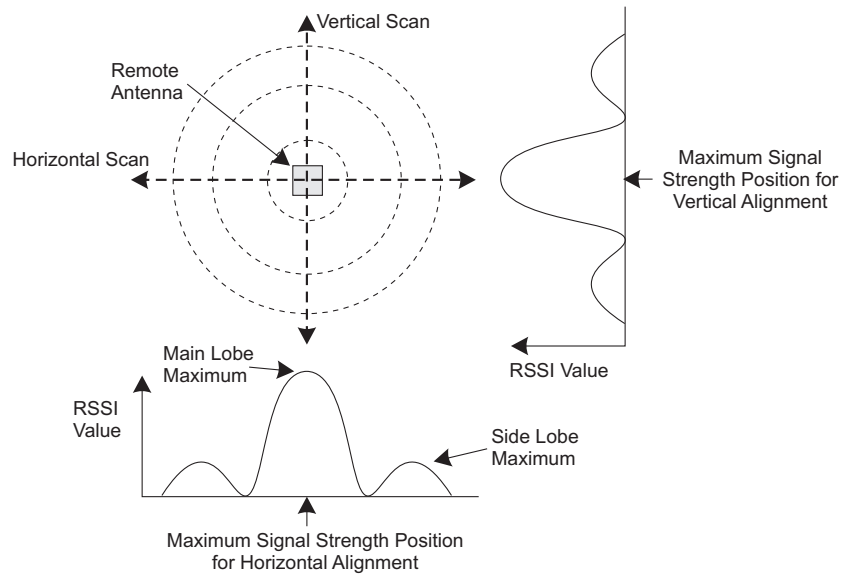

To align the antennas in the link, monitor the signal strength LEDs or the RSSI value in the management interface. Start with one antenna fixed and then perform the following procedure on the other antenna:

Note: The RSSI value can be configured through management interfaces to display a value for specific WDS bridge links.

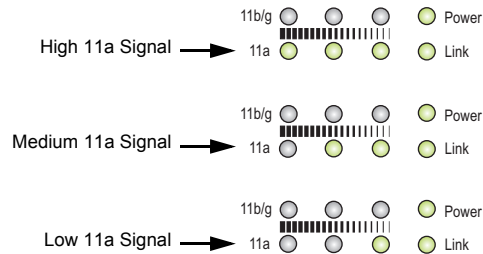

1. Pan the antenna horizontally back and forth while checking the LEDs. If using the pole-mounting bracket with the BSAP-1600, you must rotate the mounting bracket around the pole. Other external antenna brackets may require a different horizontal adjustment.
2. Find the point where the signal is strongest (all LEDs on) and secure the horizontal adjustment in that position.

Note: Sometimes there may not be a central lobe peak because vertical alignment is too far off; only two similar peaks for the side lobes are detected. In this case, fix the antenna so that it is halfway between the two peaks.

3. Loosen the vertical adjustment on the mounting bracket and tilt the antenna slowly up and down while checking the LEDs.

Find the point where the signal is strongest and secure the vertical adjustment in that position.

3)))

Network Configuration

The BSAP-1600 provides access point or bridging services through either the 5 GHz or 2.4 GHz radio interfaces.

The BSAP-1600 can be used just as a normal 802.11a/b/g access point connected to a local wired LAN, providing connectivity and roaming services for wireless clients in an outdoor area. BSAP-1600s can also be used purely as bridges connecting remote LANs. Alternatively, you can employ both access point and bridging functions together, offering a flexible and convenient wireless solution for many applications.

This chapter describes the role of the BSAP-1600 in various wireless network configurations.

Access Point Topologies

Operating as an outdoor access point, the BSAP-1600 is deployed in an integrated configuration with wired Ethernet LANs, providing network access to wireless stations in the wireless coverage area.

The BSAP-1600's radios can support these modes:

- Infrastructure wireless LAN
- Infrastructure wireless LAN with roaming

The 802.11b and 802.11g frequency band, which operates at 2.4 GHz, can easily encounter interference from other 2.4 GHz devices, such as other 802.11b or g wireless devices, cordless phones and microwave ovens. If you experience poor wireless LAN performance, try the following measures:

- Limit any possible sources of radio interference within the service area
- Increase the distance between neighboring BSAP-1600s
- Increase the channel separation of neighboring BSAP-1600s (e.g., up to 3 channels of separation for 802.11b or up to 5 channels for 802.11g)

Infrastructure Wireless LAN

The access point function of the BSAP-1600 provides access to a wired LAN for 802.11a/b/g wireless workstations. An integrated wired/

wireless LAN is called an Infrastructure configuration. A Basic Service Set (BSS) consists of a group of wireless PC users and an BSAP-1600 that is directly connected to the wired LAN. Each wireless PC in a BSS can connect to any computer in its wireless group or access other computers or network resources in the wired LAN infrastructure through the BSAP-1600.

The infrastructure configuration not only extends the accessibility of wireless PCs to the wired LAN, but also increases the effective wireless transmission range for wireless PCs by passing their signals through one or more BSAP-1600s.

A wireless infrastructure can be used for access to a central database, or for connection between mobile workers, as shown in the following figure.

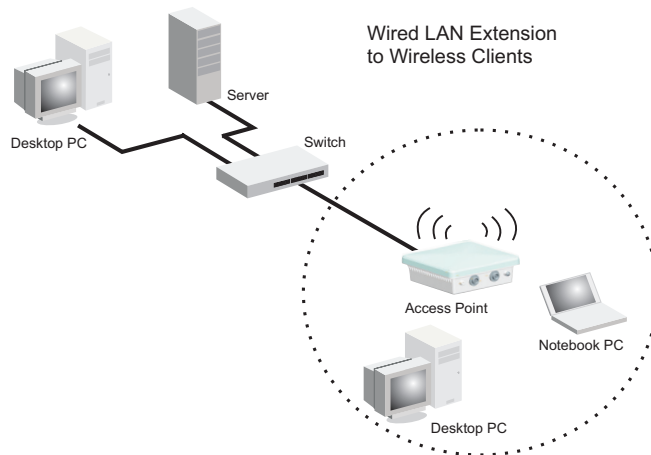

Infrastructure Wireless LAN for Roaming Wireless PCs

The Basic Service Set (BSS) defines the communications domain for each BSAP-1600 and its associated wireless clients. The BSS ID is a 48-bit binary number based on the BSAP-1600's wireless MAC address, and is set automatically and transparently as clients associate with the BSAP-1600. The BSS ID is used in frames sent between the BSAP-1600 and its clients to identify traffic in the service area.

The BSS ID is only set by the BSAP-1600, never by its clients. The clients only need to choose the Service Set Identifier (SSID) that identifies the service set provided by one or more BSAP-1600s. The SSID can be manually configured by the clients, can be detected in an BSAP-1600's beacon, or can be obtained by querying for the identity of the nearest BSAP-1600. For clients that do not need to roam, set the SSID for the wireless card to that used by the BSAP-1600 to which you want to connect.

A wireless infrastructure can also support roaming for mobile workers. More than one BSAP-1600 can be configured to create an Extended Service Set (ESS). By placing the BSAP-1600s so that a continuous coverage area is created, wireless users within this ESS can roam freely. All wireless network card adapters and wireless BSAP-1600s within a specific ESS must be configured with the same SSID.

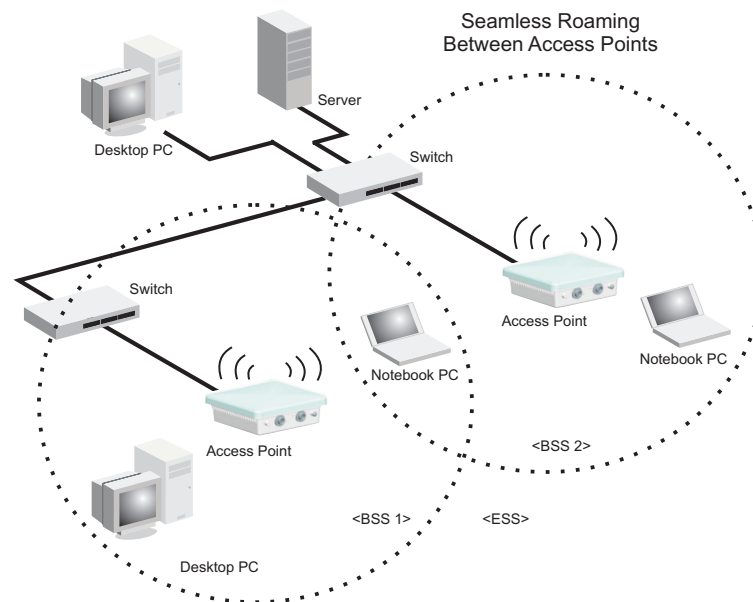

Bridge Link Topologies

The IEEE 802.11 standard defines a Wireless Distribution System (WDS) for bridge connections between BSS areas (access points). The outdoor BSAP-1600 uses WDS to forward traffic on links between BSAP-1600s. Up to 6 WDS links can be specified for a BSAP-1600, which acts as the “Master” in the bridge link network. Other BSAP-1600s support only one WDS link, which must be to the network’s master BSAP-1600.

The BSAP-1600 supports WDS bridge links on either the 5 GHz (802.11a) or 2.4 GHz (802.11b/g) bands and can be used with various external antennas to offer flexible deployment options.

Note: External high-gain panel antennas can be used with the 802.11a and 802.11b/g radios to provide for long-range point-to-point bridge links. While the 8 dBi gain omni antennas can be used for short-range point-to-point and point-to-multipoint links, they’re ideally suited for when the BSAP-1600 is configured for access point mode.

When using WDS on a radio band, only BSAP-1600s can associate to each other. Wireless clients can only associate with the BSAP-1600 using a radio band set to access point mode.

Point-to-Point Configuration

Two BSAP-1600s can form a wireless point-to-point network using external high-gain panel antennas. A point-to-point configuration can provide a link of up to 13 miles (20.8 Km) at 36 Mb/s using the 802.11g radio, or a link of up to 3 miles (4.8 Km) at 36 Mb/s using the 802.11a radio.



Point-to-Multipoint Configuration

The BSAP-1600 can use an omni-directional or panel antenna to connect to as many as 6 other BSAP-1600s in a point-to-multipoint configuration. There can be only one "Master" BSAP-1600 in a bridge link network, all other BSAP-1600s must be configured as nodes.

Using the 5 GHz 8 dBi gain omni-directional antenna, the BSAP-1600 can connect to other BSAP-1600s up to 2 miles, (3.2 Km) away. Using the 13 dBi gain panel antenna, the BSAP-1600 can connect to other BSAP-1600s up to 5.1 miles, (8.2 Km) away.

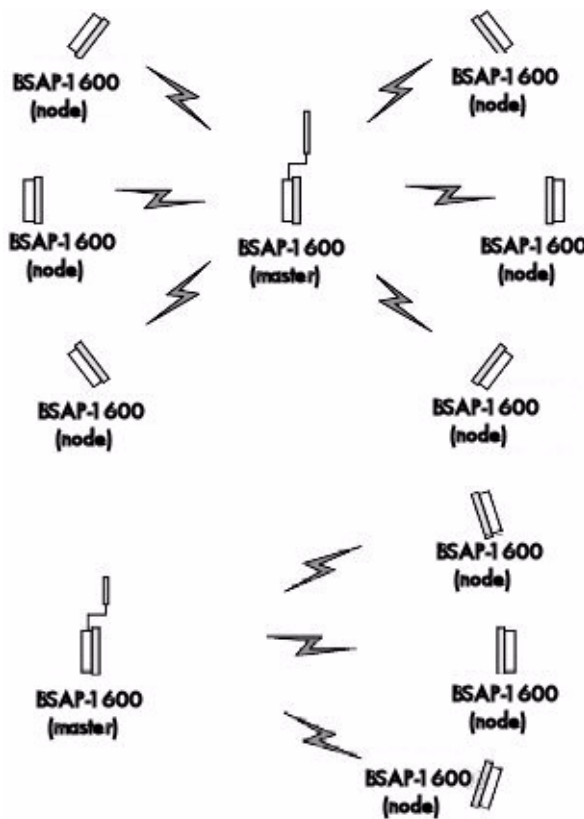

4)))

Bridge Link Planning

The BSAP-1600 supports fixed point-to-point or point-to-multipoint wireless links. A single link between two points can be used to connect a remote site to larger core network. Multiple bridge links can provide a way to connect widespread Ethernet LANs.

For each link in a bridge link network to be reliable and provide optimum performance, some careful site planning is required. This chapter provides guidance and information for planning your BSAP-1600 links.

Note: If you are unsure about setting up your BSAP-1600 links or face a potentially difficult deployment, such as the need for a high mast or tower, use a professional contractor to help you plan and install the equipment.

Data Rates

When you are planning each BSAP-1600 link, take into account the maximum distance and data rates for the various antenna options. A summary is provided in the following table.

Table 4-1: Antenna Approximate maximum link distances

Antenna Model Number	Description	Gain	54 Mb/s	24 Mb/s	6 Mb/s
ANT-005	2.4 GHz Omni	8 dBi	1.5 Mi / 2.4 Km	3.2 Mi / 5.1 Km	4.8 Mi / 7.7 Km
ANT-006	5 GHz Omni	8 dBi	.11 Mi / .18 Km	.9 Mi / 1.4 Km	2 Mi / 3.2 Km
ANT-007	2.4 GHz Panel	14.5 dBi	2.5 Mi / 4 Km	9 Mi / 14.4 Km	20 Mi / 32 Km
ANT-008	5 GHz Panel	13 dBi	.6 Mi / .96 Km	2 Mi / 3.2 Km	5.1 Mi / 8.2 Km

Distances provided in this table are an estimate for a typical deployment and may be reduced by local regulatory limits. For accurate distances, you need to calculate the power link budget for your specific environment.

Radio Path Planning

Although the BSAP-1600 uses IEEE 802.11a radio technology, which is capable of reducing the effect of multipath signals due to obstructions, the BSAP-1600 link requires a “radio line-of-sight” between the two antennas for optimum performance.

The concept of radio line-of-sight involves the area along a radio link path through which the bulk of the radio signal power travels. This area is known as the first Fresnel Zone of the radio link. For a radio link not to be affected by obstacles along its path, no object, including the ground, must intrude within 60% of the first Fresnel Zone.

The following figure illustrates the concept of a good radio line-of-sight.

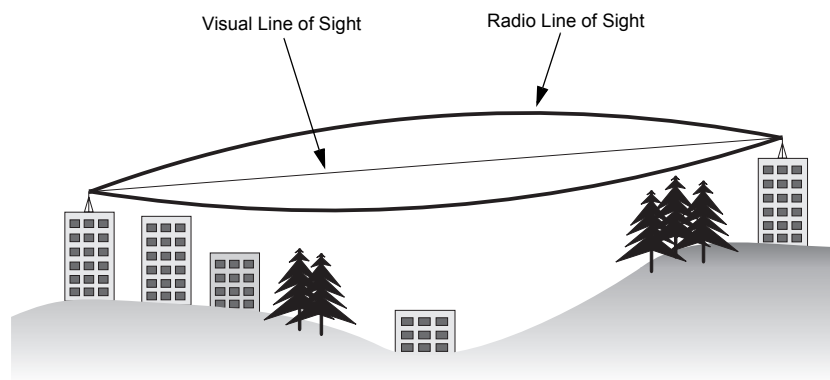

If there are obstacles in the radio path, there may still be a radio link but the quality and strength of the signal will be affected. Calculating the maximum clearance from objects on a path is important as it directly affects the decision on antenna placement and height. It is especially critical for long-distance links, where the radio signal could easily be lost.

Note: For wireless links less than 500 m, the IEEE 802.11a radio signal will tolerate some obstacles in the path and may not even require a visual line of sight between the antennas.

When planning the radio path for a BSAP-1600 link, consider these factors:

- Avoid any partial line-of-sight between the antennas.
- Be cautious of trees or other foliage that may be near the path, or may grow and obstruct the path.
- Be sure there is enough clearance from buildings and that no building construction may eventually block the path.
- Check the topology of the land between the antennas using topographical maps, aerial photos, or even satellite image data (software packages are available that may include this information for your area)
- Avoid a path that may incur temporary blockage due to the movement of cars, trains, or aircraft.

Antenna Height

A reliable wireless link is usually best achieved by mounting the antennas at each end high enough for a clear radio line of sight between them. The minimum height required depends on the distance of the link, obstacles that may be in the path, topology of the terrain, and the curvature of the earth (for links over 3 miles).

For long-distance links, a mast or pole may need to be constructed to attain the minimum required height. Use the following table to estimate the required minimum clearance above the ground or path obstruction.

Table 4-2: Antenna Minimum Clearance

Total Link Distance	Max Clearance for 60% of First Fresnel Zone at 5.8 GHz	Approximate Clearance for Earth Curvature	Total Clearance Required at Mid-point of Link
0.25 mile (402 m)	4.5 ft (1.4 m)	0	4.5 ft (1.4 m)
0.5 mile (805 m)	6.4 ft (1.95 m)	0	6.4 ft (1.95 m)
1 mile (1.6 km)	9 ft (2.7 m)	0	9 ft (2.7 m)
2 miles (3.2 km)	12.7 ft (3.9 m)	0	12.7 ft (3.9 m)
3 miles (4.8 km)	15.6 ft (4.8 m)	1.8 ft (0.5 m)	17.4 ft (5.3 m)
4 miles (6.4 km)	18 ft (5.5 m)	3.2 ft (1.0 m)	21.2 ft (6.5 m)
5 miles (8 km)	20 ft (6.1 m)	5 ft (1.5 m)	25 ft (7.6 m)
7 miles (11.3 km)	24 ft (7.3 m)	9.8 ft (3.0 m)	33.8 ft (10.3 m)
9 miles (14.5 km)	27 ft (8.2 m)	16 ft (4.9 m)	43 ft (13.1 m)
12 miles (19.3 km)	31 ft (9.5 m)	29 ft (8.8 m)	60 ft (18.3 m)
15 miles (24.1 km)	35 ft (10.7 m)	45 ft (13.7 m)	80 ft (24.4 m)
17 miles (27.4 km)	37 ft (11.3 m)	58 ft (17.7 m)	95 ft (29 m)

Note that to avoid any obstruction along the path, the height of the object must be added to the minimum clearance required for a clear radio line-of-sight. Consider the following simple example, illustrated in the figure below.

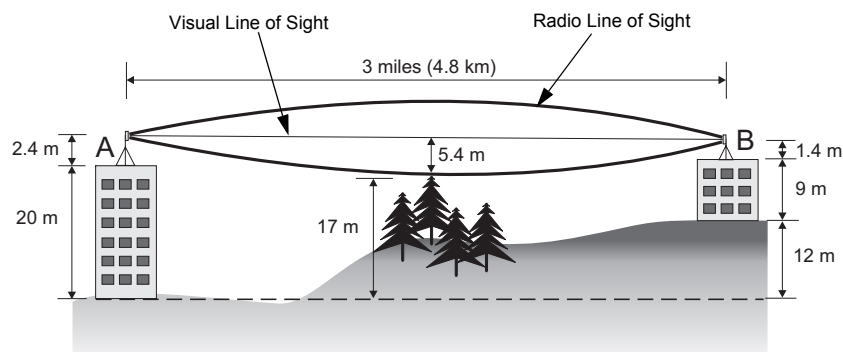

A BSAP-1600 link is deployed to connect building A to a building B, which is located three miles (4.8 km) away. Mid-way between the two buildings is a small tree-covered hill. From the above table it can be seen that for a three-mile link, the object clearance required at the mid-point is 5.3 m (17.4 ft). The tree-tops on the hill are at an elevation of 17 m (56 ft), so the antennas at each end of the link need to be at least 22.3 m (73 ft) high. Building A is six stories high, or 20 m (66 ft), so a 2.3 m (7.5 ft) mast or pole must be constructed on its roof to achieve the required antenna height. Building B is only three stories high, or 9 m (30 ft), but is located at an elevation that is 12 m (39 ft) higher than building A. To mount an antenna at the required height on building B, a mast or pole of only 1.3 m (4.3 ft) is needed.

⚠ Caution: Never construct a radio mast, pole, or tower near overhead power lines.

Note: Local regulations may limit or prevent construction of a high radio mast or tower. If your BSAP-1600 link requires a high radio mast or tower, consult a professional contractor for advice.

Antenna Position and Orientation

Once the required antenna height has been determined, other factors affecting the precise position of the BSAP-1600 must be considered:

- Be sure there are no other radio antennas within 2 m (6 ft) of the BSAP-1600
- Place the BSAP-1600 away from power and telephone lines
- Avoid placing the BSAP-1600 too close to any metallic, reflective surfaces, such as roof-installed air-conditioning equipment, tinted windows, wire fences, or water pipes
- The BSAP-1600 antennas at both ends of the link must be positioned with the same polarization direction, either horizontal or vertical

Antenna Polarization — The BSAP-1600's integrated antenna sends a radio signal that is polarized in a particular direction. The antenna's receive sensitivity is also higher for radio signals that have the same polarization. To maximize the performance of the wireless link, both antennas must be set to the same polarization direction. The antenna polarization is marked on the BSAP-1600, as indicated in the following figure.

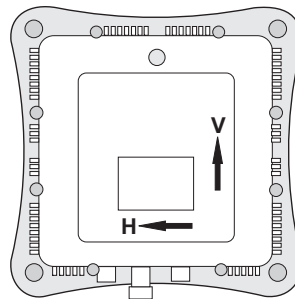

Radio Interference

The avoidance of radio interference is an important part of wireless link planning. Interference is caused by other radio transmissions using the same or an adjacent channel frequency. You should first scan your proposed site using a spectrum analyzer to determine if there are any strong radio signals using the 802.11a channel frequencies. Always use a channel frequency that is furthest away from another signal.

If radio interference is still a problem with your BSAP-1600 link, changing the antenna polarization direction may improve the situation.

Weather Conditions

When planning BSAP-1600 links, you must take into account any extreme weather conditions that are known to affect your location. Consider these factors:

- **Temperature** — The BSAP-1600 is tested for normal operation in temperatures from -40 degrees Centigrade to 65 degrees Centigrade. Operating in temperatures outside of this range may cause the BSAP-1600 to fail.
- **Wind Velocity** — The BSAP-1600 can operate in winds up to 100 MPH and survive higher wind speeds up to 150 MPH. You must consider the known maximum wind velocity and direction at the site and be sure that any supporting structure, such as a pole, mast, or tower, is built to withstand this force.
- **Lightning** — The BSAP-1600 includes its own built-in lightning protection. However, you should make sure that the BSAP-1600, any supporting structure, and cables are all properly grounded. Additional protection using lightning rods, lightning arrestors, or surge suppressors may also be employed.
- **Rain** — The BSAP-1600 is weatherproofed against rain. Also, prolonged heavy rain has no significant effect on the radio signal. However, it is recommended to apply weatherproof sealing tape around the Ethernet port and antenna connectors for extra protection. If moisture enters a connector, it may cause a degradation in performance or even a complete failure of the link.
- **Snow and Ice** — Falling snow, like rain, has no significant effect on the radio signal. However, a build up of snow or ice on antennas may cause the link to fail. In this case, the snow or ice has to be cleared from the antennas to restore operation of the link.

Ethernet Cabling

When a suitable antenna location has been determined, you must plan a cable route from the BSAP-1600 outdoors to the power injector module indoors. Consider these points:

- The Ethernet cable length should never be longer than 100 m (328 ft)
- Determine a building entry point for the cable

- Determine if conduits, bracing, or other structures are required for safety or protection of the cable
- For lightning protection at the power injector end of the cable, consider using a lightning arrester immediately before the cable enters the building

Grounding

- It is important that the BSAP-1600, cables, and any supporting structures are properly grounded. The BSAP-1600 includes a grounding screw for attaching a ground wire. Be sure that grounding is available and that it meets local and national electrical codes.

5)))

Initial Configuration

The BSAP-1600 offers a variety of management options, including a web-based interface, a direct connection to the console port, Telnet, Secure Shell (SSH), or using SNMP software.

The initial configuration steps can be made through the web browser interface or CLI. The BSAP-1600 requests an IP address via DHCP by default. If no response is received from the DHCP server, then the BSAP-1600 uses the default address 192.168.1.1. If this address is not compatible with your network, you can first use the command line interface (CLI) as described below to configure a valid address.

Note: BSAP-1600s sold in countries outside the United States are not configured with a specific country code. You must use the CLI to set the country code and enable wireless operation (Setting the Country Code – BSAP-1600s sold in the United States are configured by default to use only radio channels 1-11 in 802.11b or 802.11g mode as defined by FCC regulations. BSAP-1600s sold in other countries are configured by default without a country code (i.e., 99). You must use the CLI to set the country code. Setting the country code restricts operation of the BSAP-1600 to the radio channels and transmit power levels permitted for wireless networks in the specified country.).

Initial Setup through the Command Line Interface (CLI)

Required Connections

The BSAP-1600 provides an RS-232 serial port that enables a connection to a PC or terminal for monitoring and configuration. Attach a VT100-compatible terminal, or a PC running a terminal emulation program to the BSAP-1600. You can use the console cable provided with this package, or use a cable that complies with the wiring assignments shown in Appendix B.

To connect to the console port, complete the following steps:

1. Connect the console cable to the serial port on a terminal, or a PC running terminal emulation software, and tighten the captive retaining screws on the DB-9 connector.
2. Connect the other end of the cable to the RS-232 serial port on the BSAP-1600.
3. Make sure the terminal emulation software is set as follows:

- Select the appropriate serial port (COM port 1 or 2).
 - Set the data rate to 9600 bps.
 - Set the data format to 8 data bits, 1 stop bit, and no parity.
 - Set flow control to none.
 - Set the emulation mode to VT100.
 - When using HyperTerminal, select Terminal keys, not Windows keys.
4. Once you have set up the terminal correctly, press the [Enter] key to initiate the console connection. The console login screen will be displayed.

For a description of how to use the CLI, see “Using the Command Line Interface” on page 7-1. For a list of all the CLI commands and detailed information on using the CLI, refer to “Command Groups” on page 7-6.

Initial Configuration Steps

Logging In – Enter “admin” for the username. The default password is null, so just press [Enter] at the password prompt. The CLI prompt appears displaying the BSAP-1600’s name.

```
Username: admin
Password:
Enterprise AP#
```

Setting the IP Address – By default, the BSAP-1600 is configured to obtain IP address settings from a DHCP server. If a DHCP server is not available, the IP address defaults to 192.168.1.1, which may not be compatible with your network. You will therefore have to use the command line interface (CLI) to assign an IP address that is compatible with your network.

Type “configure” to enter configuration mode, then type “interface ethernet” to access the Ethernet interface-configuration mode.

```
Enterprise AP#configure
Enterprise AP(config)#interface ethernet
Enterprise AP(config-if)#
```

First type “no ip dhcp” to disable DHCP client mode. Then type “ip address *ip-address netmask gateway*,” where “ip-address” is the BSAP-1600’s IP address, “netmask” is the network mask for the network, and “gateway” is the default gateway router. Check with your system administrator to obtain an IP address that is compatible with your network.

```
Enterprise AP(if-ethernet)#no ip dhcp
Enterprise AP(if-ethernet)#ip address 192.168.2.2
255.255.255.0 192.168.2.254
Enterprise AP(if-ethernet)#
```

After configuring the BSAP-1600's IP parameters, you can access the management interface from anywhere within the attached network. The command line interface can also be accessed using Telnet from any computer attached to the network.

Setting the Country Code – BSAP-1600s sold in the United States are configured by default to use only radio channels 1-11 in 802.11b or 802.11g mode as defined by FCC regulations. BSAP-1600s sold in other countries are configured by default without a country code (i.e., 99). You must use the CLI to set the country code. Setting the country code restricts operation of the BSAP-1600 to the radio channels and transmit power levels permitted for wireless networks in the specified country.

Type "exit" to leave configuration mode. Then type "country ?" to display the list of countries. Select the code for your country, and enter the country command again, following by your country code (e.g., tw for Taiwan).

```
Enterprise AP#country tw
Enterprise AP#
```

Note: Command examples shown later in this manual abbreviate the console prompt to "AP" for simplicity.

Logging In

There are only a few basic steps you need to complete to connect the BSAP-1600 to your corporate network, and provide network access to wireless clients.

The BSAP-1600 can be managed by any computer using a web browser (Internet Explorer 5.0 or above, or Netscape 6.2 or above). Enter the default IP address: `http://192.168.1.1`

Logging In – Enter the username "admin," the password is null, so just press just leave it blank and click LOGIN. For information on configuring a username and password, see "Changing the Password" on page 6-24.

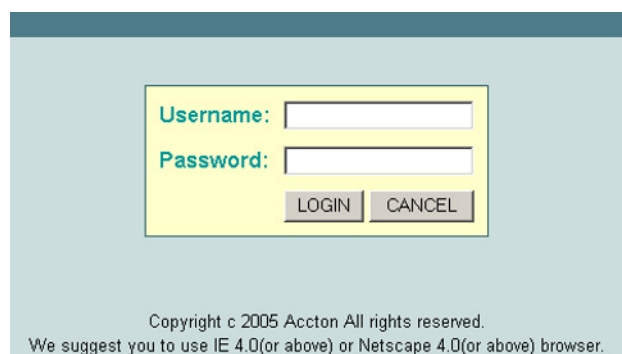

Username:

Password:

LOGIN CANCEL

Copyright c 2005 Accton All rights reserved.
We suggest you to use IE 4.0(or above) or Netscape 4.0(or above) browser.

The home page displays the Main Menu.



6)))

System Configuration

Before continuing with advanced configuration, first complete the initial configuration steps described in Chapter 5, Initial Configuration, to set up an IP address for the BSAP-1600.

The BSAP-1600 can be managed by any computer using a web browser (Internet Explorer 5.0 or above, or Netscape 6.2 or above). Enter the configured IP address of the BSAP-1600, or use the default address: `http://192.168.1.1`

To log into the BSAP-1600, enter the default user name "admin" and then press "LOGIN". When the home page displays, click on Advanced Setup. The following page will display.

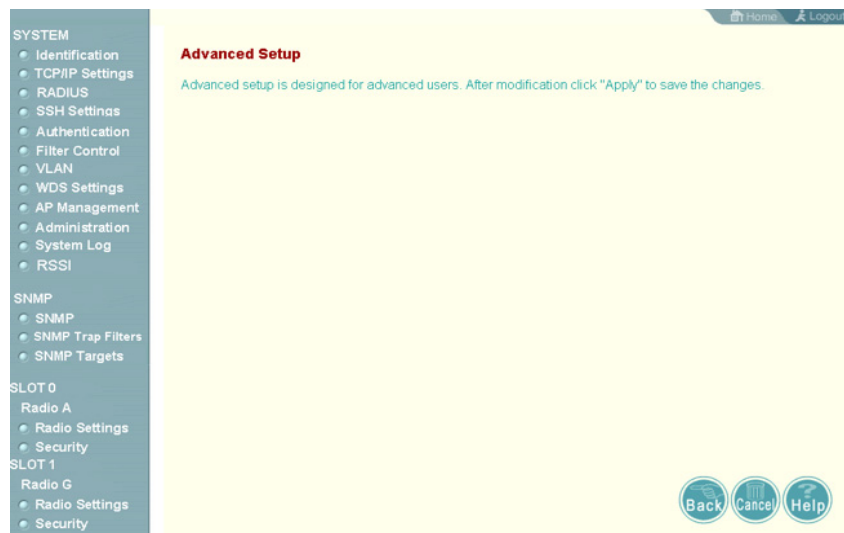

The information in this chapter is organized to reflect the structure of the web screens for easy reference. However, it is recommended that you configure a user name and password as the first step under Administration to control management access to this device (Administration).

Advanced Configuration

The Advanced Configuration pages include the following options.

Table 6-1: Advanced Configuration Pages Menu Options

Menu	Description	Page
System	Configures basic administrative and client access	6-3
Identification	Specifies the host name	6-3
TCP / IP Settings	Configures the IP address, subnet mask, gateway, and domain name servers	6-4
RADIUS	Configures the RADIUS server for wireless client authentication and accounting	6-6
SSH Settings	Configures Secure Shell management access	6-9
Authentication	Configures 802.1x client authentication, with an option for MAC address authentication	6-10
Filter Control	Filters communications between wireless clients, access to the management interface from wireless clients, and traffic matching specific Ethernet protocol types	6-14
VLAN	Enables VLAN support and sets the management VLAN ID	6-16
WDS Settings	Configures bridge or repeater modes for each radio interface and sets spanning tree parameters	6-18
AP Management	Configures access to management interfaces	6-23
Administration	Configures user name and password for management access; upgrades software from local file, FTP or TFTP server; resets configuration settings to factory defaults; and resets the BSAP-1600	6-24
System Log	Controls logging of error messages; sets the system clock via SNTP server or manual configuration	6-28
RSSI	Configures RSSI value display, bridge link distance, and LED display mode	6-32
SNMP	Configures SNMP settings	6-33
SNMP	Controls access to this BSAP-1600 from management stations using SNMP, as well as the hosts that will receive trap messages	6-34
SNMP Trap Filters	Defines trap filters for SNMPv3 users	6-38
SNMP Targets	Specifies SNMPv3 users that will receive trap messages	6-41
Radio Interface A	Configures the IEEE 802.11a interface	6-43
Radio Settings	Configures common radio signal parameters and other settings for each VAP interface (Virtual Access Point technology multiplies the number of Access Points present within the RF footprint of a single physical access device.)	6-57

Table 6-1: Advanced Configuration Pages Menu Options

Security	Enables each virtual access point (VAP) interface, sets the Service Set Identifier (SSID), and configures wireless security	6-59
Radio Interface G	Configures the IEEE 802.11g interface	6-57
Radio Settings	Configures common radio signal parameters and other settings for each VAP (Virtual Access Point) interface.	6-57
Security	Enables each VAP (Virtual Access Point) interface, sets the SSID, and configures wireless security	6-59
Status	Displays information about the BSAP-1600 and wireless clients	6-75
AP Status	Displays configuration settings for the basic system and the wireless interface	6-75
Station Station	Shows the wireless clients currently associated with the BSAP-1600	6-77
Event Logs	Shows log messages stored in memory	6-79

System

Identification

The system name for the BSAP-1600 can be left at its default setting. However, modifying this parameter can help you to more easily distinguish different devices in your network.

System Name – An alias for the BSAP-1600, enabling the device to be uniquely identified on the network. (Default: Enterprise Wireless AP; Range: 1-32 characters)

CLI Commands for System Identification – Enter the global configuration mode, and use the **system name** command to specify a new system name. Then return to

the Exec mode, and use the **show system** command to display the changes to the system identification settings.

```

Enterprise AP#config                               6-8
Enter configuration commands, one per line.
Enterprise AP(config)#system name R&D             6-14
Enterprise AP(config)#end                         6-90
Enterprise AP#show system                         6-24

System Information
=====
Serial Number      :
System Up time     : 0 days, 0 hours, 32 minutes, 22 seconds
System Name       : Enterprise Wireless AP
System Location    :
System Contact     : Contact
System Country Code : US - UNITED STATES
MAC Address       : 00-12-CF-12-34-60
Radio A MAC Address : 00-12-CF-12-34-61
Radio G MAC Address : 00-12-CF-12-34-65
IP Address        : 192.168.1.1
Subnet Mask       : 255.255.255.0
Default Gateway   : 0.0.0.0
VLAN State        : DISABLED
Management VLAN ID(AP) : 1
IAPP State        : ENABLED
DHCP Client       : ENABLED
HTTP Server       : ENABLED
HTTP Server Port  : 80
HTTP Session Timeout : 300 sec(s)
HTTPS Server      : ENABLED
HTTPS Server Port : 443
Slot Status       : Dual band(a/g)
Boot Rom Version  : v1.1.6
Software Version  : v4.3.3.1b05
SSH Server        : ENABLED
SSH Server Port   : 22
Telnet Server     : ENABLED
DHCP Relay        : DISABLED
=====
Enterprise AP#

```

TCP / IP Settings

Configuring the BSAP-1600 with an IP address expands your ability to manage the BSAP-1600. A number of BSAP-1600 features depend on IP addressing to operate.

Note: You can use the web browser interface to access IP addressing only if the BSAP-1600 already has an IP address that is reachable through your network.

By default, the BSAP-1600 will be automatically configured with IP settings from a Dynamic Host Configuration Protocol (DHCP) server. However, if you are not using a DHCP server to configure IP addressing, use the CLI to manually configure the initial IP values (“Initial Configuration Steps” on page 5-2). After you have network access to the BSAP-1600, you can use the web browser interface to modify the initial IP configuration, if needed.

Note: If there is no DHCP server on your network, or DHCP fails, the BSAP-1600 will automatically start up with a default IP address of 192.168.1.1.

Home Logout

TCP / IP Settings

DHCP Client

Enable The Access Point will obtain the IP Address from the DHCP Server

Disable The Access Point will use the following IP setup

IP Address	192.168.1.1
Subnet Mask	255.255.255.0
Default Gateway	0.0.0.0
Primary DNS Address	0.0.0.0
Secondary DNS Address	0.0.0.0

Apply Cancel Help

DHCP Client (Enable) – Select this option to obtain the IP settings for the BSAP-1600 from a DHCP (Dynamic Host Configuration Protocol) server. The IP address, subnet mask, default gateway, and Domain Name Server (DNS) address are dynamically assigned to the BSAP-1600 by the network DHCP server. (Default: Enabled)

DHCP Client (Disable) – Select this option to manually configure a static address for the BSAP-1600.

- **IP Address:** The IP address of the BSAP-1600. Valid IP addresses consist of four decimal numbers, 0 to 255, separated by periods.
- **Subnet Mask:** The mask that identifies the host address bits used for routing to specific subnets.
- **Default Gateway:** The default gateway is the IP address of the router for the BSAP-1600, which is used if the requested destination address is not on the local subnet.

If you have management stations, DNS, RADIUS, or other network servers located on another subnet, type the IP address of the default gateway router in the text field provided. Otherwise, leave the address as all zeros (0.0.0.0).

- **Primary and Secondary DNS Address:** The IP address of Domain Name Servers on the network. A DNS maps numerical IP addresses to domain names and can be used to identify network hosts by familiar names instead of the IP addresses.

If you have one or more DNS servers located on the local network, type the IP addresses in the text fields provided. Otherwise, leave the addresses as all zeros (0.0.0.0).

CLI Commands for TCP/IP Settings – From the global configuration mode, enter the interface configuration mode with the **interface ethernet** command. Use the **ip dhcp** command to enable the DHCP client, or **no ip dhcp** to disable it. To manually configure an address, specify the new IP address, subnet mask, and

default gateway using the **ip address** command. To specify DNS server addresses use the **dns server** command. Then use the **show interface ethernet** command from the Exec mode to display the current IP settings.

```

Enterprise AP(config)#interface ethernet                               6-90
Enter Ethernet configuration commands, one per line.
Enterprise AP(if-ethernet)#no ip dhcp                                6-92
Enterprise AP(if-ethernet)#ip address 192.168.1.2
255.255.255.0 192.168.1.253                                           6-91
Enterprise AP(if-ethernet)#dns primary-server 192.168.1.55          6-91
Enterprise AP(if-ethernet)#dns secondary-server 10.1.0.55           6-91
Enterprise AP(config)#end                                           6-8
Enterprise AP#show interface ethernet                                6-94
Ethernet Interface Information
=====
IP Address      : 192.168.1.2
Subnet Mask     : 255.255.255.0
Default Gateway : 192.168.1.253
Primary DNS     : 192.168.1.55
Secondary DNS   : 10.1.0.55
Admin status    : Up
Operational status : Up
=====
Enterprise AP#

```

RADIUS

Remote Authentication Dial-in User Service (RADIUS) is an authentication protocol that uses software running on a central server to control access to RADIUS-aware devices on the network. An authentication server contains a database of user credentials for each user that requires access to the network.

A primary RADIUS server must be specified for the BSAP-1600 to implement IEEE 802.1x network access control and Wi-Fi Protected Access (WPA) wireless security. A secondary RADIUS server may also be specified as a backup should the primary server fail or become inaccessible.

In addition, the configured RADIUS server can also act as a RADIUS Accounting server and receive user-session accounting information from the BSAP-1600. RADIUS Accounting can be used to provide valuable information on user activity in the network.

Note: This guide assumes that you have already configured RADIUS server(s) to support the BSAP-1600. Configuration of RADIUS server software is beyond the scope of this guide, refer to the documentation provided with the RADIUS server software.

[Home](#)
[Logout](#)

RADIUS

MAC Address Format

<input checked="" type="radio"/> No Delimiter	xxxxxxxxxxxx
<input type="radio"/> Single Dash	xxxxxx-xxxxxx
<input type="radio"/> Multi-Dash	xx-xx-xx-xx-xx-xx
<input type="radio"/> Multi-Colon	xx:xx:xx:xx:xx:xx

VLAN ID Format



<input type="radio"/> Ascii
<input checked="" type="radio"/> Hex

Primary RADIUS Server Setup

IP Address	0.0.0.0
Port	1812
Key	xxxxxxxx
Timeout (seconds)	5
Retransmit attempts	3
Accounting Port	0
Interim Update Timeout	3600

Secondary RADIUS Server Setup

IP Address	0.0.0.0
Port	1812
Key	xxxxxxxx
Timeout (seconds)	5
Retransmit attempts	3
Accounting Port	0
Interim Update Timeout	3600

MAC Address Format – MAC addresses can be specified in one of four formats, using no delimiter, with a single dash delimiter, with multiple dash delimiters, and with multiple colon delimiters.

VLAN ID Format – A VLAN ID (a number between 1 and 4094) can be assigned to each client after successful authentication using IEEE 802.1x and a central RADIUS server. The user VLAN IDs must be configured on the RADIUS server for each user authorized to access the network. VLAN IDs can be entered as hexadecimal numbers or as ASCII strings.

Primary Radius Server Setup – Configure the following settings to use RADIUS authentication on the BSAP-1600.

- Radius Status: Enabling Radius Status allows the settings of RADIUS authentication. (Default: Enable)
- IP Address: Specifies the IP address or host name of the RADIUS server.
- Port: The UDP port number used by the RADIUS server for authentication messages. (Range: 1024-65535; Default: 1812)
- Key: A shared text string used to encrypt messages between the BSAP-1600 and the RADIUS server. Be sure that the same text string is specified on the RADIUS server. Do not use blank spaces in the string. (Maximum length: 255 characters)
- Timeout: Number of seconds the BSAP-1600 waits for a reply from the RADIUS server before resending a request. (Range: 1-60 seconds; Default: 5)
- Retransmit attempts: The number of times the BSAP-1600 tries to resend a request to the RADIUS server before authentication fails. (Range: 1-30; Default: 3)
- Accounting Port: The RADIUS Accounting server UDP port used for accounting messages. (Range: 0 or 1024-65535; Default: 0, disabled)
- Interim Update Timeout: The interval between transmitting accounting updates to the RADIUS server. (Range: 60-86400; Default: 3600 seconds)

Note: For the Timeout and Retransmit attempts fields, accept the default values unless you experience problems connecting to the RADIUS server over the network.

Secondary Radius Server Setup – Configure a secondary RADIUS server to provide a backup in case the primary server fails. The BSAP-1600 uses the secondary server if the primary server fails or becomes inaccessible. Once the BSAP-1600 switches over to the secondary server, it periodically attempts to establish communication again with primary server. If communication with the primary server is re-established, the secondary server reverts to a backup role.

CLI Commands for RADIUS – From the global configuration mode, use the **radius-server address** command to specify the address of the primary or secondary RADIUS servers. (The following example configures the settings for the primary RADIUS server.) Configure the other parameters for the RADIUS server. Then use

the **show show radius** command from the Exec mode to display the current settings for the primary and secondary RADIUS servers.

```

Enterprise AP(config)#radius-server address 192.168.1.25      6-60
Enterprise AP(config)#radius-server port 1812                6-61
Enterprise AP(config)#radius-server key green                6-61
Enterprise AP(config)#radius-server timeout 10               6-62
Enterprise AP(config)#radius-server retransmit 5             6-62
Enterprise AP(config)#radius-server port-accounting 1813     6-63
Enterprise AP(config)#radius-server timeout-interim 500     6-63
Enterprise AP(config)#exit
Enterprise AP#show radius                                    6-65

Radius Server Information
=====
IP          : 192.168.1.25
Port       : 1812
Key        : *****
Retransmit : 5
Timeout    : 10
Radius MAC format : no-delimiter
Radius VLAN format : HEX
=====

Radius Secondary Server Information
=====
IP          : 0.0.0.0
Port       : 1812
Key        : *****
Retransmit : 3
Timeout    : 5
Radius MAC format : no-delimiter
Radius VLAN format : HEX
=====
Enterprise AP#

```

SSH Settings

Telnet is a remote management tool that can be used to configure the BSAP-1600 from anywhere in the network. However, Telnet is not secure from hostile attacks. The Secure Shell (SSH) can act as a secure replacement for Telnet. The SSH protocol uses generated public keys to encrypt all data transfers passing between the BSAP-1600 and SSH-enabled management station clients and ensures that data traveling over the network arrives unaltered. Clients can then securely use the local user name and password for access authentication.

Note that SSH client software needs to be installed on the management station to access the BSAP-1600 for management via the SSH protocol.

Note: The BSAP-1600 supports only SSH version 2.0.

Note: After boot up, the SSH server needs about two minutes to generate host encryption keys. The SSH server is disabled while the keys are being generated.

SSH Settings *Telnet Server Status* – Enables or disables the Telnet server. (Default: Enabled)

SSH Server Status – Enables or disables the SSH server. (Default: Enabled)

SSH Server Port – Sets the UDP port for the SSH server. (Range: 1-65535; Default: 22)

CLI Commands for SSH – To enable the SSH server, use the **ip ssh-server enable** command from the CLI Ethernet interface configuration mode. To set the SSH server UDP port, use the **ip ssh-server port** command. To view the current settings, use the **show system** command from the CLI Exec mode (not shown in the following example).

```
Enterprise AP(if-ethernet)#no ip telnet-server      6-17
Enterprise AP(if-ethernet)#ip ssh-server enable    6-16
Enterprise AP(if-ethernet)#ip ssh-server port 1124 6-16
Enterprise AP(if-ethernet)#exit
Enterprise AP(if-ethernet)#configure
```

Authentication

Wireless clients can be authenticated for network access by checking their MAC address against the local database configured on the BSAP-1600, or by using a database configured on a central RADIUS server. Alternatively, authentication can be implemented using the IEEE 802.1x network access control protocol.

A client's MAC address provides relatively weak user authentication, since MAC addresses can be easily captured and used by another station to break into the network. Using 802.1x provides more robust user authentication using user names and passwords or digital certificates. You can configure the BSAP-1600 to use both MAC address and 802.1x authentication, with client station MAC authentication occurring prior to IEEE 802.1x authentication. However, it is better to choose one or the other, as appropriate.

Take note of the following points before configuring MAC address or 802.1x authentication:

- Use MAC address authentication for a small network with a limited number of users. MAC addresses can be manually configured on the BSAP-1600 itself without the need to set up a RADIUS server, but managing a large number of MAC addresses across many BSAP-1600s is very cumbersome. A RADIUS

server can be used to centrally manage a larger database of user MAC addresses.

- Use IEEE 802.1x authentication for networks with a larger number of users and where security is the most important issue. When using 802.1x authentication, a RADIUS server is required in the wired network to centrally manage the credentials of the wireless clients. It also provides a mechanism for enhanced network security using dynamic encryption key rotation or W-Fi Protected Access (WPA).

Note: If you configure RADIUS MAC authentication together with 802.1x, RADIUS MAC address authentication is performed prior to 802.1x authentication. If RADIUS MAC authentication succeeds, then 802.1x authentication is performed. If RADIUS MAC authentication fails, 802.1x authentication is not performed.

- The BSAP-1600 can also operate in a 802.1x supplicant mode. This enables the BSAP-1600 itself to be authenticated with a RADIUS server using a configured MD5 user name and password. This prevents rogue access points from gaining access to the network.

Home Logout

Authentication

MAC Authentication :

802.1x supplicant : Disable Enable

Username

Password

Local MAC Authentication :

System Default Deny Allow

MAC Authentication Settings :

MAC Address	Permission	Update
<input type="text"/>	<input type="radio"/> Deny <input checked="" type="radio"/> Allow <input type="radio"/> Delete	<input type="button" value="Update"/>

MAC Authentication Table :

Number	MAC Address	Permission
--------	-------------	------------

Apply Cancel Help

MAC Authentication – You can configure a list of the MAC addresses for wireless clients that are authorized to access the network. This provides a basic level of authentication for wireless clients attempting to gain access to the network. A database of authorized MAC addresses can be stored locally on the BSAP-1600 or remotely on a central RADIUS server.
(Default: Disabled)

- Disabled: No checks are performed on an associating station's MAC address.

- **Local MAC:** The MAC address of the associating station is compared against the local database stored on the BSAP-1600. Use the Local MAC Authentication section of this web page to set up the local database, and configure all BSAP-1600s in the wireless network service area with the same MAC address database.
- **RADIUS MAC:** The MAC address of the associating station is sent to a configured RADIUS server for authentication. When using a RADIUS authentication server for MAC address authentication, the server must first be configured in the Radius window (see "RADIUS" on page 6-6). The database of MAC addresses and filtering policy must be defined in the RADIUS server.

Note: MAC addresses on the RADIUS server can be entered in four different formats (see "RADIUS" on page 6-6).

802.1x Supplicant – The BSAP-1600 can also operate in a 802.1x supplicant mode. This enables the BSAP-1600 itself to be authenticated with a RADIUS server using a configured MD5 user name and password. This prevents rogue access points from gaining access to the network.

Local MAC Authentication – Configures the local MAC authentication database. The MAC database provides a mechanism to take certain actions based on a wireless client's MAC address. The MAC list can be configured to allow or deny network access to specific clients.

- **System Default:** Specifies a default action for all unknown MAC addresses (that is, those not listed in the local MAC database).
 - Deny: Blocks access for all MAC addresses except those listed in the local database as "Allow."
 - Allow: Permits access for all MAC addresses except those listed in the local database as "Deny."
- **MAC Authentication Settings:** Enters specified MAC addresses and permissions into the local MAC database.
 - **MAC Address:** Physical address of a client. Enter six pairs of hexadecimal digits separated by hyphens; for example, 00-90-D1-12-AB-89.
 - **Permission:** Select Allow to permit access or Deny to block access. If Delete is selected, the specified MAC address entry is removed from the database.
 - **Update:** Enters the specified MAC address and permission setting into the local database.
- **MAC Authentication Table:** Displays current entries in the local MAC database.

CLI Commands for *Local MAC Authentication* – Use the **mac-authentication server** command from the global configuration mode to enable local MAC authentication. Use the **mac-authentication session-timeout** command to set the authentication interval, and **web-redirect** command to enable web-based authentication for service billing. Set the default action for MAC addresses not in the local table using the **address filter default** command, then enter MAC addresses in the local table using the **address filter entry** command. To remove an

entry from the table, use the **address filter delete** command. To display the current settings, use the **show authentication** command from the Exec mode.

```

Enterprise AP(config)#mac-authentication server local          6-73
Enterprise AP(config)#mac-authentication session-timeout 5    6-73
Enterprise AP(config)#web-redirect                             6-20
Enterprise AP(config)#address filter default denied           6-71
Enterprise AP(config)#address filter entry
  00-70-50-cc-991a denied                                     6-72
Enterprise AP(config)#address filter entry
  00-70-50-cc-991b allowed
Enterprise AP(config)#address filter entry
  00-70-50-cc-991c allowed
Enterprise AP(config)#address filter delete
  00-70-50-cc-991c                                          6-72
Enterprise AP(config)#exit
Enterprise AP#show authentication                             6-69

Authentication Information
=====
MAC Authentication Server      : LOCAL
MAC Auth Session Timeout Value : 0 min
802.1x supplicant              : DISABLED
802.1x supplicant user         : EMPTY
802.1x supplicant password     : EMPTY
Address Filtering               : DENIED

System Default : ALLOW addresses not found in filter table.
Filter Table

MAC Address      Status
-----
00-70-50-cc-99-1a  DENIED
00-70-50-cc-99-1b  ALLOWED
=====
Enterprise AP#

```

CLI Commands for *RADIUS MAC Authentication* – Use the **mac-authentication server** command from the global configuration mode to enable remote MAC authentication. Set the timeout value for re-authentication using the **mac-authentication session-timeout** command. Be sure to also configure connection settings for the RADIUS server (not shown in the following example). To display the current settings, use the **show authentication** command from the Exec mode.

```

Enterprise AP(config)#mac-authentication server remote          6-73
Enterprise AP(config)#mac-authentication
  session-timeout 300                                         6-73
Enterprise AP(config)#exit
Enterprise AP#show authentication                             6-69

Authentication Information
=====
MAC Authentication Server      : REMOTE
MAC Auth Session Timeout Value : 300 min
802.1x supplicant              : DISABLED
802.1x supplicant user         : EMPTY
802.1x supplicant password     : EMPTY
Address Filtering               : DENIED

System Default : DENY addresses not found in filter table.
Filter Table

MAC Address      Status
-----
00-70-50-cc-99-1a  DENIED
00-70-50-cc-99-1b  ALLOWED
=====
Enterprise AP#

```

CLI Command for *802.1x Supplicant* – To configure the BSAP-1600 to operate as a 802.1x supplicant, first use the **802.1x supplicant user** command to set a user name and password for the BSAP-1600, then use the **802.1x supplicant**

command to enable the feature. To display the current settings, use the **show authentication** command from the Exec mode (not shown in the following example)

```
Enterprise AP(config)#802.1x supplicant user secureAP dot1xpass 6-69
Enterprise AP(config)#802.1x supplicant 6-69
Enterprise AP(config)#
```

Filter Control

The BSAP-1600 can employ network traffic frame filtering to control access to network resources and increase security. You can prevent communications between wireless clients and prevent BSAP-1600 management from wireless clients. Also, you can block specific Ethernet traffic from being forwarded by the BSAP-1600.

Filter Control

Inter Client STAs Communication Filter :

Disable
 Prevent intra VAP client communication
 Prevent inter and intra VAP client communication

AP Management Filter : Disable Enable (Prevent AP management via wireless client.)

Uplink Port MAC Address Filtering Status : Disable Enable

Ethernet Type Filter : Disable Enable

Local Management	ISO Designator	Status
Aironet_DDP	0x872d	<input checked="" type="radio"/> OFF <input type="radio"/> ON
Appletalk_ARP	0x80f3	<input checked="" type="radio"/> OFF <input type="radio"/> ON
ARP	0x0806	<input checked="" type="radio"/> OFF <input type="radio"/> ON
Banyan	0x0bad	<input checked="" type="radio"/> OFF <input type="radio"/> ON
Berkeley_Trailer_Negotiation	0x1000	<input checked="" type="radio"/> OFF <input type="radio"/> ON
CDP	0x2000	<input checked="" type="radio"/> OFF <input type="radio"/> ON
DEC_LAT	0x6004	<input checked="" type="radio"/> OFF <input type="radio"/> ON

Inter Client STAs Communication Filter – Sets the global mode for wireless-to-wireless communications between clients associated to Virtual AP (VAP) interfaces on the BSAP-1600. (Default: Prevent Inter and Intra VAP client Communication)

- Disabled: All clients can communicate with each other through the BSAP-1600.
- Prevent Intra VAP client communication: When enabled, clients associated with a specific VAP interface cannot establish wireless communications with each other. Clients can communicate with clients associated to other VAP interfaces.
- Prevent Inter and Intra VAP client communication: When enabled, clients cannot establish wireless communications with any other client, either those associated to the same VAP interface or any other VAP interface.

AP Management Filter – Controls management access to the BSAP-1600 from wireless clients. Management interfaces include the web, Telnet, or SNMP. (Default: Disabled)

- Disabled: Allows management access from wireless clients.
- Enabled: Blocks management access from wireless clients.

Uplink Port MAC Address Filtering Status – Prevents traffic with specified source MAC addresses from being forwarded to wireless clients through the BSAP-1600. You can add a maximum of four MAC addresses to the filter table. (Default: Disabled)

- MAC Address: Specifies a MAC address to filter, in the form xx-xx-xx-xx-xx-xx.
- Permission: Adds or deletes a MAC address from the filtering table.

Ethernet Type Filter – Controls checks on the Ethernet type of all incoming and outgoing Ethernet packets against the protocol filtering table. (Default: Disabled)

- Disabled: BSAP-1600 does not filter Ethernet protocol types.
- Enabled: BSAP-1600 filters Ethernet protocol types based on the configuration of protocol types in the filter table. If the status of a protocol is set to "ON," the protocol is filtered from the BSAP-1600.

Note: Ethernet protocol types not listed in the filtering table are always forwarded by the BSAP-1600.

Ethernet Type Filter – Enables or disables Ethernet filtering on the port. (Default: Disabled)

CLI Commands for Bridge Filtering – Use the **filter local-bridge** command from the global configuration mode to prevent wireless-to-wireless communications through the BSAP-1600. Use the **filter ap-manage** command to restrict management access from wireless clients. To configure Ethernet protocol filtering, use the **filter ethernet-type enable** command to enable filtering and the **filter ethernet-type protocol** command to define the protocols that you want to filter. To remove an entry from the table, use the **address filter delete** command. To display the current settings, use the **show filters** command from the Exec mode.

```

Enterprise AP(config)#filter local-bridge           6-75
Enterprise AP(config)#filter ap-manage             6-75
Enterprise AP(config)#filter uplink enable        6-76
Enterprise AP(config)#filter uplink add 00-12-34-56-78-9a 6-76
Enterprise AP(config)#filter ethernet-type enable 6-76
Enterprise AP(config)#filter ethernet-type protocol ARP 6-77
Enterprise AP(config)#exit
Enterprise AP#show filters                         6-78

Protocol Filter Information
=====
Local Bridge           :ENABLED
AP Management          :ENABLED
Ethernet Type Filter  :ENABLED

Enabled Protocol Filters
-----
Protocol: ARP           ISO: 0x0806
=====
Enterprise AP#

```

VLAN

The BSAP-1600 can employ VLAN tagging support to control access to network resources and increase security. VLANs separate traffic passing between the BSAP-1600, associated clients, and the wired network. There can be a VLAN assigned to each associated client, a default VLAN for each VAP (Virtual Access Point) interface, and a management VLAN for the BSAP-1600.

Note the following points about the BSAP-1600's VLAN support:

- The management VLAN is for managing the BSAP-1600 through remote management tools, such as the web interface, SSH, SNMP, or Telnet. The BSAP-1600 only accepts management traffic that is tagged with the specified management VLAN ID.
- All wireless clients associated to the BSAP-1600 are assigned to a VLAN. If IEEE 802.1x is being used to authenticate wireless clients, specific VLAN IDs can be configured on the RADIUS server to be assigned to each client. If a client is not assigned to a specific VLAN or if 802.1x is not used, the client is assigned to the default VLAN for the VAP interface with which it is associated. The BSAP-1600 only allows traffic tagged with assigned VLAN IDs or default VLAN IDs to access clients associated on each VAP interface.
- When VLAN support is enabled on the BSAP-1600, traffic passed to the wired network is tagged with the appropriate VLAN ID, either an assigned client VLAN ID, default VLAN ID, or the management VLAN ID. Traffic received from the wired network must also be tagged with one of these known VLAN IDs. Received traffic that has an unknown VLAN ID or no VLAN tag is dropped.
- When VLAN support is disabled, the BSAP-1600 does not tag traffic passed to the wired network and ignores the VLAN tags on any received frames.

Note: Before enabling VLAN tagging on the BSAP-1600, be sure to configure the attached network switch port to support tagged VLAN frames from the BSAP-1600's management VLAN ID, default VLAN IDs, and other client VLAN IDs. Otherwise, connectivity to the BSAP-1600 will be lost when you enable the VLAN feature.

Using IEEE 802.1x and a central RADIUS server, up to 64 VLAN IDs can be mapped to specific wireless clients, allowing users to remain within the same VLAN as they move around a campus site. This feature can also be used to control access to network resources from clients, thereby improving security.

A VLAN ID (1-4094) can be assigned to a client after successful IEEE 802.1x authentication. The client VLAN IDs must be configured on the RADIUS server for each user authorized to access the network. If a client does not have a configured VLAN ID on the RADIUS server, the BSAP-1600 assigns the client to the configured default VLAN ID for the VAP (Virtual Access Point) interface.

Note: When using IEEE 802.1x to dynamically assign VLAN IDs, the BSAP-1600 must have 802.1x authentication enabled and a RADIUS server configured. Wireless clients must also support 802.1x client software.

When setting up VLAN IDs for each user on the RADIUS server, be sure to use the RADIUS attributes and values as indicated in the following table.

Table 6-2: RADIUS Attributes and Values for VLAN ID Setup

Number	RADIUS Attribute	Value
64	Tunnel-Type	VLAN (13)
65	Tunnel-Medium-Type	802
81	Tunnel-Private-Group-ID	VLANID (1 to 4094 as hexadecimal or string)

VLAN IDs on the RADIUS server can be entered as hexadecimal digits or a string (see “radius-server vlan-format” on page 7-54).

Note: The specific configuration of RADIUS server software is beyond the scope of this guide. Refer to the documentation provided with the RADIUS server software.

VLAN Classification – Enables or disables VLAN tagging support on the BSAP-1600.

Native VLAN ID – The VLAN ID that traffic must have to be able to manage the BSAP-1600. (Range 1-4094; Default: 1)

WDS Settings

Each BSAP-1600 radio interface can be configured to operate in a bridge or repeater mode, which allows it to forward traffic directly to other BSAP-1600s. To set up bridge links between BSAP-1600s, you must configure the wireless Distribution System (WDS) forwarding table by specifying the wireless MAC address of all BSAP-1600s to which you want to forward traffic. Up to six WDS bridge or repeater links can be specified for each BSAP-1600 in the bridge link network.

The Spanning Tree Protocol (STP) can be used to detect and disable network loops, and to provide backup links between bridges. This allows a BSAP-1600 to interact with other bridging devices (that is, an STP-compliant switch, bridge or router) in your network to ensure that only one route exists between any two stations on the network, and provide backup links which automatically take over when a primary link goes down.

The screenshot shows a web-based configuration interface for RSSI settings. At the top right, there are 'Home' and 'Logout' links. The main content is organized into several sections:

- RSSI Section:**
 - 'Auto Refresh' with radio buttons for 'Disable' (selected) and 'Enable'.
 - 'Ambient Noise Floor' with two rows: 'Radio 11a' and 'Radio 11g', both set to '0 dBm'.
 - '802.11a Interface' with 'RSSI Value' (input field: 0) and 'Port Number' (dropdown menu).
 - '802.11g Interface' with 'RSSI Value' (input field: 0) and 'Port Number' (dropdown menu).
- Distance Section:**
 - '802.11a Interface' with 'Mode' (radio buttons: 'Normal' selected, 'Turbo') and '11a Distance' (input field: 00 KM).
 - '802.11g Interface' with 'Mode' (radio buttons: 'Normal' selected, 'Turbo') and '11g Distance' (input field: 00 KM).
- LED Status Section:**
 - '802.11a Interface' with 'Mode' (radio buttons: 'AP Traffic' selected, 'Bridge RSSI') and 'Bridge Port' (radio buttons: 1, 2, 3, 4, 5, 6).
 - '802.11g Interface' with 'Mode' (radio buttons: 'AP Traffic' selected, 'Bridge RSSI') and 'Bridge Port' (radio buttons: 1, 2, 3, 4, 5, 6).

At the bottom right, there are three circular buttons: 'Apply', 'Cancel', and 'Help'.

WDS Bridge – Up to six WDS bridge or repeater links (MAC addresses) per radio interface can be specified for each BSAP-1600 in the bridge link network. One BSAP-1600 only must be configured as the “root bridge” in the wireless network. The root bridge is the BSAP-1600 connected to the main core of the

wired LAN. Other bridges need to specify one "Parent" link to the root bridge or to a bridge connected to the root bridge. The other five WDS links are available as "Child" links to other bridges.

- *Bridge Role* – Each radio interface can be set to operate in one of the following four modes: (Default: AP)
 - AP (Access Point): Operates as an access point for wireless clients, providing connectivity to a wired LAN.
 - Bridge: Operates as a bridge to other BSAP-1600s. The "Parent" link to the root bridge must be configured. Up to five other "Child" links are available to other bridges.
 - Repeater: Operates as a wireless repeater, extending the range for remote wireless clients and connecting them to the root bridge. The "Parent" link to the root bridge must be configured. In this mode, traffic is not forwarded to the Ethernet port from the radio interface.
 - Root Bridge: Operates as the root bridge in the bridge link network. Up to six "Child" links are available to other bridges in the network.
- *Bridge Parent* – The physical layer address of the root BSAP-1600 or the BSAP-1600 connected to the root BSAP-1600. (12 hexadecimal digits in the form "xx-xx-xx-xx-xx-xx")
- *Channel Auto Sync* – Allows a Bridge Child to automatically find the operating channel used by its Bridge Parent.
- *Bridge Child* – The physical layer address of other BSAP-1600s for which this BSAP-1600 serves as the bridge parent or the root bridge. Note that the first entry under the list of child nodes is reserved for the root bridge, and can only be configured if the role is set to "Root Bridge." (12 hexadecimal digits in the form "xx-xx-xx-xx-xx-xx")

[Home](#) [Logout](#)

Spanning Tree Protocol

Bridge	<input type="radio"/> Enable <input checked="" type="radio"/> Disable	
Bridge Priority (0-65535)	<input type="text" value="32768"/>	
Bridge Max Age (6-40 sec.)	<input type="text" value="20"/>	
Bridge Hello Time (1-10 sec.)	<input type="text" value="2"/>	
Bridge Forwarding Delay (4-30 sec.)	<input type="text" value="15"/>	

802.11a Interface

Index	Link Path Cost(1-65535)	Link Port Priority(0-255)
Parent Node	<input type="text" value="19"/>	<input type="text" value="0"/>
Child Node2	<input type="text" value="19"/>	<input type="text" value="0"/>
Child Node3	<input type="text" value="19"/>	<input type="text" value="0"/>
Child Node4	<input type="text" value="19"/>	<input type="text" value="0"/>
Child Node5	<input type="text" value="19"/>	<input type="text" value="0"/>
Child Node6	<input type="text" value="19"/>	<input type="text" value="0"/>

802.11g Interface

Index	Link Path Cost(1-65535)	Link Port Priority(0-255)
Parent Node	<input type="text" value="19"/>	<input type="text" value="0"/>
Child Node2	<input type="text" value="19"/>	<input type="text" value="0"/>
Child Node3	<input type="text" value="19"/>	<input type="text" value="0"/>
Child Node4	<input type="text" value="19"/>	<input type="text" value="0"/>
Child Node5	<input type="text" value="19"/>	<input type="text" value="0"/>
Child Node6	<input type="text" value="19"/>	<input type="text" value="0"/>

Ethernet Interface

Link Path Cost(1-65535)	Link Port Priority(0-255)
<input type="text" value="19"/>	<input type="text" value="0"/>

Spanning Tree Protocol – STP uses a distributed algorithm to select a bridging device (STP-compliant switch, bridge or router) that serves as the root of the spanning tree network. It selects a root port on each bridging device (except for the root device) which incurs the lowest path cost when forwarding a packet from that device to the root device. Then it selects a designated bridging device from each LAN which incurs the lowest path cost when forwarding a packet from that LAN to the root device. All ports connected to designated bridging devices are assigned as designated ports. After determining the lowest cost spanning tree, it enables all root ports and designated ports, and disables all other ports. Network packets are therefore only forwarded between root ports and designated ports, eliminating any possible network loops.

Once a stable network topology has been established, all bridges listen for Hello BPDUs (Bridge Protocol Data Units) transmitted from the root bridge. If a bridge does not get a Hello BPDU after a predefined interval (Maximum Age), the bridge assumes that the link to the root bridge is down. This bridge will then

initiate negotiations with other bridges to reconfigure the network to reestablish a valid network topology.

- *Bridge* – Enables/disables STP on the BSAP-1600 or repeater. (Default: Disabled)
- *Bridge Priority* – Used in selecting the root device, root port, and designated port. The device with the highest priority becomes the STP root device. However, if all devices have the same priority, the device with the lowest MAC address will then become the root device. (Note that lower numeric values indicate higher priority.)
 - Range: 0-65535
 - Default: 32768
- *Bridge Max Age* – The maximum time (in seconds) a device can wait without receiving a configuration message before attempting to reconfigure. All device ports (except for designated ports) should receive configuration messages at regular intervals. Any port that ages out STP information (provided in the last configuration message) becomes the designated port for the attached LAN. If it is a root port, a new root port is selected from among the device ports attached to the network. (Range: 6-40 seconds)
 - Default: 20
 - Minimum: The higher of 6 or $[2 \times (\text{Hello Time} + 1)]$.
 - Maximum: The lower of 40 or $[2 \times (\text{Forward Delay} - 1)]$
- *Bridge Hello Time* – Interval (in seconds) at which the root device transmits a configuration message. (Range: 1-10 seconds)
 - Default: 2
 - Minimum: 1
 - Maximum: The lower of 10 or $[(\text{Max. Message Age} / 2) - 1]$
- *Bridge Forwarding Delay* – The maximum time (in seconds) this device waits before changing states (i.e., discarding to learning to forwarding). This delay is required because every device must receive information about topology changes before it starts to forward frames. In addition, each port needs time to listen for conflicting information that would make it return to a discarding state; otherwise, temporary data loops might result. (Range: 4-30 seconds)
 - Default: 15
 - Minimum: The higher of 4 or $[(\text{Max. Message Age} / 2) + 1]$
 - Maximum: 30
- *Link Path Cost* – This parameter is used by the STP to determine the best path between devices. Therefore, lower values should be assigned to ports attached to faster media, and higher values assigned to ports with slower media. (Path cost takes precedence over port priority.)
 - Range: 1-65535
 - Default: Ethernet interface: 19; Wireless interface: 40
- *Link Port Priority* – Defines the priority used for this port in the Spanning Tree Protocol. If the path cost for all ports on a switch are the same, the port with

the highest priority (i.e., lowest value) will be configured as an active link in the spanning tree. This makes a port with higher priority less likely to be blocked if the Spanning Tree Protocol is detecting network loops. Where more than one port is assigned the highest priority, the port with lowest numeric identifier will be enabled.

- Default: 128
- Range: 0-240, in steps of 16

CLI Commands for *WDS Settings* – To set the role of the BSAP-1600 radio interface, use the **bridge role** command from the CLI wireless interface configuration mode. If the role of the radio interface is set to “Bridge” or “Repeater,” the MAC address of the parent node must also be configured using the **bridge-link parent** command. If the role is set to anything other than “Access Point,” then you should also configure the MAC addresses of the child nodes using the **bridge-link child** command. To view the current bridge link settings, use the **show bridge link** command.

```

Enterprise AP(if-wireless a)#bridge role bridge           6-79
Enterprise AP(if-wireless a)#bridge channel-auto-sync enable 6-80
Enterprise AP(if-wireless a)#bridge-link child 2
  00-08-3e-84-bc-6d                                     6-81
Enterprise AP(if-wireless a)#bridge-link child 3
  00-08-3e-85-13-f2
Enterprise AP(if-wireless a)#bridge-link child 4
  00-08-3e-84-79-31
Enterprise AP(if-wireless a)#bridge-link parent
  00-08-2d-69-3a-51                                   6-80
Enterprise AP(if-wireless a)#exit
Enterprise AP#show bridge link wireless a               6-83

Interface Wireless A WDS Information
=====
AP Role:      Bridge
Channel Auto Sync:  Enable
Parent:      00-08-2d-69-3a-51
Child:
  Child 2:   00-08-3e-84-bc-6d
  Child 3:   00-08-3e-85-13-f2
  Child 4:   00-08-3e-84-79-31
  Child 5:   00-00-00-00-00-00
  Child 6:   00-00-00-00-00-00
STAs:
  No WDS Stations.
Enterprise AP#

```

CLI Commands for *STP Settings* – If the role of a radio interface is set to Repeater, Bridge or Root Bridge, STP can be enabled on the BSAP-1600 to maintain a valid network topology. To globally enable STP, use the **bridge stp enable** command from the CLI configuration mode. Then configure the other global STP parameters for the bridge. The path cost and priority for each bridge link can be set using the **bridge-link path-cost** and **bridge-link port-priority** command from the Wireless Interface configuration mode. The path cost and priority can also be set for the Ethernet port from the Ethernet Interface configuration mode. To view the current STP settings, use the **show bridge stp** command.

```

Enterprise AP(config)#bridge stp enable                               6-104
Enterprise AP(config)#bridge stp forwarding-delay 2500             6-105
Enterprise AP(config)#bridge stp hello-time 500                   6-106
Enterprise AP(config)#bridge stp max-age 4000                     6-107
Enterprise AP(config)#bridge stp priority 40000                   6-108
Enterprise AP(config)#interface wireless a
Enterprise AP(if-wireless a)#bridge-link path-cost 2 40           6-109
Enterprise AP(if-wireless a)#bridge-link port-priority 2 64       6-110
Enterprise AP(if-wireless a)#exit
Enterprise AP#show bridge stp                                     6-111

Bridge MAC                : 00:30:F1:F0:9A:9C
Status                    : Disabled
priority                  : 32768
designated-root            : priority = 0, MAC = 00:00:00:00:00:00
root-path-cost            : 0
root-Port-no              : 0
Hold Time                 :      0 Seconds
Hello Time                :      0 Seconds
Maximum Age               :      0 Seconds
Forward Delay             :      0 Seconds
bridge Hello Time        :      2 Seconds
bridge Maximum Age       :     20 Seconds
bridge Forward Delay     :      5 Seconds
time-since-top-change    : 3168 Seconds
topology-change-count    : 0
Enterprise AP#

```

AP Management

The Web, Telnet, and SNMP management interfaces are enabled and open to all IP addresses by default. To provide more security for management access to the BSAP-1600, specific interfaces can be disabled and management restricted to a single IP address or a limited range of IP addresses.

Once you specify an IP address or range of addresses, access to management interfaces is restricted to the specified addresses. If anyone tries to access a management interface from an unauthorized address, the BSAP-1600 will reject the connection.

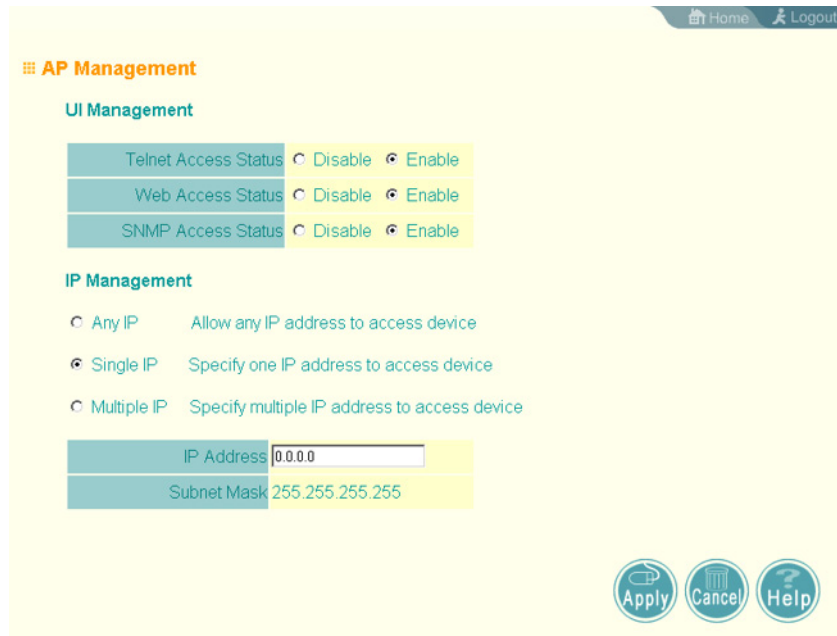

UI Management – Enables or disables management access through Telnet, the Web (HTTP), or SNMP interfaces. (Default: Enabled)

Note: Secure Web (HTTPS) connections are not affected by the UI Management or IP Management settings.

IP Management – Restricts management access to Telnet, Web, and SNMP interfaces to specified IP addresses. (Default: Any IP)

- Any IP: Indicates that any IP address is allowed management access.
- Single IP: Specifies a single IP address that is allowed management access.
- Multiple IP: Specifies an address range as defined by the entered IP address and subnet mask. For example, IP address 192.168.1.0 and subnet mask 255.255.255.0, defines all IP addresses from 192.168.1.1 to 192.168.1.254.

CLI Commands for AP Management features.

```
Enterprise AP(config)#apmgmtip multiple 192.168.1.50 255.255.255.0 6-21
Enterprise AP(config)#apmgmtui SNMP enable 6-22
```

Administration

Changing the Password

Management access to the web and CLI interface on the BSAP-1600 is controlled through a single user name and password. You can also gain additional access security by using control filters (“Filter Control” on page 6-14).

To protect access to the management interface, you need to configure an Administrator’s user name and password as soon as possible. If the user name and password are not configured, then anyone having access to the BSAP-1600 may be able to compromise BSAP-1600 and network security. Once a new

Administrator has been configured, you can delete the default “admin” user name from the system.

Note: Pressing the Reset button on the back of the BSAP-1600 for more than five seconds resets the user name and password to the factory defaults. For this reason, we recommend that you protect the BSAP-1600 from physical access by unauthorized persons.

Username – The name of the user. The default name is “admin.” (Length: 3-16 characters, case sensitive)

New Password – The password for management access. (Length: 3-16 characters, case sensitive)

Confirm New Password – Enter the password again for verification.

CLI Commands for the *Administrator’s User Name and Password* – Use the **username** and **password** commands from the CLI configuration mode.

```
Enterprise AP(config)#username bob           6-15
Enterprise AP(config)#password admin        6-15
Enterprise AP#
```

Setting the Timeout Interval

You can set the timeout interval for web access to the BSAP-1600, after which the user will have to re-enter the username and password.

Session Timeout for WEB – Sets the time limit for an idle web interface session. (Range: 0-1800 seconds; Default: 300 seconds; 0 is disabled)

CLI Command for the Web Session Timeout – Use the **ip http session-timeout** command from the CLI configuration mode.

```
Enterprise AP(config)#ip http session-timeout 0   6-18
Enterprise AP(config)#
```

Upgrading Firmware

You can upgrade new BSAP-1600 software from a local file on the management workstation, or from an FTP or TFTP server. New software releases will be posed on Bluesocket’s support site at www.bluesocket.com.

After upgrading new software, you must reboot the BSAP-1600 to implement the new code. Until a reboot occurs, the BSAP-1600 will continue to run the software it was using before the upgrade started. Also note that new software that is incompatible with the current configuration automatically restores the BSAP-1600 to the factory default settings when first activated after a reboot.

The screenshot shows a web interface for firmware upgrade. At the top right, there are links for 'Home' and 'Logout'. The main heading is 'Firmware Upgrade'. Below this, a box displays 'Current version v4.3.2.0b01'. The interface is divided into two main sections: 'Local' and 'Remote'.
In the 'Local' section, there is a text input field for 'New firmware file' followed by a 'Browse...' button. Below this is a 'Start Upgrade' button.
The 'Remote' section has radio buttons for 'FTP' and 'TFTP', with 'TFTP' selected. Below these are two text input fields: 'New firmware file' and 'IP Address'. A 'Start Upgrade' button is positioned below these fields.
A status message in the center reads: 'It may take several minutes to upgrade the firmware please wait...'.
At the bottom of the form, there are two rows of buttons: 'Restore Factory Settings' with a 'Restore' sub-button, and 'Reboot Access Point' with a 'Reboot' sub-button.
At the bottom right corner, there are three circular icons: 'Apply', 'Cancel', and 'Help'.

Before upgrading new software, verify that the BSAP-1600 is connected to the network and has been configured with a compatible IP address and subnet mask. If you need to download from an FTP or TFTP server, take the following additional steps:

- Obtain the IP address of the FTP or TFTP server where the BSAP-1600 software is stored.
- If upgrading from an FTP server, be sure that you have an account configured on the server with a user name and password.
- If VLANs are configured on the BSAP-1600, determine the VLAN ID with which the FTP or TFTP server is associated, and then configure the management station, or the network port to which it is attached, with the same VLAN ID. If you are managing the BSAP-1600 from a wireless client, the VLAN ID for the wireless client must be configured on a RADIUS server.

Current version – Version number of runtime code.

Firmware Upgrade Local – Downloads an operation code image file from the web management station to the BSAP-1600 using HTTP. Use the Browse button to

locate the image file locally on the management station and click Start Upgrade to proceed.

- **New firmware file:** Specifies the name of the code file on the server. The new firmware file name should not contain slashes (\ or /), the leading letter of the file name should not be a period (.), and the maximum length for file names is 32 characters for files on the BSAP-1600. (Valid characters: A-Z, a-z, 0-9, ".", "-", "_")

Firmware Upgrade Remote – Downloads an operation code image file from a specified remote FTP or TFTP server. After filling in the following fields, click Start Upgrade to proceed.

- **New firmware file:** Specifies the name of the code file on the server. The new firmware file name should not contain slashes (\ or /), the leading letter of the file name should not be a period (.), and the maximum length for file names on the FTP/TFTP server is 255 characters or 32 characters for files on the BSAP-1600. (Valid characters: A-Z, a-z, 0-9, ".", "-", "_")
- **IP Address:** IP address or host name of FTP or TFTP server.
- **Username:** The user ID used for login on an FTP server.
- **Password:** The password used for login on an FTP server.

Configuration File Backup/Restore – Uploads the current BSAP-1600 configuration file to a specified remote FTP or TFTP server. A configuration file can also be downloaded to the BSAP-1600 to restore a specific configuration.

- **Export/Import:** Select Export to upload a file to an FTP/TFTP server. Select Import to download a file from an FTP/TFTP server.
- **Config file:** Specifies the name of the configuration file, which must always be "syscfg." A path on the server can be specified using "/" in the name, providing the path already exists; for example, "myfolder/syscfg." Other than to indicate a path, the file name must not contain any slashes (\ or /), the leading letter cannot be a period (.), and the maximum length for file names on the FTP/TFTP server is 255 characters. (Valid characters: A-Z, a-z, 0-9, ".", "-", "_")
- **IP Address:** IP address or host name of FTP or TFTP server.
- **Username:** The user ID used for login on an FTP server.
- **Password:** The password used for login on an FTP server.

Restore Factory Settings – Click the Restore button to reset the configuration settings for the BSAP-1600 to the factory defaults and reboot the system. Note that all user configured information will be lost. You will have to re-enter the default user name (admin) to re-gain management access to this device.

Reboot BSAP-1600 – Click the Reset button to reboot the system.

Note: If you have upgraded system software, then you must reboot the BSAP-1600 to implement the new operation code. New software that is incompatible with the current configuration automatically restores the BSAP-1600 to default values when first activated after a reboot.

Upon uploading a new configuration file you will be prompted to either restore factory settings, or reboot the BSAP-1600.

Suggestion: Using new default configuration settings lets system be more efficient, but system will lose current settings.

Goto Previous Page	GotoPrevious
Restore Factory Settings	Restore
Reboot Access Point	Reboot

CLI Commands for *Downloading Software from a TFTP Server* – Use the **copy tftp file** command from the Exec mode and then specify the file type, name, and IP address of the TFTP server. When the download is complete, the **dir** command can be used to check that the new file is present in the BSAP-1600 file system. To run the new software, use the **reset board** command to reboot the BSAP-1600.

```

Enterprise AP#copy tftp file                                     6-57
1. Application image
2. Config file
3. Boot block image
Select the type of download<1,2,3>: [1]:1
TFTP Source file name:img.bin
TFTP Server IP:192.168.1.19

Enterprise AP#dir                                             6-59
File Name              Type   File Size
-----
dflt-img.bin           2      1319939
img.bin                 2      1629577
syscfg                  5       17776
syscfg_bak              5       17776

                262144 byte(s) available

Enterprise AP#reset board                                     6-10
Reboot system now? <y/n>: y
    
```

System Log

The BSAP-1600 can be configured to send event and error messages to a System Log Server. The system clock can also be synchronized with a time server, so that all the messages sent to the Syslog server are stamped with the correct time and date.

Enabling System Logging

The BSAP-1600 supports a logging process that can control error messages saved to memory or sent to a Syslog server. The logged messages serve as a valuable tool for isolating BSAP-1600 and network problems.

System Log Setup – Enables the logging of error messages. (Default: Disable)

Server (1-4) – Enables the sending of log messages to a Syslog server host. Up to four Syslog servers are supported on the BSAP-1600. (Default: Disable)

Server Name/IP – The IP address or name of a Syslog server. (Default: 0.0.0.0)

UDP Port – The UDP port used by a Syslog server. (Range: 514 or 11024-65535; Default: 514)

Logging Console – Enables the logging of error messages to the console. (Default: Disable)

Logging Level – Sets the minimum severity level for event logging. (Default: Informational)

The system allows you to limit the messages that are logged by specifying a minimum severity level. The following table lists the error message levels from the most severe (Emergency) to least severe (Debug). The message levels that are logged include the specified minimum level up to the Emergency level.

Table 6-3: System Logging Error Messages

Error Level	Description
Emergency	System unusable

Table 6-3: System Logging Error Messages

Alerts	Immediate action needed
Critical	Critical conditions (e.g., memory allocation, or free memory error - resource exhausted)
Error	Error conditions (e.g., invalid input, default used)
Warning	Warning conditions (e.g., return false, unexpected return)
Notice	Normal but significant condition, such as cold start
Informational	Informational messages only
Debug	Debugging messages

Note: The BSAP-1600 error log can be viewed using the Event Logs window in the Status section (Event Logs). The Event Logs window displays the last 128 messages logged in chronological order, from the newest to the oldest. Log messages saved in the BSAP-1600's memory are erased when the device is rebooted.

Logging Facility Type – Sets the facility type for remote logging of syslog messages. The command specifies the facility type tag sent in syslog messages. This type has no effect on the kind of messages reported by the switch. However, it may be used by the syslog server to sort messages or to store messages in the corresponding database. (Range: 16-23; Default: 16)

CLI Commands for *System Logging* – To enable logging on the BSAP-1600, use the **logging on** command from the global configuration mode. The **logging level** command sets the minimum level of message to log. Use the **logging console** command to enable logging to the console. Use the **logging host** command to specify up to four Syslog servers. The CLI also allows the **logging facility-type** command to set the facility-type number to use on the Syslog server. To view the current logging settings, use the **show logging** command.

```
Enterprise AP(config)#logging on                6-30
Enterprise AP(config)#logging level alert       6-31
Enterprise AP(config)#logging console          6-31
Enterprise AP(config)#logging host 1 IP 10.1.0.3 514 6-30
Enterprise AP(config)#logging host 1 Port 514  6-30
Enterprise AP(config)#logging facility-type 19 6-32
Enterprise AP(config)#exit
Enterprise AP#show logging                     6-33
```

```
Logging Information
=====
Syslog State           : Enabled
Logging Console State  : Enabled
Logging Level          : Alert
Logging Facility Type  : 19
Servers
  1: 10.1.0.3, UDP Port: 514, State: Enabled
  2: 0.0.0.0, UDP Port: 514, State: Disabled
  3: 0.0.0.0, UDP Port: 514, State: Disabled
  4: 0.0.0.0, UDP Port: 514, State: Disabled
=====
Enterprise AP#
```

Configuring SNTP

Simple Network Time Protocol (SNTP) allows the BSAP-1600 to set its internal clock based on periodic updates from a time server (SNTP or NTP). Maintaining

an accurate time on the BSAP-1600 enables the system log to record meaningful dates and times for event entries. If the clock is not set, the BSAP-1600 will only record the time from the factory default set at the last bootup.

The BSAP-1600 acts as an SNTP client, periodically sending time synchronization requests to specific time servers. You can configure up to two time server IP addresses. The BSAP-1600 will attempt to poll each server in the configured sequence.

SNTP Server – Configures the BSAP-1600 to operate as an SNTP client. When enabled, at least one time server IP address must be specified.

- **Primary Server:** The IP address of an SNTP or NTP time server that the BSAP-1600 attempts to poll for a time update.
- **Secondary Server:** The IP address of a secondary SNTP or NTP time server. The BSAP-1600 first attempts to update the time from the primary server; if this fails it attempts an update from the secondary server.

Note: The BSAP-1600 also allows you to disable SNTP and set the system clock manually.

Set Time Zone – SNTP uses Coordinated Universal Time (or UTC, formerly Greenwich Mean Time, or GMT) based on the time at the Earth's prime meridian, zero degrees longitude. To display a time corresponding to your local time, you must indicate the number of hours your time zone is located before (east) or after (west) UTC.

Enable Daylight Saving – The BSAP-1600 provides a way to automatically adjust the system clock for Daylight Savings Time changes. To use this feature you must define the month and date to begin and to end the change from standard time. During this period the system clock is set back by one hour.

CLI Commands for SNTP – To enable SNTP support on the BSAP-1600, from the global configuration mode specify SNTP server IP addresses using the **sntp-server ip** command, then use the **sntp-server enable** command to enable the service. Use the **sntp-server timezone** command to set the time zone for your location, and the **sntp-server daylight-saving** command to set daylight savings. To view the current SNTP settings, use the **show sntp** command.

```

Enterprise AP(config)#ntp-server ip 1 10.1.0.19           6-35
Enterprise AP(config)#ntp-server enable                 6-35
Enterprise AP(config)#ntp-server timezone +8           6-37
Enterprise AP(config)#ntp-server daylight-saving       6-37
Enter Daylight saving from which month<1-12>: 3
and which day<1-31>: 31
Enter Daylight saving end to which month<1-12>: 10
and which day<1-31>: 31
Enterprise AP(config)#exit
Enterprise AP#show ntp                                 6-38

SNTP Information
=====
Service State      : Enabled
SNTP (server 1) IP : 10.1.10.19
SNTP (server 2) IP : 192.43.244.18
Current Time       : 19 : 35, Oct 10th, 2003
Time Zone          : +8 (TAIPEI, BEIJING)
Daylight Saving    : Enabled, from Mar, 31st to Oct, 31st
=====
Enterprise AP#

```

CLI Commands for the *System Clock* – The following example shows how to manually set the system time when SNTP server support is disabled on the BSAP-1600.

```

Enterprise AP(config)#no ntp-server enable             6-35
Enterprise AP(config)#ntp-server date-time            6-36
Enter Year<1970-2100>: 2003
Enter Month<1-12>: 10
Enter Day<1-31>: 10
Enter Hour<0-23>: 18
Enter Min<0-59>: 35
Enterprise AP(config)#

```

RSSI

The RSSI value displayed on the RSSI page represents a signal to noise ratio. A value of 30 would indicate that the power of the received signal is 30 dBm above the signal noise threshold. This value can be used to align antennas (“Align Antennas” on page 2-7) and monitor the quality of the received signal for bridge links. An RSSI value of about 30 or more indicates a strong enough signal to support the maximum data rate of 54 Mbps. Below a value of 30, the supported data rate would drop to lower rates. A value of 15 or less indicates that the signal is weak and the antennas may require realignment.

The RSSI controls allow the external connector to be disabled and the receive signal for each WDS port displayed.

RSSI – The RSSI value for a selected port can be displayed and a representative voltage output can be enabled.

- Output Activate: Enables or disables the RSSI voltage output on the external RSSI connector. (Default: Enabled)
- Port Number: Selects a specific WDS port for which to set the maximum RSSI output voltage level. Ports 1-6 are available for a Master BSAP-1600, only port 1 for a Node BSAP-1600. (Default: 1)

Output Value: The maximum RSSI voltage level for the current selected WDS port. A value of zero indicates that there is no received signal or that the WDS port is disabled.

Distance – This value is used to adjust timeout values to take into account transmit delays due to link distances in the bridge link network. For a point-to-point link, specify the approximate distance between the two bridges. For a point-to-multipoint network, specify the distance of the Node BSAP-1600 farthest from the Master BSAP-1600

- Mode: Indicates if the 802.11a radio is operating in normal or Turbo mode. (see See “Radio Settings A (802.11a)” on page 44.)
- Distance: The approximate distance between antennas in a bridge link.

There are currently no equivalent CLI commands for the RSSI controls.

SNMP

Simple Network Management Protocol (SNMP) is a communication protocol designed specifically for managing devices on a network. Equipment commonly managed with SNMP includes switches, routers and host computers. SNMP is typically used to configure these devices for proper operation in a network

environment, as well as to monitor them to evaluate performance or detect potential problems.

Managed devices supporting SNMP contain software, which runs locally on the device and is referred to as an agent. A defined set of variables, known as managed objects, is maintained by the SNMP agent and used to manage the device. These objects are defined in a Management Information Base (MIB) that provides a standard presentation of the information controlled by the agent. SNMP defines both the format of the MIB specifications and the protocol used to access this information over the network.

The BSAP-1600 includes an onboard agent that supports SNMP versions 1, 2c, and 3 clients. This agent continuously monitors the status of the BSAP-1600, as well as the traffic passing to and from wireless clients. A network management station can access this information using SNMP management software that is compliant with MIB II. To implement SNMP management, the BSAP-1600 must first have an IP address and subnet mask, configured either manually or dynamically. Access to the onboard agent using SNMP v1 and v2c is controlled by community strings. To communicate with the BSAP-1600, the management station must first submit a valid community string for authentication.

Access to the BSAP-1600 using SNMP v3 provides additional security features that cover message integrity, authentication, and encryption; as well as controlling notifications that are sent to specified user targets.

Configuring SNMP and Trap Message Parameters

The BSAP-1600 SNMP agent must be enabled to function (for versions 1, 2c, and 3 clients). Management access using SNMP v1 and v2c also requires community strings to be configured for authentication. Trap notifications can be enabled and sent to up to four management stations.

SNMP : Disable Enable

Location	<input type="text"/>
Contact	<input type="text" value="Contact"/>
Community Name (Read Only)	<input type="text" value="public"/>
Community Name (Read/Write)	<input type="text" value="private"/>
Trap Destination 1	<input checked="" type="radio"/> Disable <input type="radio"/> Enable
Trap Destination IP Address	<input type="text" value="0.0.0.0"/>
Trap Destination Community Name	<input type="text" value="public"/>
Trap Destination 2	<input checked="" type="radio"/> Disable <input type="radio"/> Enable
Trap Destination IP Address	<input type="text"/>
Trap Destination Community Name	<input type="text"/>
Trap Destination 3	<input checked="" type="radio"/> Disable <input type="radio"/> Enable
Trap Destination IP Address	<input type="text"/>
Trap Destination Community Name	<input type="text"/>
Trap Destination 4	<input checked="" type="radio"/> Disable <input type="radio"/> Enable
Trap Destination IP Address	<input type="text"/>
Trap Destination Community Name	<input type="text"/>
Engine ID	<input type="text" value="80.00.07.e5.80.00.00.fdb.e3c.26.70.e3"/>

SNMP – Enables or disables SNMP management access and also enables the BSAP-1600 to send SNMP traps (notifications). (Default: Disable)

Location – A text string that describes the system location. (Maximum length: 255 characters)

Contact – A text string that describes the system contact. (Maximum length: 255 characters)

Community Name (Read Only) – Defines the SNMP community access string that has read-only access. Authorized management stations are only able to retrieve MIB objects. (Maximum length: 23 characters, case sensitive; Default: public)

Community Name (Read/Write) – Defines the SNMP community access string that has read/write access. Authorized management stations are able to both retrieve and modify MIB objects. (Maximum length: 23 characters, case sensitive; Default: private)

Trap Destination (1 to 4) – Enables recipients (up to four) of SNMP notifications.

- *Trap Destination IP Address* – Specifies the recipient of SNMP notifications. Enter the IP address or the host name. (Host Name: 1 to 63 characters, case sensitive)
- *Trap Destination Community Name* – The community string sent with the notification operation. (Maximum length: 23 characters, case sensitive; Default: public)

Engine ID – Sets the engine identifier for the SNMPv3 agent that resides on the BSAP-1600. This engine protects against message replay, delay, and redirection.

The engine ID is also used in combination with user passwords to generate the security keys for authenticating and encrypting SNMPv3 packets. A default engine ID is automatically generated that is unique to the BSAP-1600. (Range: 10 to 64 hexadecimal characters)

Note: If the local engine ID is deleted or changed, all SNMP users will be cleared. All existing users will need to be re-configured. If you want to change the default engine ID, change it first before configuring other SNMP v3 parameters.

Trap Configuration – Allows selection of specific SNMP notifications to send. The following items are available:

- sysSystemUp - The BSAP-1600 is up and running.
- sysSystemDown - The BSAP-1600 is about to shutdown and reboot.
- sysRadiusServerChanged - The BSAP-1600 has changed from the primary RADIUS server to the secondary, or from the secondary to the primary.
- sysConfigFileVersionChanged - The BSAP-1600's configuration file has been changed.
- dot11StationAssociation - A client station has successfully associated with the BSAP-1600.
- dot11StationReAssociation - A client station has successfully re-associated with the BSAP-1600.
- dot11StationAuthentication - A client station has been successfully authenticated.
- dot11StationRequestFail - A client station has failed association, re-association, or authentication.
- dot11InterfaceBFail - The 802.11b interface has failed.
- dot11InterfaceAFail - The 802.11a or 802.11g interface has failed.

- dot1xMacAddrAuthSuccess - A client station has successfully authenticated its MAC address with the RADIUS server.
- dot1xMacAddrAuthFail - A client station has failed MAC address authentication with the RADIUS server.
- dot1xAuthNotInitiated - A client station did not initiate 802.1x authentication.
- dot1xAuthSuccess - A 802.1x client station has been successfully authenticated by the RADIUS server.
- dot1xAuthFail - A 802.1x client station has failed RADIUS authentication.
- dot1xSuppAuthenticated - A supplicant station has been successfully authenticated by the RADIUS server
- localMacAddrAuthSuccess - A client station has successfully authenticated its MAC address with the local database on the BSAP-1600.
- localMacAddrAuthFail - A client station has failed authentication with the local MAC address database on the BSAP-1600.
- iappStationRoamedFrom - A client station has roamed from another BSAP-1600 (identified by its IP address).
- iappStationRoamedTo - A client station has roamed to another BSAP-1600 (identified by its IP address).
- iappContextDataSent - A client station's Context Data has been sent to another BSAP-1600 with which the station has associated.
- snmpServerFail - The BSAP-1600 has failed to set the time from the configured SNMP server.
- wirelessExternalAntenna - An external antenna has been enabled.
- dot11WirelessStationDeauthenticate - A client station has de-authenticated from the network.
- dot11StationDisassociate - A client station no longer associates with the network.
- dot11StationAuthenticateFail - A client station has tried and failed to authenticate to the network.
- *Enable All Traps* - Click the button to enable all the available traps.
- *Disable All Traps* - Click the button to disable all the available traps.

CLI Commands for *SNMP and Trap Configuration* – Use the **snmp-server enable server** command from the global configuration mode to enable the SNMP agent. Use the **snmp-server location** and **snmp-server contact** commands to indicate the physical location of the BSAP-1600 and define a system contact. To set the read-only and read/write community names, use the **snmp-server community** command. Use the **snmp-server host** command to define a trap receiver host and the **snmp-server trap** command to enable or disable specific traps.

Enterprise AP(config)#snmp-server enable server	6-43
Enterprise AP(config)#snmp-server community alpha rw	6-42
Enterprise AP(config)#snmp-server community beta ro	
Enterprise AP(config)#snmp-server location WC-19	6-43
Enterprise AP(config)#snmp-server contact Paul	6-42
Enterprise AP(config)#snmp-server host 192.168.1.9 alpha	6-44
Enterprise AP(config)#snmp-server trap dot11StationAssociation	6-45
Enterprise AP(config)#	

To view the current SNMP settings, use the **show snmp** command.

```

Enterprise AP#show snmp
Enterprise AP#show snmp
SNMP Information
=====
Service State           : Enable
Community (ro)         : *****
Community (rw)         : *****
Location                : WC-19
Contact                 : Paul

EngineId                : 80:00:07:e5:80:00:00:2e:62:00:00:00:18
EngineBoots:1

Trap Destinations:
1:      192.168.1.9, Community: *****, State: Enabled
2:      0.0.0.0, Community: *****, State: Disabled
3:      0.0.0.0, Community: *****, State: Disabled
4:      0.0.0.0, Community: *****, State: Disabled

dot11InterfaceAGFail   Enabled
dot11StationAssociation Enabled
dot11StationReAssociation Enabled
dot1xAuthFail          Enabled
dot1xAuthSuccess       Enabled
dot1xMacAddrAuthSuccess Enabled
iappStationRoamedFrom  Enabled
localMacAddrAuthFail   Enabled
iappContextDataSent    Enabled
wirelessExternalAntenna Enabled
dot11InterfaceGFail    Enabled
pppLogonFail           Enabled
configFileVersionChanged Enabled
systemDown             Enabled

dot11InterfaceBFail    Enabled
dot11StationAuthentication Enabled
dot11StationRequestFail Enabled
dot1xAuthNotInitiated  Enabled
dot1xMacAddrAuthFail   Enabled
iappContextDataSent    Enabled
iappStationRoamedTo    Enabled
localMacAddrAuthSuccess Enabled
dot1XSuppAuthenticated Enabled
dot11InterfaceAFail    Enabled

sntpServerFail         Enabled
radiusServerChanged    Enabled
systemUp               Enabled
=====
Enterprise AP#
    
```

Configuring SNMPv3 Users

The BSAP-1600 allows up to 10 SNMP v3 users to be configured. Each user must be defined by a unique name, assigned to one of three pre-defined security groups, and configured with specific authentication and encryption settings.

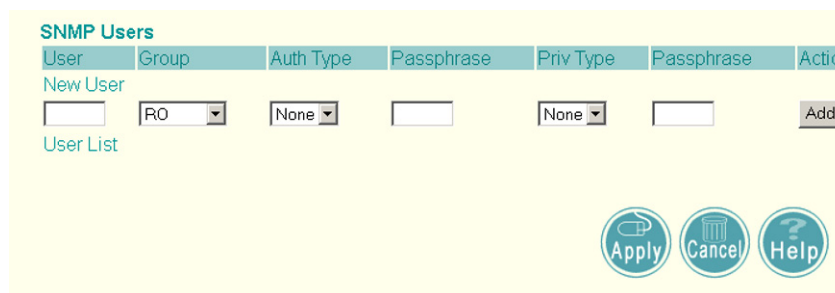

User – The SNMPv3 user name. (32 characters maximum)

Group – The SNMPv3 group name. (Options: RO, RWAuth, or RWPriv; Default: RO)

- RO – Read-only access.
- RWAuth – Read/write access with user authentication.

- RWPriv – Read/write access with both user authentication and data encryption.

Auth Type – The authentication type used for the SNMP user; either MD5 or none. When MD5 is selected, enter a password in the corresponding Passphrase field.

Priv Type – The data encryption type used for the SNMP user; either DES or none. When DES is selected, enter a key in the corresponding Passphrase field.

Passphrase – The password or key associated with the authentication and privacy settings. A minimum of eight plain text characters is required.

Action – Click the Add button to add a new user to the list. Click the edit button to change details of an existing user. Click the Del button to remove a user from the list.

Note: Users must be assigned to groups that have the same security levels. For example, a user who has “Auth Type” and “Priv Type” configured to MD5 and DES respectively (that it uses both authentication and data encryption) must be assigned to the RWPriv group. If this same user were instead assigned to the read-only (RO) group, the user would not be able to access the database.

CLI Commands for *Configuring SNMPv3 Users* – Use the **snmp-server engine-id** command to define the SNMP v3 engine before assigning users to groups. Use the **snmp-server user** command to assign users to one of the three groups and set the appropriate authentication and encryption types to be used. To view the current SNMP v3 engine ID, use the **show snmp** command. To view SNMP users and group settings, use the **show snmp users** or **show snmp group-assignments** commands.

```

Enterprise AP(config)#snmp-server engine-id 1a:2b:3c:4d:00:ff      6-46
Enterprise AP(config)#snmp-server user                          6-47
User Name<1-32> :chris
Group Name<1-32> :RWPriv
Authtype(md5,<cr>none) :md5
Passphrase<8-32>:a good secret
Privacy(des,<cr>none) :des
Passphrase<8-32>:a very good secret
Enterprise AP(config)#exit
Enterprise AP#show snmp users                                  6-52

=====
UserName      :chris
GroupName    :RWPriv
AuthType     :MD5
Passphrase   :*****
PrivType     :DES
Passphrase   :*****
=====
Enterprise AP#show snmp group-assignments                    6-52

GroupName    :RWPriv
UserName     :chris
Enterprise AP#

```

Configuring SNMPv3 Trap Filters

SNMP v3 users can be configured to receive notification messages from the BSAP-1600. An SNMP Target ID is created that specifies the SNMP v3 user, IP

address, and UDP port. A user-defined notification filter can be created so that specific notifications can be prevented from being sent to particular targets.

The BSAP-1600 allows up to 10 notification filters to be created. Each filter can be defined by up to 20 MIB subtree ID entries.

To configure a new notification filter, click the New button. A new page opens to configure the filter (see below). To edit an existing filter, select the radio button next to the entry in the table and then click the Edit button. To delete a filter, select the radio button next to the entry in the table and then click the Delete button.

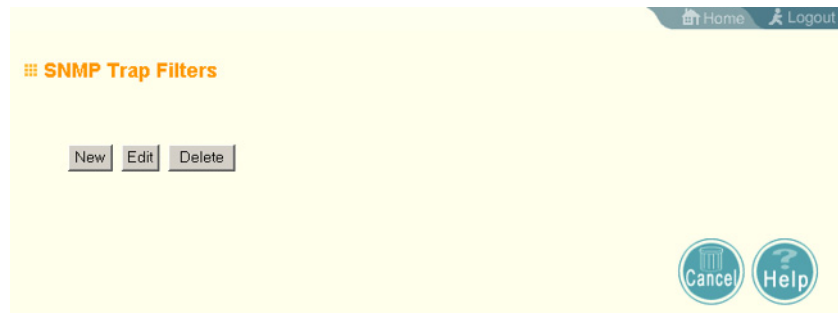

When you click on the New button in the SNMP Trap Filters page, a new page opens where the filter parameters are configured. Define a filter name and subtree ID to be filtered. Select the filter type, include or exclude, from the drop-down list. Click Apply to create the filter.

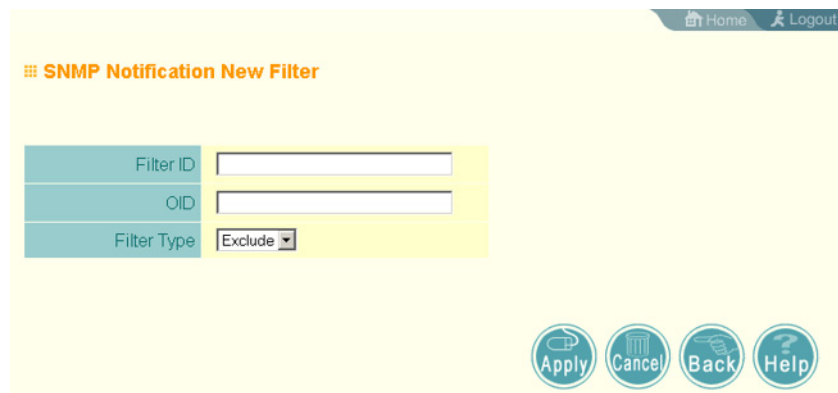

To add more subtree IDs to the filter, return to the SNMP Trap Filters page and click the Edit button. In the Edit page, click the New button to access the Add SNMP Notification Subtree page and configure a new subtree ID to be filtered.

Note: Only the New Filter page allows the Filter ID to be configured.

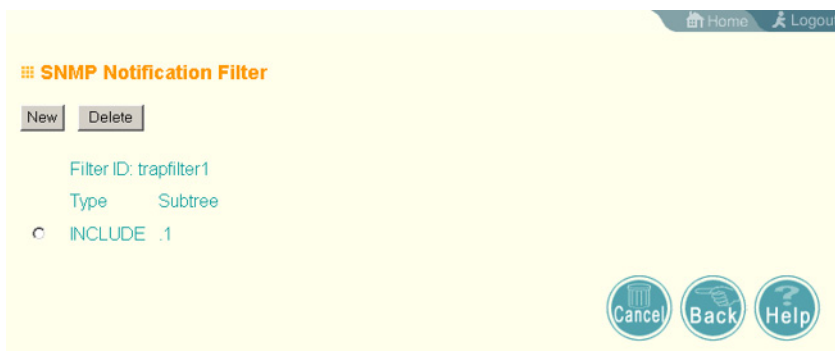

Filter ID – A user-defined name that identifies the filter. (Maximum length: 32 characters)

Subtree OID – Specifies MIB subtree to be filtered. The MIB subtree must be defined in the form “.1.3.6.1” and always start with a “.”.

Filter Type – Indicates if the filter is to “include” or “exclude” the MIB subtree objects from the filter. Note that MIB objects included in the filter are not sent to the receiving target and objects excluded are sent. By default all traps are sent, so you can first use an “include” filter entry for all trap objects. Then use “exclude” entries for the required trap objects to send to the target. Note that the filter entries are applied in the sequence that they are defined.

CLI Commands for *Configuring SNMPv3 Trap Filters* – To create a notification filter, use the **snmp-server filter** command from the CLI configuration mode. Use the command more than once with the same filter ID to build a filter that includes or excludes multiple MIB objects. To view the current SNMP filters, use the **show snmp filter** command from the CLI Exec mode.

```

Enterprise AP(config)#snmp-server filter trapfilter
  include .1                                     6-50
Enterprise AP(config)#snmp-server filter trapfilter
  exclude .1.3.6.1.2.1.2.2.1.1.23
Enterprise AP(config)#exit
Enterprise AP#show snmp filter                  6-53

Filter: trapfilter
  Type: include
  Subtree: iso

      Type: exclude
      Subtree: iso.3.6.1.2.1.2.2.1.1.23
=====
Enterprise AP#

```

Configuring SNMPv3 Targets

An SNMP v3 notification Target ID is specified by the SNMP v3 user, IP address, and UDP port. A user-defined filter can also be assigned to specific targets to limit the notifications received to specific MIB objects. (Note that the filter must first be configured. Configuring SNMPv3 Trap Filters)

To configure a new notification receiver target, click the New button. A new page opens to configure the settings (see below). To edit an existing target, select the radio button next to the entry in the table and then click the Edit button. To delete

targets, select the radio button next to the entry in the table and then click the Delete button.

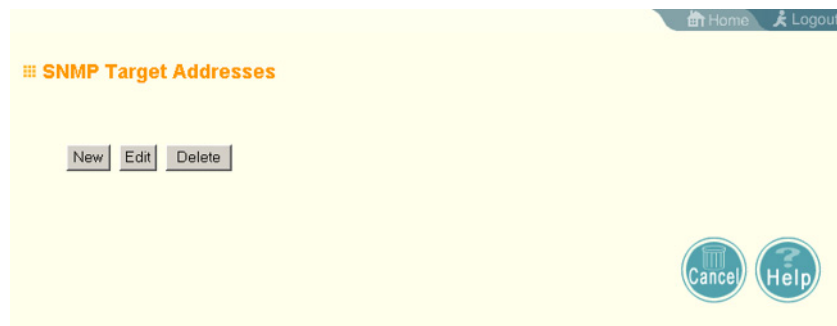

When you click on the New or Edit button in the SNMP Targets page, a new page opens where the target parameters are configured. Define the parameters and select a filter, if required. Note that the SNMP v3 user name must first be defined (Configuring SNMPv3 Users). Click Apply.

Note: The Target ID cannot be changed in the Edit Target page. Only the New Target page allows the Target ID to be configured.

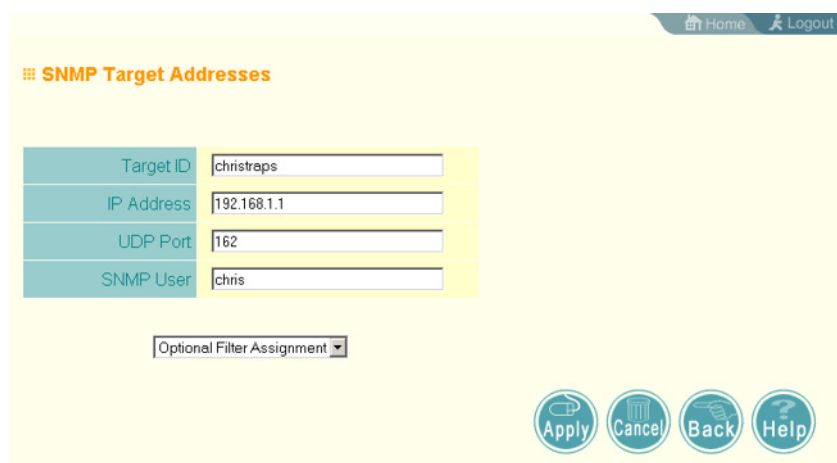

Target ID – A user-defined name that identifies a receiver of notifications. The BSAP-1600 supports up to 10 target IDs. (Maximum length: 32 characters)

IP Address – Specifies the IP address of the receiving management station.

UDP Port – The UDP port that is used on the receiving management station for notification messages.

SNMP User – The defined SNMP v3 user that is to receive notification messages.

Assigned Filter – The name of a user-defined notification filter that is applied to the target.

CLI Commands for *Configuring SNMPv3 Targets* – To create a notification target, use the **snmp-server targets** command from the CLI configuration mode. To assign a filter to a target, use the **snmp-server filter-assignment** command. To view the

current SNMP targets, use the **show snmp target** command from the CLI Exec mode. To view filter assignment to targets, use the **show snmp filter-assignments** command.

```

Enterprise AP(config)#snmp-server targets mytraps
192.168.1.33 chris 6-49
Enterprise AP(config)#snmp-server filter-assignment
mytraps trapfilter 6-51
Enterprise AP(config)#exit
Enterprise AP#show snmp target 6-53

Host ID      : mytraps
User        : chris
IP Address   : 192.168.1.33
UDP Port    : 162
=====
Enterprise AP#show snmp filter-assignments 6-54

                HostID  FilterID
                mytraps trapfilter
Enterprise AP#

```

Radio Interface

The IEEE 802.11a and 802.11g interfaces include configuration options for radio signal characteristics and wireless security features. The configuration options are nearly identical, and are therefore both covered in this section of the manual.

The BSAP-1600 can operate in three modes, IEEE 802.11a only, 802.11b/g only, or a mixed 802.11a/b/g mode. Also note that 802.11g is backward compatible with 802.11b. These interfaces are configured independently under the following web pages:

- Radio Interface A: 802.11a
- Radio Interface G: 802.11b/g

Each radio supports up to four virtual access point (VAP) interfaces numbered 0 to 3. Each VAP functions as a separate access point, and can be configured with its own Service Set Identification (SSID) and security settings. However, most radio signal parameters apply to all four VAP interfaces.

The VAPs function similar to a VLAN, with each VAP mapped to its own VLAN ID. Traffic to specific VAPs can be segregated based on user groups or application traffic. Each VAP can have up to 64 wireless clients, whereby the clients associate with these VAPs the same as they would with a physical access point.

Note: The radio channel settings for the BSAP-1600 are limited by local regulations, which determine the number of channels that are available. Refer to “General Specifications” on page C-1 for additional information on the maximum number channels available.

Radio Settings A (802.11a)

The IEEE 802.11a interface operates within the 5 GHz band, at up to 54 Mbps in normal mode or up to 108 Mbps in Turbo mode.

First configure the radio settings that apply to the individual VAPs (Virtual Access Point) and the common radio settings that apply to the overall system. After you have configured the radio settings, go to the Security page under the 802.a Interface (Security), enable the radio service for any of the VAP interfaces, and then set an SSID to identify the wireless network service provided by each VAP. Remember that only clients with the same SSID can associate with a VAP.

Note: You must first enable VAP interface 0 before the other interfaces can be enabled.

Configuring VAP Radio Settings

To configure VAP radio settings, select the Radio Settings page.

The screenshot displays the configuration interface for 802.11a radio settings. It is organized into several sections:

- 802.11a:** The main category, with a home button in the top right corner.
- Radio Settings:** The current configuration page.
- Individual:**
 - Default VLAN ID (1 ~ 4094):** A table with four rows for VAP 0, VAP 1, VAP 2, and VAP 3. Each row has a text input field containing the value '1'.
 - Closed System:** A table with four rows for VAP 0, VAP 1, VAP 2, and VAP 3. Each row has two radio buttons: 'Disable' (which is selected) and 'Enable'.
 - Authentication Timeout Interval (5-60) : (Mins):** A table with four rows for VAP 0, VAP 1, VAP 2, and VAP 3. Each row has a text input field containing the value '60'.

Association Timeout Interval (5-60) : (Mins)	
VAP 0	30
VAP 1	30
VAP 2	30
VAP 3	30

WPA2 PMKSA Life Time (1~1440) : (Mins)	
VAP 0	720
VAP 1	720
VAP 2	720
VAP 3	720

Default VLAN ID – The VLAN ID assigned to wireless clients associated to the VAP (Virtual Access Point) interface that are not assigned to a specific VLAN by RADIUS server configuration. (Default: 1)

Closed System – When enabled, the VAP interface does not include its SSID in beacon messages. Nor does it respond to probe requests from clients that do not include a fixed SSID. (Default: Disable)

Authentication Timeout Interval – The time within which the client should finish authentication before authentication times out. (Range: 5-60 minutes; Default: 60 minutes)

Association Timeout Interval – The idle time interval (when no frames are sent) after which a client is disassociated from the VAP interface. (Range: 5-60 minutes; Default: 30 minutes)

WPA2 PMKSA Life Time – WPA2 provides fast roaming for authenticated clients by retaining keys and other security settings in a cache for each VAP. In this way, when clients roam back into a VAP they had previously been using, re-authentication is not required. When a WPA2 client is first authenticated, it receives a Pairwise Master Key (PMK) that is used to generate the other keys used for unicast data encryption. This key and other client information form a client Security Association (SA) that the VAP holds in a cache. When the lifetime expires, the security association and keys are deleted from the cache. If the client returns to an access point after the association has been deleted, it will require full re-authentication. (Range: 1-1440 minutes; Default: 720 minutes)

CLI Commands for the *Configuring the VAPs* – From the global configuration mode, enter the **interface wireless a** command to access the 802.11a radio interface. From the 802.11a interface mode, you can access radio settings that apply to all VAP interfaces. To access a specific VAP interface (numbered 0 to 3), use the **vap** command. You can configure a name for each interface using the **description** command. You can also use the **closed-system** command to stop sending the SSID in beacon messages. Set any other VAP parameters and radio setting as required before enabling the VAP interface (with the **no shutdown** command). To view the current 802.11a radio settings for the VAP (Virtual Access

Point) interface, use the **show interface wireless a [0-3]** command as shown on 6-97.

```
Enterprise AP(if-wireless a)#vap 0 6-97
Enterprise AP(if-wireless a: VAP[0])#description RD-AP#3 6-108
Enterprise AP(if-wireless a: VAP[0])#vlan-id 1 6-135
Enterprise AP(if-wireless a: VAP[0])#closed-system 6-109
Enterprise AP(if-wireless a: VAP[0])#authentication-timeout-
interval 30 6-110
Enterprise AP(if-wireless a: VAP[0])#association-timeout-
interval 20 6-110
Enterprise AP(if-wireless a: VAP[0])#max-association 32 6-110
Enterprise AP(if-wireless a: VAP[0])#pmksa-lifetime 900 6-127
Enterprise AP(if-wireless a: VAP[0])#
```

Configuring Rogue AP Detection

To configure Rogue AP detection, select the Radio Settings page, and scroll down to the "Rogue AP" section.

Common:

Rogue AP :

AP Detection	<input checked="" type="radio"/> Disable <input type="radio"/> Enable
AP Scan Interval (30-10080 min.)	<input type="text" value="720"/> (minutes)
AP Scan Duration (100-1000 milli sec.)	<input type="text" value="350"/> (milliseconds)
Scan AP Now	<input checked="" type="radio"/> Disable <input type="radio"/> Enable

Rogue AP – A "rogue AP" is either an access point that is not authorized to participate in the wireless network, or an access point that does not have the correct security configuration. Rogue APs can allow unauthorized access to the network, or fool client stations into mistakenly associating with them and thereby blocking access to network resources.

The BSAP-1600 can be configured to periodically scan all radio channels and find other access points within range. A database of nearby access points is maintained where any rogue APs can be identified. During a scan, Syslog messages (See "System Log " on page 28.) are sent for each access point detected. Rogue access points can be identified by unknown BSSID (MAC address) or SSID configuration.

- AP Detection – Enables the periodic scanning for other access points. (Default: Disable)
- AP Scan Interval – Sets the time between each rogue AP scan. (Range: 30 - 10080 minutes; Default: 720 minutes)
- AP Scan Duration – Sets the length of time for each rogue AP scan. A long scan duration time will detect more access points in the area, but causes more disruption to client access. (Range: 100 -1000 milliseconds; Default: 350 milliseconds)
- Rogue AP Authenticate – Enables or disables RADIUS authentication. Enabling RADIUS Authentication allows the BSAP-1600 to discover rogue access points. With RADIUS authentication enabled, the BSAP-1600 checks the MAC address/ Basic Service Set Identifier (BSSID) of each access point that it finds against a RADIUS server to determine whether the access point is allowed. With RADIUS authentication disabled, the BSAP-1600 can detect its

neighboring access points only; it cannot identify whether the access points are allowed or are rogues. If you enable RADIUS authentication, you must configure a RADIUS server for this BSAP-1600 (RADIUS).

- Scan AP Now – Starts an immediate rogue AP scan on the radio interface. (Default: Disable)

Note: While the BSAP-1600 scans a channel for rogue APs, wireless clients will not be able to connect to the BSAP-1600. Therefore, avoid frequent scanning or scans of a long duration unless there is a reason to believe that more intensive scanning is required to find a rogue AP.

CLI Commands for *Rogue AP Detection* – From the global configuration mode, enter the **interface wireless** command to access the 802.11a or 802.11g radio interface. From the wireless interface mode, use the **rogue-ap enable** command to enable rogue AP detection. Set the duration and interval times with the **rogue-ap duration** and **rogue-ap interval** commands. If required, start an immediate scan using the **rogue-ap scan** command. To view the database of detected access points, use the **show rogue-ap** command from the Exec level.

```

Enterprise AP(config)#interface wireless g                               6-90
Enter Wireless configuration commands, one per line.
Enterprise AP(if-wireless g)#rogue-ap enable                             6-115
configure either syslog or trap or both to receive the rogue APs detected.
Enterprise AP(if-wireless g)#rogue-ap duration 200                       6-117
Enterprise AP(if-wireless g)#rogue-ap interval 120                       6-117
Enterprise AP(if-wireless g)#rogue-ap scan                               6-118
Enterprise AP(if-wireless g)#rogueApDetect Completed (Radio G) : 5 APs detected
rogueAPDetect (Radio G): refreshing ap database now

Enterprise AP(if-wireless g)#exit
Enterprise AP#show rogue-ap                                             6-119

802.11a Channel : Rogue AP Status
AP Address(BSSID)              SSID      Channel(MHz) RSSI
=====
802.11g Channel : Rogue AP Status
AP Address(BSSID)              SSID      Channel(MHz) RSSI
=====
00-04-e2-2a-37-23              WLAN1AP   11(2462 MHz)  17
00-04-e2-2a-37-3d              ANY       7(2442 MHz)   42
00-04-e2-2a-37-49              WLAN1AP   9(2452 MHz)   42
00-90-d1-08-9d-a7              WLAN1AP   1(2412 MHz)   12
00-30-f1-fb-31-f4              WLAN     6(2437 MHz)   16
Enterprise AP#

```

Configuring Common Radio Settings

To configure common radio settings, select the Radio Settings page, and scroll down to below the VAP (Virtual Access Point) radio settings.

Turbo Mode : Disable Enable

Radio Channel : 56 ch, 5.280 GHz

Auto Channel Select : Disable Enable

Transmit Power 100%

Maximum Supported Rate 54 Mbps

Maximum Association Client : 64

Antenna ID : id=0x0000, module=Default Antenna

Antenna Control Method : Diversity

Antenna Location : Indoor

MIC Mode : Hardware Software

Super A : Disable Enable

Beacon Interval (20-1000) 100 TUs

Data Beacon Rate (DTIM) (1-255) 1 Beacons

Fragment Length (256-2346) 2346 Bytes

RTS Threshold (0-2347) 2347 Bytes

Turbo Mode – The normal 802.11a wireless operation mode provides connections up to 54 Mbps. Turbo Mode is an enhanced mode (not regulated in IEEE 802.11a) that provides a higher data rate of up to 108 Mbps. Enabling Turbo Mode allows the BSAP-1600 to provide connections up to 108 Mbps. (Default: Disabled)

Note: In normal mode, the BSAP-1600 provides a channel bandwidth of 20 MHz, and supports the maximum number of channels permitted by local regulations (e.g., 13 channels for the United States). In Turbo Mode, the channel bandwidth is increased to 40 MHz to support the increased data rate. However, this reduces the number of channels supported (e.g., 5 channels for the United States).

Note: Check your country’s regulations to see if Turbo Mode is allowed.

Radio Channel – The radio channel that the BSAP-1600 uses to communicate with wireless clients. When multiple BSAP-1600s are deployed in the same area, set the channel on neighboring BSAP-1600s at least four channels apart to avoid interference with each other. For example, in the United States you can deploy up to four BSAP-1600s in the same area (e.g., channels 36, 56, 149, 165). Also note that the channel for wireless clients is automatically set to the same as that used by the BSAP-1600 to which it is linked. (Default: Channel 60 for normal mode, and channel 42 for Turbo mode)

Normal Mode	
60 ch, 5.300 GHz	▼
44 ch, 5.220 GHz	▲
48 ch, 5.240 GHz	
52 ch, 5.260 GHz	
56 ch, 5.280 GHz	
60 ch, 5.300 GHz	
64 ch, 5.320 GHz	
149 ch, 5.745 GHz	
153 ch, 5.765 GHz	
157 ch, 5.785 GHz	
161 ch, 5.805 GHz	
165 ch, 5.825 GHz	▼

Turbo Mode	
42 ch, 5.210 GHz	▼
42 ch, 5.210 GHz	
50 ch, 5.250 GHz	
58 ch, 5.290 GHz	
152 ch, 5.760 GHz	
160 ch, 5.800 GHz	

Auto Channel Select – Enables the BSAP-1600 to automatically select an unoccupied radio channel. (Default: Enabled)

Note: Check your country's regulations to see if Auto Channel can be disabled.

Transmit Power – Adjusts the power of the radio signals transmitted from the BSAP-1600. The higher the transmission power, the farther the transmission range. Power selection is not just a trade off between coverage area and maximum supported clients. You also have to ensure that high-power signals do not interfere with the operation of other radio devices in the service area. (Options: 100%, 50%, 25%, 12%, minimum; Default: 100%)

Note: When operating the BSAP-1600 using 5 GHz channels in a European Community country, the end user and installer are obligated to operate the device in accordance with European regulatory requirements for Transmit Power Control (TPC).

Maximum Supported Rate – The maximum data rate at which the BSAP-1600 transmits unicast packets on the wireless interface. The maximum transmission distance is affected by the data rate. The lower the data rate, the longer the transmission distance. (Options: 54, 48, 36, 24 Mbps; Default: 54 Mbps)

Maximum Associated Clients – Sets the maximum number of simultaneous clients that can be associated with a VAP (Virtual Access Point) interface. (Range: 1-64 per VAP interface; Default: 64)

Antenna ID – Selects the antenna to be used by the BSAP-1600; either the integrated diversity antennas (the "Default Antenna") or an optional external antenna. The optional external antennas (if any) that are certified for use with the BSAP-1600 are listed in the drop-down menu. Selecting the correct antenna ID ensures that the BSAP-1600's radio transmissions are within regulatory power limits for the country of operation. (Default: Default Antenna)

Note: The Antenna ID must be selected in conjunction with the Antenna Control Method to configure proper use of any of the antenna options.

Antenna Control Method - Selects the use of both fixed antennas operating in diversity mode or a single antenna. (Default: Diversity)

- **Diversity:** The radio uses both antennas in a diversity system. Select this method when the Antenna ID is set to "Default Antenna" to use the BSAP-1600's diversity antennas configuration.

- **Right:** The radio only uses the antenna on the right side (the side closest to the BSAP-1600 LEDs). Select this method when using an optional external antenna that is connected to the right antenna connector.
- **Left:** The radio only uses the antenna on the left side (the side farthest from the BSAP-1600 LEDs). Select this method when using an optional external antenna that is connected to the left antenna connector.

Antenna Location – Selects the mounting location of the antenna in use; either “Indoor” or “Outdoor.” Selecting the correct location ensures that the BSAP-1600 only uses radio channels that are permitted in the country of operation. (Default: Indoor)

MIC Mode – The Michael Integrity Check (MIC) is part of the Temporal Key Integrity Protocol (TKIP) encryption used in Wi-Fi Protected Access (WPA) security. The MIC calculation is performed in the BSAP-1600 for each transmitted packet and this can impact throughput and performance. The BSAP-1600 supports a choice of software or hardware MIC calculation. The performance of the BSAP-1600 can be improved by selecting the best method for the specific deployment. (Default: Software)

- **Hardware:** Provides best performance when the number of supported clients is less than 27.
- **Software:** Provides the best performance for a large number of clients on one radio interface. Throughput may be reduced when both 802.11a and 802.11g interfaces are supporting a high number of clients simultaneously.

Super A – The Atheros proprietary Super A performance enhancements are supported by the BSAP-1600. These enhancements include bursting, compression, and fast frames. Maximum throughput ranges between 40 to 60 Mbps for connections to Atheros-compatible clients. (Default: Disabled)

Beacon Interval – The rate at which beacon signals are transmitted from the BSAP-1600. The beacon signals allow wireless clients to maintain contact with the BSAP-1600. They may also carry power-management information. (Range: 20-1000 TUs; Default: 100 TUs)

Data Beacon Rate – The rate at which stations in sleep mode must wake up to receive broadcast/multicast transmissions.

Known also as the Delivery Traffic Indication Map (DTIM) interval, it indicates how often the MAC layer forwards broadcast/multicast traffic, which is necessary to wake up stations that are using Power Save mode. The default value of 2 indicates that the BSAP-1600 will save all broadcast/multicast frames for the Basic Service Set (BSS) and forward them after every second beacon. Using smaller DTIM intervals delivers broadcast/multicast frames in a more timely manner, causing stations in Power Save mode to wake up more often and drain power faster. Using higher DTIM values reduces the power used by stations in Power Save mode, but delays the transmission of broadcast/multicast frames. (Range: 1-255 beacons; Default: 1 beacon)

Multicast Data Rate – The maximum data rate at which the BSAP-1600 transmits multicast and broadcast packets on the wireless interface. (Options: 24, 12, 6 Mbps; Default: 6 Mbps)

Fragmentation Length – Configures the minimum packet size that can be fragmented when passing through the BSAP-1600. Fragmentation of the PDUs (Package Data Unit) can increase the reliability of transmissions because it increases the probability of a successful transmission due to smaller frame size. If there is significant interference present, or collisions due to high network utilization, try setting the fragment size to send smaller fragments. This will speed up the retransmission of smaller frames. However, it is more efficient to set the fragment size larger if very little or no interference is present because it requires overhead to send multiple frames. (Range: 256-2346 bytes; Default: 2346 bytes)

RTS Threshold – Sets the packet size threshold at which a Request to Send (RTS) signal must be sent to a receiving station prior to the sending station starting communications. The BSAP-1600 sends RTS frames to a receiving station to negotiate the sending of a data frame. After receiving an RTS frame, the station sends a CTS (clear to send) frame to notify the sending station that it can start sending data.

If the RTS threshold is set to 0, the BSAP-1600 always sends RTS signals. If set to 2347, the BSAP-1600 never sends RTS signals. If set to any other value, and the packet size equals or exceeds the RTS threshold, the RTS/CTS (Request to Send / Clear to Send) mechanism will be enabled.

The BSAP-1600s contending for the medium may not be aware of each other. The RTS/CTS mechanism can solve this “Hidden Node Problem.” (Range: 0-2347 bytes; Default: 2347 bytes)

CLI Commands for the *Common Radio Settings* – From the global configuration mode, enter the **interface wireless a** command to access the 802.11a radio interface. From the 802.11a interface mode, you can access radio settings that apply to all VAP (Virtual Access Point) interfaces. Use the **turbo** command to enable this feature before setting the radio channel with the **channel** command. Set any other radio setting as required before enabling the VAP interface (with the **no shutdown** command). To view the current 802.11a radio settings for the VAP interface, use the **show interface wireless a [0~3]** command as shown on 6-97.

```

Enterprise AP(config)#interface wireless a                               6-90
Enter Wireless configuration commands, one per line.
Enterprise AP(if-wireless a)#turbo                                       6-98
Enterprise AP(if-wireless a)#channel 42                                   6-100
Enterprise AP(if-wireless a)#transmit-power full                         6-100
Enterprise AP(if-wireless a)#speed 9                                     6-98
Enterprise AP(if-wireless a)#antenna id 0000                             6-103
Enterprise AP(if-wireless a)#antenna control right                       6-102
Enterprise AP(if-wireless a)#antenna location indoor                    6-104
Enterprise AP(if-wireless a)#mic_mode hardware                           6-126
Enterprise AP(if-wireless a)#super-a                                     6-107
Enterprise AP(if-wireless a)#beacon-interval 150                         6-104
Enterprise AP(if-wireless a)#beacon-interval 150                       6-104
Enterprise AP(if-wireless a)#dtim-period 5                               6-105
Enterprise AP(if-wireless a)#multicast-data-rate 6                       6-99
Enterprise AP(if-wireless a)#fragmentation-length 512                   6-106
Enterprise AP(if-wireless a)#rts-threshold 256                           6-106
Enterprise AP(if-wireless a)#

```

**Configuring
Wi-Fi
Multimedia**

Wireless networks offer an equal opportunity for all devices to transmit data from any type of application. Although this is acceptable for most applications, multimedia applications (with audio and video) are particularly sensitive to the delay and throughput variations that result from this “equal opportunity” wireless access method. For multimedia applications to run well over a wireless network, a Quality of Service (QoS) mechanism is required to prioritize traffic types and provide an “enhanced opportunity” wireless access method.

The BSAP-1600 implements QoS using the Wi-Fi Multimedia (WMM) standard. Using WMM, the BSAP-1600 is able to prioritize traffic and optimize performance when multiple applications compete for wireless network bandwidth at the same time. WMM employs techniques that are a subset of the developing IEEE 802.11e QoS standard and it enables the BSAP-1600 to inter operate with both WMM-enabled clients and other devices that may lack any WMM functionality.

Access Categories — WMM defines four access categories (ACs): voice, video, best effort, and background. These categories correspond to traffic priority levels and are mapped to IEEE 802.1P priority tags (see Table 6-4 on page 6-52). The direct mapping of the four ACs to 802.1P priorities is specifically intended to facilitate inter operability with other wired network QoS policies. While the four ACs are specified for specific types of traffic, WMM allows the priority levels to be configured to match any network-wide QoS policy. WMM also specifies a protocol that access points can use to communicate the configured traffic priority levels to QoS-enabled wireless clients.

Table 6-4: WMM Access Categories

Access Category	WMM Designation	Description	802.1P Tags
AC_VO (AC3)	Voice	Highest priority, minimum delay. Time-sensitive data such as VoIP (Voice over IP) calls.	7, 6
AC_VI (AC2)	Video	High priority, minimum delay. Time-sensitive data such as streaming video.	5, 4
AC_BE (AC0)	Best Effort	Normal priority, medium delay and throughput. Data only affected by long delays. Data from applications or devices that lack QoS capabilities.	0, 3
AC_BK (AC1)	Background	Lowest priority. Data with no delay or throughput requirements, such as bulk data transfers.	2, 1

WMM Operation — WMM uses traffic priority based on the four ACs; Voice, Video, Best Effort, and Background. The higher the AC priority, the higher the probability that data is transmitted.

When the BSAP-1600 forwards traffic, WMM adds data packets to four independent transmit queues, one for each AC, depending on the 802.1P priority tag of the packet. Data packets without a priority tag are always added to the Best Effort AC queue. From the four queues, an internal “virtual” collision resolution mechanism first selects data with the highest priority to be granted a transmit opportunity. Then the same collision resolution mechanism is used externally to determine which device has access to the wireless medium.

For each AC queue, the collision resolution mechanism is dependent on two timing parameters:

- AIFSN (Arbitration Inter-Frame Space Number), a number used to calculate the minimum time between data frames
- CW (Contention Window), a number used to calculate a random backoff time

After a collision detection, a backoff wait time is calculated. The total wait time is the sum of a minimum wait time (Arbitration Inter-Frame Space, or AIFS) determined from the AIFSN, and a random backoff time calculated from a value selected from zero to the CW. The CW value varies within a configurable range. It starts at CWMin and doubles after every collision up to a maximum value, CWMax. After a successful transmission, the CW value is reset to its CWMin value.

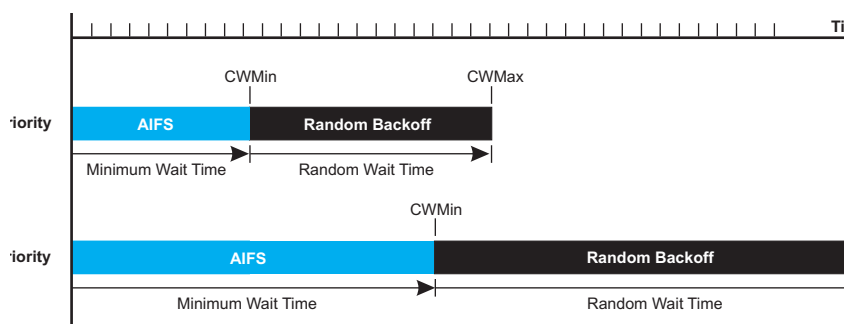

Figure 4-1. WMM Backoff Wait Times

For high-priority traffic, the AIFSN and CW values are smaller. The smaller values equate to less backoff and wait time, and therefore more transmit opportunities.

To configure WMM, select the Radio Settings page, and scroll down to the WMM configuration settings.

WMM : Disable Support Required

WMM Acknowledge Policy :

AC0 (Best Effort)	<input checked="" type="radio"/> Acknowledge <input type="radio"/> No Acknowledge
AC1 (Background)	<input checked="" type="radio"/> Acknowledge <input type="radio"/> No Acknowledge
AC2 (Video)	<input checked="" type="radio"/> Acknowledge <input type="radio"/> No Acknowledge
AC3 (Voice)	<input checked="" type="radio"/> Acknowledge <input type="radio"/> No Acknowledge

WMM BSS Parameters :

	AC0 (BestEffort)	AC1 (Background)	AC2 (Video)	AC3 (Voice)
logCwMin	<input type="text" value="4"/>	<input type="text" value="4"/>	<input type="text" value="3"/>	<input type="text" value="2"/>
logCwMax	<input type="text" value="10"/>	<input type="text" value="10"/>	<input type="text" value="4"/>	<input type="text" value="3"/>
AIFSN	<input type="text" value="3"/>	<input type="text" value="7"/>	<input type="text" value="2"/>	<input type="text" value="2"/>
TXOP Limit	<input type="text" value="0"/>	<input type="text" value="0"/>	<input type="text" value="94"/>	<input type="text" value="47"/>
Admission Control	<input checked="" type="radio"/> Disable <input type="radio"/> Enable	<input checked="" type="radio"/> Disable <input type="radio"/> Enable	<input checked="" type="radio"/> Disable <input type="radio"/> Enable	<input checked="" type="radio"/> Disable <input type="radio"/> Enable

WMM AP Parameters :

	AC0 (BestEffort)	AC1 (Background)	AC2 (Video)	AC3 (Voice)
logCwMin	<input type="text" value="4"/>	<input type="text" value="4"/>	<input type="text" value="3"/>	<input type="text" value="2"/>
logCwMax	<input type="text" value="6"/>	<input type="text" value="10"/>	<input type="text" value="4"/>	<input type="text" value="3"/>
AIFSN	<input type="text" value="3"/>	<input type="text" value="7"/>	<input type="text" value="1"/>	<input type="text" value="1"/>
TXOP Limit	<input type="text" value="0"/>	<input type="text" value="0"/>	<input type="text" value="94"/>	<input type="text" value="47"/>
Admission Control	<input checked="" type="radio"/> Disable <input type="radio"/> Enable	<input checked="" type="radio"/> Disable <input type="radio"/> Enable	<input checked="" type="radio"/> Disable <input type="radio"/> Enable	<input checked="" type="radio"/> Disable <input type="radio"/> Enable

WMM – Sets the WMM operational mode on the BSAP-1600. When enabled, the parameters for each AC queue will be employed on the BSAP-1600 and QoS capabilities are advertised to WMM-enabled clients. (Default: Support)

- **Disable:** WMM is disabled.
- **Support:** WMM will be used for any associated device that supports this feature. Devices that do not support this feature may still associate with the BSAP-1600.
- **Required:** WMM must be supported on any device trying to associated with the BSAP-1600. Devices that do not support this feature will not be allowed to associate with the BSAP-1600.

WMM Acknowledge Policy – By default, all wireless data transmissions require the sender to wait for an acknowledgement from the receiver. WMM allows the acknowledgement wait time to be turned off for each Access Category (AC). Although this increases data throughput, it can also result in a high number of errors when traffic levels are heavy. (Default: Acknowledge)

WMM BSS Parameters – These parameters apply to the wireless clients.

WMM AP Parameters – These parameters apply to the BSAP-1600.

- **logCWMin** (Minimum Contention Window) – The initial upper limit of the random backoff wait time before wireless medium access can be attempted. The initial wait time is a random value between zero and the CWMin value. Specify the CWMin value in the range 0-15 microseconds. Note that the CWMin value must be equal or less than the CWMax value.
- **logCWMax** (Maximum Contention Window) – The maximum upper limit of the random backoff wait time before wireless medium access can be attempted. The contention window is doubled after each detected collision up

to the CWMax value. Specify the CWMax value in the range 0-15 microseconds. Note that the CWMax value must be greater or equal to the CWMin value.

- **AIFS (Arbitration Inter-Frame Space)** – The minimum amount of wait time before the next data transmission attempt. Specify the AIFS value in the range 0-15 microseconds.
- **TXOP Limit (Transmit Opportunity Limit)** – The maximum time an AC transmit queue has access to the wireless medium. When an AC queue is granted a transmit opportunity, it can transmit data for a time up to the TxOpLimit. This data bursting greatly improves the efficiency for high data-rate traffic. Specify a value in the range 0-65535 microseconds.
- **Admission Control** – The admission control mode for the access category. When enabled, clients are blocked from using the access category. (Default: Disabled)

Key Type – See Wired Equivalent Privacy (WEP) .

CLI Commands for WMM – Enter interface wireless mode and type **wmm required** for clients that want to associate with the BSAP-1600. The **wmm-acknowledge-policy** command is used to enable or disable a policy for each access category. The **wmmparms** command defines detailed WMM parameters.

Enterprise AP(if-wireless a)#wmm required	6-137
Enterprise AP(if-wireless a)#wmm-acknowledge-policy 0 noack	6-137
Enterprise AP(if-wireless a)#wmmparms ap 0 4 6 3 1 1	6-138

To view the current 802.11a radio settings for the VAP (Virtual Access Point) interface, use the **show interface wireless a [0-3]** command.

```

Enterprise AP#show interface wireless a 0                               6-112

Wireless Interface Information
=====
-----Identification-----
Description                   : Enterprise 802.11a Access Point
SSID                          : VAP_TEST_11A 0
Turbo Mode                    : DISABLED
Channel                       : 36 (AUTO)
Status                        : DISABLED
MAC Address                   : 00:12:cf:05:95:0c
-----802.11 Parameters-----
Transmit Power                : FULL (16 dBm)
Max Station Data Rate        : 54Mbps
Multicast Data Rate          : 6Mbps
Fragmentation Threshold      : 2346 bytes
RTS Threshold                 : 2347 bytes
Beacon Interval              : 100 TUs
Authentication Timeout Interval : 60 Mins
Association Timeout Interval  : 30 Mins
DTIM Interval                 : 1 beacon
Maximum Association          : 64 stations
MIC Mode                     : Software
Super A                      : Disabled
VLAN ID                       : 1
-----Security-----
Closed System                 : Disabled
Multicast cipher              : WEP
WPA clients                   : TKIP and AES
WPA Key Mgmt Mode             : PRE SHARED KEY
WPA PSK Key Type              : PASSPHRASE
Encryption                   : DISABLED
Default Transmit Key          : 1
Common Static Keys            : Key 1: EMPTY      Key 2: EMPTY
                               Key 3: EMPTY      Key 4: EMPTY
Authentication Type           : OPEN
-----802.1x-----
802.1x                        :
Broadcast Key Refresh Rate    : 30 min
Session Key Refresh Rate      : 30 min
802.1x Session Timeout Value  : 0 min
-----Antenna-----
Antenna Control method        : Diversity
Antenna ID                    : 0x0000(Default Antenna)
Antenna Location              : Indoor

```

```

-----Quality of Service-----
WMM Mode : SUPPORTED
WMM Acknowledge Policy
AC0(Best Effort) : Ack
AC1(Background) : Acknowledge
AC2(Video) : Acknowledge
AC3(Voice) : Acknowledge
WMM BSS Parameters
AC0(Best Effort) : logCwMin: 4 logCwMax: 10 AIFSN: 3
Admission Control: No
TXOP Limit: 0.000 ms
AC1(Background) : logCwMin: 4 logCwMax: 10 AIFSN: 7
Admission Control: No
TXOP Limit: 0.000 ms
AC2(Video) : logCwMin: 3 logCwMax: 4 AIFSN: 2
Admission Control: No
TXOP Limit: 3.008 ms
AC3(Voice) : logCwMin: 2 logCwMax: 3 AIFSN: 2
Admission Control: No
TXOP Limit: 1.504 ms
WMM AP Parameters
AC0(Best Effort) : logCwMin: 4 logCwMax: 6 AIFSN: 3
Admission Control: No
TXOP Limit: 0.000 ms
AC1(Background) : logCwMin: 4 logCwMax: 10 AIFSN: 7
Admission Control: No
TXOP Limit: 0.000 ms
AC2(Video) : logCwMin: 3 logCwMax: 4 AIFSN: 1
Admission Control: No
TXOP Limit: 3.008 ms
AC3(Voice) : logCwMin: 2 logCwMax: 3 AIFSN: 1
Admission Control: No
TXOP Limit: 1.504 ms
=====
Enterprise AP#

```

Radio Settings G (802.11g)

The IEEE 802.11g standard operates within the 2.4 GHz band at up to 54 Mbps. Also note that because the IEEE 802.11g standard is an extension of the IEEE 802.11b standard, it allows clients with 802.11b wireless network cards to associate to an 802.11g access point.

First configure the radio settings that apply to the individual VAPs (Virtual Access Point) and the common radio settings that apply to all of the 802.11g interfaces. After you have configured the radio settings, go to the Security page under the 802.g Interface (Security), enable the radio service for any of the VAP interfaces, and then set an SSID to identify the wireless network service provided by each VAP. Remember that only clients with the same SSID can associate with a VAP.

Note: You must first enable VAP interface 0 before the other interfaces can be enabled.

Most of the 802.11g commands are identical to those used by the 802.11a interface. For information on these commands, refer to the following sections:

- Configuring VAP Radio Settings
- Configuring Rogue AP Detection
- Configuring Common Radio Settings
- Configuring Wi-Fi Multimedia

Only the radio settings specific to the 802.11g interface are included in this section. To configure the 802.11g radio settings, select the Radio Settings page.

Radio Channel :

Auto Channel Select : Disable Enable

Transmit Power

Maximum Station Data Rate Mbps

Maximum Association Client :

Antenna ID :

Antenna Control Method :

Antenna Location :

MIC Mode : Hardware Software

Super G : Disable Enable

Radio Mode : b & g mixed mode g only mode b only mode

Preamble Length : Long Short

Beacon Interval (20-1000) TUs

Data Beacon Rate (DTIM) (1-255) Beacons

Fragmentation Threshold (256-2346) Bytes

RTS Threshold (0-2347) Bytes

Radio Mode – Selects the operating mode for the 802.11g wireless interface. (Default: 802.11b+g)

- 802.11b+g: Both 802.11b and 802.11g clients can communicate with the BSAP-1600 (up to 54 Mbps).
- 802.11b only: Both 802.11b and 802.11g clients can communicate with the BSAP-1600, but 802.11g clients can only transfer data at 802.11b standard rates (up to 11 Mbps).
- 802.11g only: Only 802.11g clients can communicate with the BSAP-1600 (up to 54 Mbps).

Radio Channel – The radio channel that the BSAP-1600 uses to communicate with wireless clients. When multiple BSAP-1600s are deployed in the same area, set the channel on neighboring BSAP-1600s at least five channels apart to avoid interference with each other. For example, in the United States you can deploy up to three BSAP-1600s in the same area (e.g., channels 1, 6, 11). Also note that the channel for wireless clients is automatically set to the same as that used by the BSAP-1600 to which it is linked. (Range: 1-11; Default: 1)

Auto Channel Select – Enables the BSAP-1600 to automatically select an unoccupied radio channel. (Default: Enabled)

Maximum Station Data Rate – The maximum data rate at which the BSAP-1600 transmits unicast packets on the wireless interface. The maximum transmission distance is affected by the data rate. The lower the data rate, the longer the transmission distance. (Default: 54 Mbps)

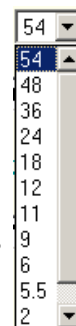

Super G – The Atheros proprietary Super G performance enhancements are supported by the BSAP-1600. These enhancements include bursting, compression, fast frames and dynamic turbo. Maximum throughput ranges between 40 to 60 Mbps for connections to Atheros-compatible clients. (Default: Disabled)

Preamble – Sets the length of the signal preamble that is used at the start of a data transmission. (Default: Long)

- Long: Sets the preamble to long (192 microseconds). Using a long preamble ensures the BSAP-1600 can support all 802.11b and 802.11g clients.
- Short or Long: Sets the preamble according to the capability of clients that are currently associated. Uses a short preamble (96 microseconds) if all associated clients can support it, otherwise a long preamble is used. The BSAP-1600 can increase data throughput when using a short preamble, but will only use a short preamble if it determines that all associated clients support it.

CLI Commands for the 802.11g Wireless Interface – From the global configuration mode, enter the **interface wireless g** command to access the 802.11g radio interface. The 802.11g radio can be forced to an 802.11g-only, 802.11b-only, or mixed 802.11b/g operating mode using the **radio-mode** command. You should set the desired operating mode before configuring channel settings (the default is mixed 802.11b/g operation). Select a radio channel or set selection to Auto using the **channel** command. Set any other radio settings as required before enabling the VAP (Virtual Access Point) interface (with the **no shutdown** command). To view the current 802.11g radio settings for the VAP interface, use the **show interface wireless g [0~3]** command as shown on 6-97.

```
Enterprise AP(config)#interface wireless g           6-90
Enter Wireless configuration commands, one per line.
  Enterprise AP(if-wireless g)#radio-mode g         6-101
Enterprise AP(if-wireless g)#channel auto          6-100
Enterprise AP(if-wireless a)#transmit-power full   6-100
Enterprise AP(if-wireless a)#super-g              6-108
Enterprise AP(if-wireless g)#preamble short       6-102
Enterprise AP(if-wireless g)#
```

Security

The BSAP-1600 is configured by default as an “open system,” which broadcasts a beacon signal including the configured SSID. Wireless clients with an SSID setting of “any” can read the SSID from the beacon and automatically set their SSID to allow immediate connection to the nearest BSAP-1600.

To improve wireless network security, you have to implement two main functions:

- Authentication: It must be verified that clients attempting to connect to the network are authorized users.

- Traffic Encryption: Data passing between the BSAP-1600 and clients must be protected from interception and eavesdropping.

For a more secure network, the BSAP-1600 can implement one or a combination of the following security mechanisms:

- Wired Equivalent Privacy (WEP) A summary of wireless security considerations is listed in the following table.
- IEEE 802.1x Configuring 802.1x
- Wireless MAC address filtering
- Wi-Fi Protected Access (WPA or WPA2)

Both WEP and WPA security settings are configurable separately for each virtual access point (VAP) interface. MAC address filtering, and RADIUS server settings are global and apply to all VAP interfaces.

The security mechanisms that may be employed depend on the level of security required, the network and management resources available, and the software support provided on wireless clients.

A summary of wireless security considerations is listed in the following table.

Table 6-5: Wireless Security Considerations

Security Mechanism	Client Support	Implementation Considerations
WEP	Built-in support on all 802.11a and 802.11g devices	<ul style="list-style-type: none"> • Provides only weak security • Requires manual key management
WEP over 802.1x	Requires 802.1x client support in system or by add-in software (support provided in Windows 2000 SP3 or later and Windows XP)	<ul style="list-style-type: none"> • Provides dynamic key rotation for improved WEP security • Requires configured RADIUS server • 802.1x EAP type may require management of digital certificates for clients and server
MAC Address Filtering	Uses the MAC address of client network card	<ul style="list-style-type: none"> • Provides only weak user authentication • Management of authorized MAC addresses • Can be combined with other methods for improved security • Optionally configured RADIUS server
WPA over 802.1x Mode	Requires WPA-enabled system and network card driver (native support provided in Windows XP)	<ul style="list-style-type: none"> • Provides robust security in WPA-only mode (i.e., WPA clients only) • Offers support for legacy WEP clients, but with increased security risk (i.e., WEP authentication keys disabled) • Requires configured RADIUS server • 802.1x EAP type may require management of digital certificates for clients and server

Table 6-5: Wireless Security Considerations

WPA PSK Mode	Requires WPA-enabled system and network card driver (native support provided in Windows XP)	<ul style="list-style-type: none"> • Provides good security in small networks • Requires manual management of pre-shared key
WPA2 with 802.1x	Requires WPA-enabled system and network card driver (native support provided in Windows XP)	<ul style="list-style-type: none"> • Provides the strongest security in WPA2-only mode • Provides robust security in mixed mode for WPA and WPA2 clients • Offers fast roaming for time-sensitive client applications • Requires configured RADIUS server • 802.1x EAP type may require management of digital certificates for clients and server • Clients may require hardware upgrade to be WPA2 compliant
WPA2 PSK Mode	Requires WPA-enabled system and network card driver (native support provided in Windows XP)	<ul style="list-style-type: none"> • Provides robust security in small networks • Requires manual management of pre-shared key • Clients may require hardware upgrade to be WPA2 compliant

Note: You must enable data encryption through the web or CLI in order to enable all types of encryption (WEP, TKIP, or AES) in the BSAP-1600.

The BSAP-1600 can simultaneously support clients using various different security mechanisms. The configuration for these security combinations are outlined in the following table. Note that MAC address authentication can be configured independently to work with all security mechanisms and is indicated separately in the table. Required RADIUS server support is also listed.

Table 6-6: Security Combinations

Client Security Combination	Configuration Summary^a	MAC Authentication^b	RADIUS Server
No encryption and no authentication	Interface Detail Settings: Authentication: Open System Encryption: Disable 802.1x: Disable	Local, RADIUS, or Disabled	Yes ³
Static WEP only (with or without shared key authentication)	Enter 1 to 4 WEP keys Select a WEP transmit key for the interface Interface Detail Settings: Authentication: Shared Key or Open System Encryption: Enable 802.1x: Disable	Local, RADIUS, or Disabled	Yes ^c

Table 6-6: Security Combinations

Dynamic WEP (802.1x) only	Interface Detail Settings: Authentication: Open System Encryption: Enable 802.1x: Required Set 802.1x key refresh and reauthentication rates	Local, RADIUS, or Disabled	Yes
802.1x WPA only	Interface Detail Settings: Authentication: WPA Encryption: Enable WPA Configuration: Required Cipher Suite: TKIP 802.1x: Required Set 802.1x key refresh and reauthentication rates	Local only	Yes
WPA Pre-Shared Key only	Interface Detail Settings: Authentication: WPA-PSK Encryption: Enable WPA Configuration: Required Cipher Configuration: TKIP 802.1x: Disable WPA Pre-shared Key Type: Hexadimal or Alphanumeric Enter a WPA Pre-shared key	Local only	No
Static and dynamic (802.1x) WEP keys	Enter 1 to 4 WEP keys Select a WEP transmit key Interface Detail Settings: Authentication: Open System Encryption: Enable 802.1x: Supported Set 802.1x key refresh and reauthentication rates	Local, RADIUS, or Disabled	Yes
Dynamic WEP and 802.1x WPA	Interface Detail Settings: Authentication: WPA Encryption: Enable WPA Configuration: Supported Cipher Suite: WEP 802.1x: Required Set 802.1x key refresh and reauthentication rates	Local or Disabled	Yes
Static and dynamic (802.1x) WEP keys and 802.1x WPA	Enter 1 to 4 WEP keys Select a WEP transmit key Interface Detail Settings: Authentication: WPA Encryption: Enable WPA Configuration: Supported Cipher Suite: WEP 802.1x: Supported Set 802.1x key refresh and reauthentication rates	Local or Disabled	Yes

Table 6-6: Security Combinations

802.1x WPA2 only	Interface Detail Settings: Authentication: WPA2 Encryption: Enable WPA Configuration: Required Cipher Suite: AES-CCMP 802.1x: Required Set 802.1x key refresh and reauthentication rates	Local or Disabled	Yes
WPA2 Pre-Shared Key only	Interface Detail Settings: Authentication: WPA2-PSK Encryption: Enable WPA Configuraton: Required Cipher Suite: AES-CCMP 802.1x: Disable WPA Pre-shared Key Type: Hexadicmal or Alphanumeric Enter a WPA Pre-shared key	Local or Disabled	No
802.1x WPA-WPA2 Mixed Mode	Interface Detail Settings: Authentication: WPA-WPA2-mixed Encryption: Enable WPA Configuration: Required Cipher Suite: TKIP 802.1x: Required Set 802.1x key refresh and reauthentication rates	Local or Disabled	Yes
WPA-WPA2 Mixed Mode Pre-Shared Key	Interface Detail Settings: Authentication: WPA-WPA2-PSK-mixed Encryption: Enable WPA Configuration: Required Cipher Suite: TKIP 802.1x: Disable WPA Pre-shared Key Type: Hexadicmal or Alphanumeric Enter a WPA Pre-shared key	Local or Disabled	No

a.The configuration summary does not include the set up for MAC authentication (“Authentication” on page 6-10) or RADIUS server (“RADIUS” on page 6-6).

b.The configuration of RADIUS MAC authentication together with 802.1x WPA or WPA Pre-shared Key is not supported.

c.RADIUS server required only when RADIUS MAC authentication is configured.

Note: If you choose to configure RADIUS MAC authentication together with 802.1x, the RADIUS MAC address authentication occurs prior to 802.1x authentication. Only when RADIUS MAC authentication succeeds is 802.1x authentication performed. When RADIUS MAC authentication fails, 802.1x authentication is not performed.

Enabling the VAPs

Before enabling the Virtual Access Point (VAP) radio interfaces, first configure all of the relevant radio settings (“Radio Settings A (802.11a)” on page 6-44 or “Radio Settings G (802.11g)” on page 6-57)

After you have configured the radio settings, select Security under Radio A or Radio G, set an SSID to identify the wireless network service provided by each VAP you want to use, and then click Apply to save your settings.

Before enabling the radio service for any VAP, first configure the WEP, WPA, and 802.1x security settings described in the following sections. After you have finished configuring the security settings, return to the main Security page shown below, start the required VAP interfaces by clicking the Enable checkbox, and then click Apply.

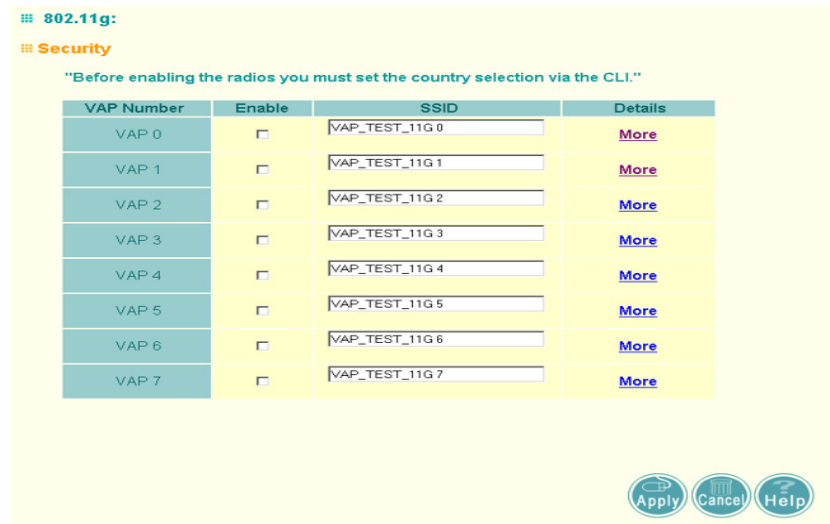

Enable – Enables radio communications on the VAP (Virtual Access Point) interface. (Default: Disabled)

Note: You must first enable VAP interface 0 before you can enable other VAP interfaces.

SSID – The name of the basic service set provided by a VAP interface. Clients that want to connect to the network through the BSAP-1600 must set their SSID to the same as that of an access point VAP interface. (Default: VAP_TEST_11A # (0-3); Range: 1-32 characters)

Wired Equivalent Privacy (WEP)

WEP provides a basic level of security, preventing unauthorized access to the network, and encrypting data transmitted between wireless clients and the BSAP-1600. WEP uses static shared keys (fixed-length hexadecimal or alphanumeric strings) that are manually distributed to all clients that want to use the network.

WEP is the security protocol initially specified in the IEEE 802.11 standard for wireless communications. Unfortunately, WEP has been found to be seriously flawed and cannot be recommended for a high level of network security. For more robust wireless security, the BSAP-1600 provides Wi-Fi Protected Access (WPA) for improved data encryption and user authentication.

Setting up shared keys enables the basic IEEE 802.11 Wired Equivalent Privacy (WEP) on the BSAP-1600 to prevent unauthorized access to the network.

If you choose to use WEP shared keys instead of an open system, be sure to define at least one static WEP key for user authentication and data encryption. Also, be sure that the WEP shared keys are the same for each client in the wireless network.

Note that all clients share the same keys, which are used for user authentication and data encryption. Up to four keys can be specified. These four keys are used for all VAP (Virtual Access Point) interfaces on the same radio.

To set up WEP shared keys, click Radio Settings under Radio A or Radio G.

VAP 0	VAP 1	VAP 2	VAP 3	Key Number	Shared Key Setup	Key
<input type="radio"/>	<input type="radio"/>	<input type="radio"/>	<input type="radio"/>	Key 1	<input type="radio"/> 64 Bit <input type="radio"/> 128 Bit <input type="radio"/> 152 Bit <input type="radio"/> None	<input type="text"/>
<input type="radio"/>	<input type="radio"/>	<input type="radio"/>	<input type="radio"/>	Key 2	<input type="radio"/> 64 Bit <input type="radio"/> 128 Bit <input type="radio"/> 152 Bit <input type="radio"/> None	<input type="text"/>
<input type="radio"/>	<input type="radio"/>	<input type="radio"/>	<input type="radio"/>	Key 3	<input type="radio"/> 64 Bit <input type="radio"/> 128 Bit <input type="radio"/> 152 Bit <input type="radio"/> None	<input type="text"/>
<input type="radio"/>	<input type="radio"/>	<input type="radio"/>	<input type="radio"/>	Key 4	<input type="radio"/> 64 Bit <input type="radio"/> 128 Bit <input type="radio"/> 152 Bit <input type="radio"/> None	<input type="text"/>

Key Type – Select the preferred method of entering WEP encryption keys on the BSAP-1600 and enter up to four keys:

- Hexadecimal: Enter keys as 10 hexadecimal digits (0-9 and A-F) for 64 bit keys, 26 hexadecimal digits for 128 bit keys, or 32 hexadecimal digits for 152 bit keys (802.11a radio only). This is the default setting.
- Alphanumeric: Enter keys as 5 alphanumeric characters for 64 bit keys, 13 alphanumeric characters for 128 bit keys, or 16 alphanumeric characters for 152 bit keys (802.11a radio only).

Key Number – Selects the key number to use for encryption for each VAP interface. If the clients have all four keys configured to the same values, you can change the encryption key to any of the four settings without having to update the client keys. (Default: Key 1)

Shared Key Setup – Select 64 Bit, 128 Bit, or 152 Bit key length. Note that the same size of encryption key must be supported on all wireless clients. (Default: None)

Note: Key index and type must match that configured on the clients.

Note: In a mixed-mode environment with clients using static WEP keys and WPA, select WEP transmit key index 2, 3, or 4. The BSAP-1600 uses transmit key index 1 for the generation of dynamic keys.

To enable WEP shared keys for a VAP interface, click Security under Radio A or Radio G. Then, select the VAP interface that will use WEP keys by clicking More, and configure the Authentication Type Setup and Encryption fields.

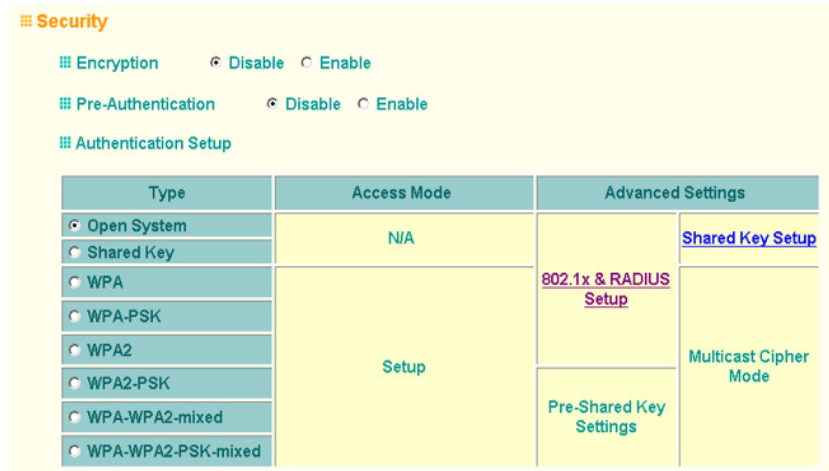

Authentication Type Setup – Sets the BSAP-1600 to communicate as an open system that accepts network access attempts from any client, or with clients using pre-configured static shared keys. (Default: Open System)

- Open System: If you don't set up any other security mechanism on the BSAP-1600, the network has no protection and is open to all users. This is the default setting.
- Shared Key: Sets the BSAP-1600 to use WEP shared keys. If this option is selected, you must configure at least one key on the BSAP-1600 and all clients.

Note: To use 802.1x on wireless clients requires a network card driver and 802.1x client software that supports the EAP authentication type that you want to use. Windows 2000 SP3 or later and Windows XP provide 802.1x client support. Windows XP also provides native WPA support. Other systems require additional client software to support 802.1x and WPA.

Encryption – Enable or disable the BSAP-1600 to use data encryption (WEP, TKIP, or AES). If this option is selected when using static WEP keys, you must configure at least one key on the BSAP-1600 and all clients. (Default: Disabled)

Note: You must enable data encryption through the web or CLI in order to enable all types of encryption (WEP, TKIP, or AES) in the BSAP-1600.

CLI Commands for WEP Shared Key Security – To enable WEP shared key security for the 802.11g interface, use the **interface wireless g** command from the CLI configuration mode to access the interface mode for the 802.11g radio. First use the **key** command to define up to four WEP keys that can be used for all VAP (Virtual Access Point) interfaces on the radio. Then use the **vap** command to access each VAP interface to configure other security settings.

From the VAP interface configuration mode, use the **auth** command to enable WEP shared-key authentication, which enables encryption automatically. Then set one key as the transmit key for the VAP interface using the **transmit-key** command. To view the current security settings, use the **show interface wireless g [0-3]** command from the Exec mode.

```

Enterprise AP(config)#interface wireless g                               6-90
Enter Wireless configuration commands, one per line.
Enterprise AP(if-wireless g)#key 1 128 ascii abcdeabcdeabc             6-123
Enterprise AP(if-wireless g)#vap 0                                     6-97
Enterprise AP(if-wireless g: VAP[0])#auth shared-key                   6-123
Data Encryption is set to enabled.
Remember to set the share key using "key" command.
Enterprise AP(if-wireless g: VAP[0])#transmit-key 1                   6-124
Enterprise AP(if-wireless g: VAP[0])#exit
Enterprise AP#show interface wireless g 0                              6-112
Wireless Interface Information
-----
-----Identification-----
Description                    : Enterprise 802.11g Access Point
SSID                           : VAP_TEST_11G 0
Channel                         : 11 (AUTO)
Status                          : DISABLED
MAC Address                     : 00:12:cf:05:95:08
-----802.11 Parameters-----
Radio Mode                     : b & g mixed mode
Transmit Power                 : FULL (5 dBm)
Max Station Data Rate          : 54Mbps
Multicast Data Rate            : 5.5Mbps
Fragmentation Threshold        : 2346 bytes
RTS Threshold                  : 2347 bytes
Beacon Interval                : 100 TUs
Authentication Timeout Interval : 60 Mins
Association Timeout Interval   : 30 Mins
DTIM Interval                  : 1 beacon
Preamble Length                : SHORT-OR-LONG
Maximum Association            : 64 stations
MIC Mode                       : Software
Super G                        : Disabled
VLAN ID                        : 1
-----Security-----
Closed System                  : Disabled
Multicast cipher               : WEP
Unicast cipher                 : TKIP and AES
WPA clients                    : DISABLED
WPA Key Mgmt Mode              : PRE SHARED KEY
WPA PSK Key Type               : PASSPHRASE
WPA PSK Key                    : EMPTY
PMKSA Lifetime                 : 720 minutes
Encryption                     : ENABLED
Default Transmit Key           : 1
Common Static Keys              : Key 1: EMPTY      Key 2: EMPTY
                                Key 3: EMPTY      Key 4: EMPTY
Pre-Authentication             : DISABLED
Authentication Type             : SHARED
-----802.1x-----
802.1x                         : DISABLED
Broadcast Key Refresh Rate     : 30 min
Session Key Refresh Rate       : 30 min
802.1x Session Timeout Value   : 0 min

```

```

-----Antenna-----
Antenna Control method      : Diversity
Antenna ID                  : 0x0000 (Default Antenna)
Antenna Location            : Indoor
-----Quality of Service-----
WMM Mode                    : SUPPORTED
WMM Acknowledge Policy
AC0 (Best Effort)           : Acknowledge
AC1 (Background)           : Acknowledge
AC2 (Video)                 : Acknowledge
AC3 (Voice)                 : Acknowledge
WMM BSS Parameters
AC0 (Best Effort)           : logCwMin: 4 logCwMax: 10 AIFSN: 3
                             Admission Control: No
                             TXOP Limit: 0.000 ms
AC1 (Background)           : logCwMin: 4 logCwMax: 10 AIFSN: 7
                             Admission Control: No
                             TXOP Limit: 0.000 ms
AC2 (Video)                 : logCwMin: 3 logCwMax: 4 AIFSN: 2
                             Admission Control: No
                             TXOP Limit: 3.008 ms
AC3 (Voice)                 : logCwMin: 2 logCwMax: 3 AIFSN: 2
                             Admission Control: No
                             TXOP Limit: 1.504 ms
WMM AP Parameters
AC0 (Best Effort)           : logCwMin: 4 logCwMax: 6 AIFSN: 3
                             Admission Control: No
                             TXOP Limit: 0.000 ms
AC1 (Background)           : logCwMin: 4 logCwMax: 10 AIFSN: 7
                             Admission Control: No
                             TXOP Limit: 0.000 ms
AC2 (Video)                 : logCwMin: 3 logCwMax: 4 AIFSN: 1
                             Admission Control: No
                             TXOP Limit: 3.008 ms
AC3 (Voice)                 : logCwMin: 2 logCwMax: 3 AIFSN: 1
                             Admission Control: No
                             TXOP Limit: 1.504 ms
=====
Enterprise AP#

```

CLI Commands for WEP over 802.1x Security – Use the **vap** command to access each VAP (Virtual Access Point) interface to configure the security settings. First set 802.1x to required using the **802.1x** command and set the **802.1x** key refresh rates. Then, use the **auth** command to select open system authentication and the **encryption** command to enable data encryption. To view the current security settings, use the **show interface wireless a [0-3]** or **show interface wireless g [0-3]** command (not shown in example).

```

Enterprise AP(if-wireless g)#vap 0
Enterprise AP(if-wireless g: VAP[0])#802.1x required          6-66
Enterprise AP(if-wireless g: VAP[0])#802.1x broadcast-key-refresh-rate 5          6-67
Enterprise AP(if-wireless g: VAP[0])#802.1x session-key-refresh-rate 5          6-68
Enterprise AP(if-wireless g: VAP[0])#802.1x session-timeout 300          6-68
Enterprise AP(if-wireless g: VAP[0])#auth open-system          6-123
Enterprise AP(if-wireless g: VAP[0])#encryption          6-122
Enterprise AP(if-wireless g: VAP[0])#

```

Wi-Fi Protected Access (WPA)

WPA employs a combination of several technologies to provide an enhanced security solution for 802.11 wireless networks.

The BSAP-1600 supports the following WPA components and features:

IEEE 802.1x and the Extensible Authentication Protocol (EAP): WPA employs 802.1x as its basic framework for user authentication and dynamic key management. The 802.1x client and RADIUS server should use an appropriate EAP type—such as EAP-TLS (Transport Layer Security), EAP-TTLS (Tunneled TLS), or PEAP (Protected EAP)—for strongest authentication. Working together, these

protocols provide “mutual authentication” between a client, the BSAP-1600, and a RADIUS server that prevents users from accidentally joining a rogue network. Only when a RADIUS server has authenticated a user’s credentials will encryption keys be sent to the BSAP-1600 and client.

Note: To implement WPA on wireless clients requires a WPA-enabled network card driver and 802.1x client software that supports the EAP authentication type that you want to use. Windows XP provides native WPA support, other systems require additional software.

Temporal Key Integrity Protocol (TKIP): WPA specifies TKIP as the data encryption method to replace WEP. TKIP avoids the problems of WEP static keys by dynamically changing data encryption keys. Basically, TKIP starts with a master (temporal) key for each user session and then mathematically generates other keys to encrypt each data packet. TKIP provides further data encryption enhancements by including a message integrity check for each packet and a re-keying mechanism, which periodically changes the master key.

WPA Pre-Shared Key Mode (WPA-PSK, WPA2-PSK): For enterprise deployment, WPA requires a RADIUS authentication server to be configured on the wired network. However, for small office networks that may not have the resources to configure and maintain a RADIUS server, WPA provides a simple operating mode that uses just a pre-shared password for network access. The Pre-Shared Key mode uses a common password for user authentication that is manually entered on the BSAP-1600 and all wireless clients. The PSK mode uses the same TKIP packet encryption and key management as WPA in the enterprise, providing a robust and manageable alternative for small networks.

Mixed WPA and WEP Client Support: WPA enables the BSAP-1600 to indicate its supported encryption and authentication mechanisms to clients using its beacon signal. WPA-compatible clients can likewise respond to indicate their WPA support. This enables the BSAP-1600 to determine which clients are using WPA security and which are using legacy WEP. The BSAP-1600 uses TKIP unicast data encryption keys for WPA clients and WEP unicast keys for WEP clients. The global encryption key for multicast and broadcast traffic must be the same for all clients, therefore it restricts encryption to a WEP key.

When access is opened to both WPA and WEP clients, no authentication is provided for the WEP clients through shared keys. To support authentication for WEP clients in this mixed mode configuration, you can use either MAC authentication or 802.1x authentication.

WPA2 – WPA was introduced as an interim solution for the vulnerability of WEP pending the ratification of the IEEE 802.11i wireless security standard. In effect, the WPA security features are a subset of the 802.11i standard. WPA2 includes the now ratified 802.11i standard, but also offers backward compatibility with WPA. Therefore, WPA2 includes the same 802.1x and PSK modes of operation and support for TKIP encryption. The main differences and enhancements in WPA2 can be summarized as follows:

- **Advanced Encryption Standard (AES):** WPA2 uses AES Counter-Mode encryption with Cipher Block Chaining Message Authentication Code (CBC-MAC) for message integrity. The AES Counter-Mode/CBCMAC Protocol

(AES-CCMP) provides extremely robust data confidentiality using a 128-bit key. The AES-CCMP encryption cipher is specified as a standard requirement for WPA2. However, the computational intensive operations of AES-CCMP requires hardware support on client devices. Therefore to implement WPA2 in the network, wireless clients must be upgraded to WPA2-compliant hardware.

- **WPA2 Mixed-Mode:** WPA2 defines a transitional mode of operation for networks moving from WPA security to WPA2. WPA2 Mixed Mode allows both WPA and WPA2 clients to associate to a common SSID interface. In mixed mode, the unicast encryption cipher (TKIP or AES-CCMP) is negotiated for each client. The BSAP-1600 advertises its supported encryption ciphers in beacon frames and probe responses. WPA and WPA2 clients select the cipher they support and return the choice in the association request to the BSAP-1600. For mixed-mode operation, the cipher used for broadcast frames is always TKIP. WEP encryption is not allowed.
- **Key Caching:** WPA2 provides fast roaming for authenticated clients by retaining keys and other security information in a cache, so that if a client roams away from a BSAP-1600 and then returns, re-authentication is not required. When a WPA2 client is first authenticated, it receives a Pairwise Master Key (PMK) that is used to generate other keys for unicast data encryption. This key and other client information form a Security Association that the BSAP-1600 names and holds in a cache.
- **Preauthentication:** Each time a client roams to another BSAP-1600 it has to be fully re-authenticated. This authentication process is time consuming and can disrupt applications running over the network. WPA2 includes a mechanism, known as pre-authentication, that allows clients to roam to a new BSAP-1600 and be quickly associated. The first time a client is authenticated to a wireless network it has to be fully authenticated. When the client is about to roam to another BSAP-1600 in the network, the BSAP-1600 sends pre-authentication messages to the new BSAP-1600 that include the client's security association information. Then when the client sends an association request to the new BSAP-1600, the client is known to be already authenticated, so it proceeds directly to key exchange and association.

To configure WPA, click Security under Radio A or Radio G. Select one of the VAP interfaces by clicking More. Select one of the WPA options in the Authentication Setup table, and then configure the parameters displayed beneath the table.

Security

Encryption Disable Enable

Pre-Authentication Disable Enable

Authentication Setup

Type	Access Mode	Advanced Settings	
<input type="radio"/> Open System	N/A		Shared Key Setup
<input type="radio"/> Shared Key			
<input checked="" type="radio"/> WPA	Setup	802.1x & RADIUS Setup	Multicast Cipher Mode
<input type="radio"/> WPA-PSK			
<input type="radio"/> WPA2		Pre-Shared Key Settings	
<input type="radio"/> WPA2-PSK			
<input type="radio"/> WPA-WPA2-mixed			
<input type="radio"/> WPA-WPA2-PSK-mixed			

WPA Configuration

Supported Mobile Unit may have WPA enabled to access AP

Required Mobile Unit must have WPA enabled to access AP

Cipher Suite

WEP Use WEP as cipher suite

TKIP Use TKIP as cipher suite

AES-CCMP Use AES-CCMP as cipher suite

The WPA configuration parameters are described below:

Encryption – You must enable data encryption in order to enable all types of encryption (WEP, TKIP, or AES) in the BSAP-1600.

Pre-Authentication – When using WPA2 over 802.1x, pre-authentication can be enabled, which allows clients to roam to a new BSAP-1600 and be quickly associated without performing full 802.1x authentication. (Default: Disabled)

Authentication Setup – To use WPA or WPA2, set the BSAP-1600 to one of the following options. If a WPA/WPA2 mode that operates over 802.1x is selected (WPA, WPA2, or WPA-WPA2-mixed), the 802.1x settings and RADIUS server details need to be configured. Be sure you have also configured a RADIUS server on the network before enabling authentication. If a WPA/WPA2 Pre-shared Key mode is selected (WPA-PSK, WPA2-PSK, or WPA-WPA2 PSK-Mixed), be sure to specify the key string.

- WPA: Clients using WPA over 802.1x are accepted for authentication.
- WPA-PSK: Clients using WPA with a Pre-shared Key are accepted for authentication.
- WPA2: Clients using WPA2 over 802.1x are accepted for authentication.
- WPA2-PSK: Clients using WPA2 with a Pre-shared Key are accepted for authentication.
- WPA-WPA2-mixed: Clients using WPA or WPA2 over 802.1x are accepted for authentication.

- WPA-WPA2-PSK-mixed: Clients using WPA or WPA2 with a Pre-shared Key are accepted for authentication.

WPA Configuration – Each VAP (Virtual Access Point) interface can be configured to allow only WPA-enabled clients to access the network (Required), or to allow access to both WPA and WEP clients (Supported). (Default: Required)

Cipher Suite – Selects an encryption method for the global key used for multicast and broadcast traffic, which is supported by all wireless clients.

- WEP: WEP is used as the multicast encryption cipher. You should select WEP only when both WPA and WEP clients are supported.
- TKIP: TKIP is used as the multicast encryption cipher.
- AES-CCMP: AES-CCMP is used as the multicast encryption cipher. AES-CCMP is the standard encryption cipher required for WPA2.

WPA Pre-Shared Key Type – If the WPA or WPA2 pre-shared-key mode is used, all wireless clients must be configured with the same key to communicate with the BSAP-1600.

- Hexadecimal – Enter a key as a string of 64 hexadecimal numbers.
- Alphanumeric – Enter a key as an easy-to-remember form of letters and numbers. The string must be from 8 to 63 characters, which can include spaces.

The configuration settings for WPA are summarized below:

Table 6-7: WPA Configuration Settings

WPA and WPA2 pre-shared key only	WPA and WPA2 over 802.1x
Encryption: Enabled Authentication Setup: WPA-PSK, WPA2-PSK, or WPA-WPA2-mixed Cipher Suite: WEP/TKIP/AES-CCMP WPA Pre-shared Key Type: Hex/ASCII	Encryption: Enabled Authentication Setup: WPA, WPA2, WPA-WPA2-mixed Cipher Suite: WEP/TKIP/AES-CCMP (requires RADIUS server to be specified)
1: You must enable data encryption in order to enable all types of encryption in the BSAP-1600. 2: Select TKIP when any WPA clients do not support AES. Select AES only if all clients support AES.	

CLI Commands for WPA Using Pre-shared Key Security – From the VAP (Virtual Access Point) interface configuration mode, use the **auth wpa-psk required** command to enable WPA Pre-shared Key security. To enter a key value, use the **wpa-pre-shared-key** command to specify a hexadecimal or alphanumeric key. To

view the current security settings, use the **show interface wireless a [0-3]** or **show interface wireless g [0-3]** command (not shown in example).

```

Enterprise AP(config)#interface wireless g                               6-90
Enter Wireless configuration commands, one per line.
Enterprise AP(if-wireless g)#vap 0
Enterprise AP(if-wireless g: VAP[0])#wpa-pre-shared-key
    passphrase-key agoodsecret                                         6-127
Enterprise AP(if-wireless g: VAP[0])#auth wpa-psk required
Data Encryption is set to Enabled.
WPA2 Clients Mode is set to Disabled.
WPA Clients Mode is set to Required.
WPA Multicast Cipher is set to TKIP.
WPA Unicast Cipher can accept TKIP only.
WPA Authentication is set to Pre-Shared Key.
Enterprise AP(if-wireless g: VAP[0])#

```

CLI Commands for *WPA Over 802.1x Security* – From the VAP interface configuration mode, use the **auth wpa required** command to select WPA over 802.1x security. Then set the 802.1x key refresh rates. To view the current security settings, use the **show interface wireless a [0-3]** or **show interface wireless g [0-3]** command (not shown in example).

```

Enterprise AP(config)#interface wireless g                               6-90
Enter Wireless commands, one per line.
Enterprise AP(if-wireless g)#vap 0
Enterprise AP(if-wireless g: VAP[0])#auth wpa required
Data Encryption is set to Enabled.
WPA2 Clients mode is set to Disabled.
WPA Clients Mode is set to Required.
WPA Multicast Cipher is set to TKIP.
WPA Unicast Cipher can accept TKIP only.
WPA Authentication is set to 802.1x Required.
Enterprise AP(if-wireless g: VAP[0])#802.1x broadcast-key-refresh-rate 5
Enterprise AP(if-wireless g: VAP[0])#802.1x
    session-key-refresh-rate 5                                         6-67
Enterprise AP(if-wireless g: VAP[0])#802.1x session-timeout 300      6-68
Enterprise AP(if-wireless g: VAP[0])#

```

Configuring 802.1x

IEEE 802.1x is a standard framework for network access control that uses a central RADIUS server for user authentication. This control feature prevents unauthorized access to the network by requiring an 802.1x client application to submit user credentials for authentication. The 802.1x standard uses the Extensible Authentication Protocol (EAP) to pass user credentials (either digital certificates, user names and passwords, or other) from the client to the RADIUS server. Client authentication is then verified on the RADIUS server before the BSAP-1600 grants client access to the network.

The 802.1x EAP packets are also used to pass dynamic unicast session keys and static broadcast keys to wireless clients. Session keys are unique to each client and are used to encrypt and correlate traffic passing between a specific client and the BSAP-1600. You can also enable broadcast key rotation, so the BSAP-1600 provides a dynamic broadcast key and changes it at a specified interval.

Open the Security page, and click More for one of the VAP (Virtual Access Point) interfaces.

802.11g: (VAP 1)

802.1x Setup :

Disable 802.1x authentications not allowed

Supported Clients may or may not use 802.1x

Required Client must use 802.1x

If 802.1x supported or required is selected, then [RADIUS setup](#) must be completed

Broadcast Key Refresh Rate minutes (0 = Disabled)

Session Key Refresh Rate minutes (0 = Disabled)

802.1x Reauthentication Refresh Rate minutes (0 = Disabled)

You can enable 802.1x as optionally supported or as required to enhance the security of the wireless network. (Default: Disable)

- **Disable:** The BSAP-1600 does not support 802.1x authentication for any wireless client. After successful wireless association with the BSAP-1600, each client is allowed to access the network.
- **Supported:** The BSAP-1600 supports 802.1x authentication only for clients initiating the 802.1x authentication process (i.e., the BSAP-1600 does not initiate 802.1x authentication). For clients initiating 802.1x, only those successfully authenticated are allowed to access the network. For those clients not initiating 802.1x, access to the network is allowed after successful wireless association with the BSAP-1600. The 802.1x supported mode allows access for clients not using WPA or WPA2 security.
- **Required:** The BSAP-1600 enforces 802.1x authentication for all associated wireless clients. If 802.1x authentication is not initiated by a client, the BSAP-1600 will initiate authentication. Only those clients successfully authenticated with 802.1x are allowed to access the network.

Note: If 802.1x is enabled on the BSAP-1600, then RADIUS setup must be completed (RADIUS).

When 802.1x is enabled, the broadcast and session key rotation intervals can also be configured.

- **Broadcast Key Refresh Rate:** Sets the interval at which the broadcast keys are refreshed for stations using 802.1x dynamic keying. (Range: 0-1440 minutes; Default: 0 means disabled)
- **Session Key Refresh Rate:** The interval at which the BSAP-1600 refreshes unicast session keys for associated clients. (Range: 0-1440 minutes; Default: 0 means disabled)
- **802.1x Reauthentication Refresh Rate:** The time period after which a connected client must be re-authenticated. During the re-authentication process of verifying the client's credentials on the RADIUS server, the client remains connected the network. Only if re-authentication fails is network access blocked. (Range: 0-65535 seconds; Default: 0 means disabled)

CLI Commands for *802.1x Authentication* – Use the **802.1x supported** command from the VAP (Virtual Access Point) interface mode to enable 802.1x authentication. Set the session and broadcast key refresh rate, and the re-authentication timeout. To display the current settings, use the **show interface wireless** command from the Exec mode (not shown in the example).

```

Enterprise AP(if-wireless g: VAP[0])#802.1x supported                6-66
Enterprise AP(if-wireless g: VAP[0])#802.1x broadcast-key-refresh-rate 5 6-67
Enterprise AP(if-wireless g: VAP[0])#802.1x session-key-refresh-rate 5    6-68
Enterprise AP(if-wireless g: VAP[0])#802.1x session-timeout 300          6-68
Enterprise AP#
    
```

Status Information

The Status page includes information on the following items:

Table 6-8: Status page

Menu	Description	Page
AP Status	Displays configuration settings for the basic system and the wireless interface	6-75
Station Status	Shows the wireless clients currently associated with the BSAP-1600	6-77
Event Logs	Shows log messages stored in memory	6-79

Access Point Status

The AP Status window displays basic system configuration settings, as well as the settings for the wireless interface.

AP Status

AP System Configuration

Serial Number	
System Up Time	0 days, 5 hours, 35 minutes, 22 seconds
Ethernet MAC Address	00-12-CF-12-34-60
Radio A MAC Address	00-12-CF-12-34-61
Radio G MAC Address	00-12-CF-12-34-65
System Name	R&D
System Contact	Contact
IP Address	192.168.1.1
IP default-gateway	0.0.0.0
HTTP Server	ENABLED
HTTP Server Port	80
Software Version	v4.3.2.0b01
BootRom Version	v1.1.5
Hardware Version	R03

AP Wireless Configuration

Interface Wireless A

VAP 0 SSID	VAP_TEST_11A 0
VAP 1 SSID	VAP_TEST_11A 1
VAP 2 SSID	VAP_TEST_11A 2
VAP 3 SSID	VAP_TEST_11A 3
Radio a Channel	56

AP System Configuration – The AP System Configuration table displays the basic system configuration settings:

- System Up Time: Length of time the management agent has been up.
- Ethernet MAC: The physical layer address for the Ethernet port.
- Radio A MAC: The physical layer address for the 802.11a interface.
- Radio G MAC: The physical layer address for the 802.11b/g interface.
- System Name: Name assigned to this system.
- System Contact: Administrator responsible for the system.
- IP Address: IP address of the management interface for this device.
- IP Default Gateway: IP address of the gateway router between this device and management stations that exist on other network segments.
- HTTP Server: Shows if management access via HTTP is enabled.
- HTTP Server Port: Shows the TCP port used by the HTTP interface.
- Software Version: Shows the software version number.
- Bootrom Version: Show the bootrom version number.
- Hardware Version: Shows the hardware version number.

AP Wireless Configuration – The AP Wireless Configuration tables display the radio and VAP (Virtual Access Point) interface settings listed below. Note that

Interface Wireless A refers to the 802.11a radio and Interface Wireless G refers to the 802.11b/g radio.

- SSID: The service set identifier for the VAP (Virtual Access Point) interface.
- Radio Channel: The radio channel through which the BSAP-1600 communicates with wireless clients.
- Encryption: The key size used for data encryption.
- Authentication Type: Shows the type of authentication used.
- 802.1x: Shows if IEEE 802.1x access control for wireless clients is enabled.

CLI Commands for Displaying System Settings – To view the current BSAP-1600 system settings, use the **show system** command from the Exec mode. To view the current radio interface settings, use the **show interface wireless a** or **show interface wireless g** command (see “show interface wireless” on page 7-91).

```

Enterprise AP#show system                                     6-24
System Information
=====
Serial Number       : A123456789
System Up time     : 0 days, 4 hours, 33 minutes, 29 seconds
System Name        : Enterprise Wireless AP
System Location    :
System Contact     :
System Country Code : US - UNITED STATES
MAC Address        : 00-30-F1-F0-9A-9C
IP Address         : 192.168.1.1
Subnet Mask        : 255.255.255.0
Default Gateway    : 0.0.0.0
VLAN State         : DISABLED
Management VLAN ID(AP) : 1
IAPP State         : ENABLED
DHCP Client        : ENABLED
HTTP Server        : ENABLED
HTTP Server Port   : 80
HTTPS Server       : ENABLED
HTTPS Server Port  : 443
Slot Status        : Dual band(a/g)
Boot Rom Version   : v3.0.7
Software Version   : v3.0.0.1
SSH Server         : ENABLED
SSH Server Port    : 22
Telnet Server      : ENABLED
WEB Redirect       : DISABLED
DHCP Relay         : DISABLED
=====
Enterprise AP#

```

Station Status

The Station Status window shows the wireless clients currently associated with the BSAP-1600.

☰ Interface G

VAP 0

802.11g Station				
Station Address	Authenticated	Associated	Forwarding Allowed	Key Type

VAP 1

802.11g Station				
Station Address	Authenticated	Associated	Forwarding Allowed	Key Type

VAP 2

802.11g Station				
Station Address	Authenticated	Associated	Forwarding Allowed	Key Type

VAP 3

802.11g Station				
Station Address	Authenticated	Associated	Forwarding Allowed	Key Type

The Station Configuration page displays basic connection information for all associated stations as described below. Note that this page is automatically refreshed every five seconds.

- Station Address: The MAC address of the wireless client.
- Authenticated: Shows if the station has been authenticated. The two basic methods of authentication supported for 802.11 wireless networks are “open system” and “shared key.” Open-system authentication accepts any client attempting to connect to the BSAP-1600 without verifying its identity. The shared-key approach uses Wired Equivalent Privacy (WEP) to verify client identity by distributing a shared key to stations before attempting authentication.
- Associated: Shows if the station has been successfully associated with the BSAP-1600. Once authentication is completed, stations can associate with the current BSAP-1600, or reassociate with a new BSAP-1600. The association procedure allows the wireless system to track the location of each mobile client, and ensure that frames destined for each client are forwarded to the appropriate BSAP-1600.
- Forwarding Allowed: Shows if the station has passed 802.1x authentication and is now allowed to forward traffic to the BSAP-1600.
- Key Type – Displays one of the following:
 - WEP Disabled – The client is not using Wired Equivalent Privacy (WEP) encryption keys.
 - Dynamic – The client is using Wi-Fi Protected Access (802.1x or pre-shared key mode) or using 802.1x authentication with dynamic keying.
 - Static – The client is using static WEP keys for encryption.

CLI Commands for Displaying Station Status – To view status of clients currently associated with the BSAP-1600, use the **show station** command from the Exec mode.

```

Enterprise AP#show station 6-114

Station Table Information
=====
if-wireless A VAP [0]   :
802.11a Channel : Auto

No 802.11a Channel Stations.

if-wireless A VAP [1]   :
802.11a Channel : Auto

No 802.11a Channel Stations.

....

No 802.11a Channel Stations.

if-wireless A VAP [3]   :
802.11a Channel : Auto

No 802.11a Channel Stations.

if-wireless G VAP [0]   :
802.11g Channel : Auto

No 802.11g Channel Stations.

if-wireless G VAP [1]   :
802.11g Channel : Auto

No 802.11g Channel Stations.

....

No 802.11g Channel Stations.

if-wireless G VAP [3]   :
802.11g Channel : Auto

No 802.11g Channel Stations.
=====
Enterprise AP#
    
```

Event Logs

The Event Logs window shows the log messages generated by the BSAP-1600 and stored in memory.

Event Logs	
1	Jan 01 06:11:49 Debug: Request timeout (type=WAITING_ACCOUNTING_ON_MSG) on Accounting Server(0)
2	Jan 01 06:11:44 Debug: Request timeout (type=WAITING_ACCOUNTING_ON_MSG) on Accounting Server(1)
3	Jan 01 06:11:44 Debug: Request timeout (type=WAITING_ACCOUNTING_ON_MSG) on Accounting Server(0)
4	Jan 01 06:11:39 Debug: Request timeout (type=WAITING_ACCOUNTING_ON_MSG) on Accounting Server(1)
5	Jan 01 06:11:39 Debug: Request timeout (type=WAITING_ACCOUNTING_ON_MSG) on Accounting Server(0)
6	Jan 01 06:11:34 Debug: Request timeout (type=WAITING_ACCOUNTING_ON_MSG) on Accounting Server(1)

The Event Logs table displays the following information:

- Log Time: The time the log message was generated.

- Event Level: The logging level associated with this message. For a description of the various levels, see “System Log ” on page 6-28.
- Event Message: The content of the log message.

Error Messages – An example of a logged error message is: “Station Failed to authenticate (unsupported algorithm).”

This message may be caused by any of the following conditions:

- BSAP-1600 was set to “Open Authentication”, but a client sent an authentication request frame with a “Shared key.”
- BSAP-1600 was set to “Shared Key Authentication,” but a client sent an authentication frame for “Open System.”
- WEP keys do not match: When the BSAP-1600 uses “Shared Key Authentication,” but the key used by client and BSAP-1600 are not the same, the frame will be decrypted incorrectly, using the wrong algorithm and sequence number.

CLI Commands for *Displaying the Logging Status* – From the global configuration mode, use the **show logging** command.

```
Enterprise AP#show logging 6-33

Logging Information
=====
Syslog State           : Enabled
Logging Console State  : Enabled
Logging Level          : Alert
Logging Facility Type  : 16
Servers
  1: 192.168.1.19, UDP Port: 514, State: Enabled
  2: 0.0.0.0, UDP Port: 514, State: Disabled
  3: 0.0.0.0, UDP Port: 514, State: Disabled
  4: 0.0.0.0, UDP Port: 514, State: Disabled
=====
Enterprise AP#
```

CLI Commands for *Displaying Event Logs* – To view the BSAP-1600 log entries, use the **show event-log** command from the Exec mode. To clear all log entries from the BSAP-1600, use the **logging clear** command from the Global Configuration mode.

```
Enterprise AP#show event-log 6-34
Mar 09 11:57:55 Information: 802.11g:11g Radio Interface Enabled
Mar 09 11:57:55 Information: 802.11g:Radio channel updated to 8
Mar 09 11:57:34 Information: 802.11g:11g Radio Interface Enabled
Mar 09 11:57:18 Information: 802.11g:11g Radio Interface Enabled
Mar 09 11:56:35 Information: 802.11a:11a Radio Interface Enabled
Mar 09 11:55:52 Information: SSH task: Set SSH server port to 22
Mar 09 11:55:52 Information: SSH task: Enable SSH server.
Mar 09 11:55:52 Information: Enable Telnet.
Mar 09 11:55:40 Information: 802.11a:11a Radio Interface Disabled
Mar 09 11:55:40 Information: 802.11a:Transmit Power set to QUARTER
Press <n> next. <p> previous. <a> abort. <y> continue to end :
Enterprise AP#configure
Enter configuration commands, one per line. End with CTRL/Z
Enterprise AP(config)#logging clear 6-33
Enterprise AP#
```

STP Status

The STP Status window shows the STP status for each port.

STP information

Port Summary

Id	Priority	Path Cost	Status	State
1	128	19	Enable	Forwarding
18	128	19	Enable	Forwarding
19	128	19	Enable	Forwarding
20	128	19	Enable	Forwarding
21	128	19	Enable	Forwarding
22	128	19	Enable	Forwarding
23	128	19	Enable	Forwarding
24	128	19	Enable	Forwarding
25	128	19	Enable	Forwarding
26	128	19	Enable	Forwarding
27	128	19	Enable	Forwarding
28	128	19	Enable	Forwarding
29	128	19	Enable	Forwarding

- ID: Displays the port ID number.
 - Priority: The priority designated to the specified port.
 - Path Cost: Displays the path cost value for the specified port.
 - Status: Displays if STP is enabled or disabled for the specified port.
- State: Display the STP state for the specified port.

7)))

Command Line Interface

Using the Command Line Interface

Accessing the CLI

When accessing the management interface for the BSAP-1600 over a direct connection to the console port, or via a Telnet connection, the BSAP-1600 can be managed by entering command keywords and parameters at the prompt. Using the BSAP-1600's command-line interface (CLI) is very similar to entering commands on a UNIX system.

Console Connection

To access the BSAP-1600 through the console port, perform these steps:

1. At the console prompt, enter the user name and password. (The default user name is "admin" and the default password is "smcadmin") When the user name is entered, the CLI displays the "Enterprise AP#" prompt.
2. Enter the necessary commands to complete your desired tasks.
3. When finished, exit the session with the "exit" command.

After connecting to the system through the console port, the login screen displays:

```
Username: admin
Password:
Enterprise AP#
```

Note: Command examples shown later in this chapter abbreviate the console prompt to "AP" for simplicity.

Telnet Connection

Telnet operates over the IP transport protocol. In this environment, your management station and any network device you want to manage over the network must have a valid IP address. Valid IP addresses consist of four numbers, 0 to 255, separated by periods. Each address consists of a network portion and host portion. For example, if the BSAP-1600 cannot acquire an IP address from a DHCP server, the default IP address used by the BSAP-1600, 192.168.1.1, consists of a network portion (192.168.1) and a host portion (1).

To access the BSAP-1600 through a Telnet session, you must first set the IP address for the BSAP-1600, and set the default gateway if you are managing the BSAP-1600 from a different IP subnet. For example:

```
Enterprise AP#configure
Enterprise AP(config)#interface ethernet
Enterprise AP(if-ethernet)#ip address 10.1.0.1 255.255.255.0
10.1.0.254
Enterprise AP(if-ethernet)#
```

If your corporate network is connected to another network outside your office or to the Internet, you need to apply for a registered IP address. However, if you are attached to an isolated network, then you can use any IP address that matches the network segment to which you are attached.

After you configure the BSAP-1600 with an IP address, you can open a Telnet session by performing these steps.

1. From the remote host, enter the Telnet command and the IP address of the device you want to access.
2. At the prompt, enter the user name and system password. The CLI will display the "Enterprise AP#" prompt to show that you are using executive access mode (i.e., Exec).
3. Enter the necessary commands to complete your desired tasks.
4. When finished, exit the session with the "quit" or "exit" command.

After entering the Telnet command, the login screen displays:

```
Username: admin
Password:
Enterprise AP#
```

Note: You can open up to four sessions to the device via Telnet.

Entering Commands

This section describes how to enter CLI commands.

Keywords and Arguments

A CLI command is a series of keywords and arguments. Keywords identify a command, and arguments specify configuration parameters. For example, in the command "show interfaces ethernet," **show** and **interfaces** are keywords, and **ethernet** is an argument that specifies the interface type.

You can enter commands as follows:

- To enter a simple command, enter the command keyword.
- To enter commands that require parameters, enter the required parameters after the command keyword. For example, to set a password for the administrator, enter:

```
Enterprise AP(config)#username smith
```

Minimum Abbreviation

The CLI will accept a minimum number of characters that uniquely identify a command. For example, the command "configure" can be entered as **con**. If an entry is ambiguous, the system will prompt for further input.

Command Completion

If you terminate input with a Tab key, the CLI will print the remaining characters of a partial keyword up to the point of ambiguity. In the “configure” example, typing `con` followed by a tab will result in printing the command up to “`configure`.”

Getting Help on Commands

You can display a brief description of the help system by entering the `help` command. You can also display command syntax by following a command with the “?” character to list keywords or parameters.

Showing Commands

If you enter a “?” at the command prompt, the system will display the first level of keywords for the current configuration mode (Exec, Global Configuration, or Interface). You can also display a list of valid keywords for a specific command. For example, the command “`show ?`” displays a list of possible show commands:

```
Enterprise AP#show ?
  APmanagement  Show management AP information.
  authentication Show Authentication parameters
  bootfile       Show bootfile name
  bridge         Show bridge
  config         System snapshot for tech support
  dhcp-relay     Show DHCP Relay Configuration
  event-log      Show event log on console
  filters        Show filters
  hardware       Show hardware version
  history        Display the session history
  interface      Show interface information
  line           TTY line information
  link-integrity Show link integrity information
  logging        Show the logging buffers
  radius         Show radius server
  rogue-ap       Show Rogue ap Stations
  snmp           Show snmp configuration
  sntp           Show sntp configuration
  station        Show 802.11 station table
  system         Show system information
  version        Show system version
Enterprise AP#show
```

The command “`show interface ?`” will display the following information:

```
Enterprise AP#show interface ?
  ethernet Show Ethernet interface
  wireless Show wireless interface
  <cr>
Enterprise AP#show interface
```

Partial Keyword Lookup

If you terminate a partial keyword with a question mark, alternatives that match the initial letters are provided. (Remember not to leave a space between the command and question mark.) For example “`s?`” shows all the keywords starting with “s.”

```
Enterprise AP#show s?
snmp      sntp      station  system
Enterprise AP#show s
```

Negating the Effect of Commands

For many configuration commands you can enter the prefix keyword “no” to cancel the effect of a command or reset the configuration to the default value. For example, the **logging** command will log system messages to a host server. To disable logging, specify the **no logging** command. This guide describes the negation effect for all applicable commands.

Using Command History

The CLI maintains a history of commands that have been entered. You can scroll back through the history of commands by pressing the up arrow key. Any command displayed in the history list can be executed again, or first modified and then executed.

Using the **show history** command displays a longer list of recently executed commands.

Understanding Command Modes

The command set is divided into Exec and Configuration classes. Exec commands generally display information on system status or clear statistical counters. Configuration commands, on the other hand, modify interface parameters or enable certain functions. These classes are further divided into different modes. Available commands depend on the selected mode. You can always enter a question mark “?” at the prompt to display a list of the commands available for the current mode. The command classes and associated modes are displayed in the following table:

Table 7-1: Command Classes and Associated Modes

Class	Mode
Exec	Privileged
Configuration	Global Interface-ethernet Interface-wireless Interface-wireless-vap

Exec Commands

When you open a new console session on an BSAP-1600, the system enters Exec command mode. Only a limited number of the commands are available in this mode. You can access all other commands only from the configuration mode. To access Exec mode, open a new console session with the user name “admin.” The command prompt displays as “Enterprise AP#” for Exec mode.

```
Username: admin
Password: [system login password]
Enterprise AP#
```

Configuration Commands

Configuration commands are used to modify BSAP-1600 settings. These commands modify the running configuration and are saved in memory.

The configuration commands are organized into four different modes:

- Global Configuration (GC) - These commands modify the system level configuration, and include commands such as **username** and **password**.

- Interface-Ethernet Configuration (IC-E) - These commands modify the Ethernet port configuration, and include command such as **dns** and **ip**.
- Interface-Wireless Configuration (IC-W) - These commands modify the wireless port configuration of global parameters for the radio, and include commands such as **channel** and **transmit-power**.
- Interface-Wireless Virtual Access Point Configuration (IC-W-VAP) - These commands modify the wireless port configuration for each VAP, and include commands such as **ssid** and **authentication**.

To enter the Global Configuration mode, enter the command **configure** in Exec mode. The system prompt will change to "Enterprise AP(config)#" which gives you access privilege to all Global Configuration commands.

```
Enterprise AP#configure
Enterprise AP(config)#
```

To enter Interface mode, you must enter the "interface ethernet," or "interface wireless a," or "interface wireless g" command while in Global Configuration mode. The system prompt will change to "Enterprise AP(if-ethernet)#," or Enterprise AP(if-wireless)" indicating that you have access privileges to the associated commands. You can use the **end** command to return to the Exec mode.

```
Enterprise AP(config)#interface ethernet
Enterprise AP(if-ethernet)#
```

Command Line Processing

Commands are not case sensitive. You can abbreviate commands and parameters as long as they contain enough letters to differentiate them from any other currently available commands or parameters. You can use the Tab key to complete partial commands, or enter a partial command followed by the "?" character to display a list of possible matches. You can also use the following editing keystrokes for command-line processing:

Table 7-2: Keystroke Commands

Keystroke	Function
Ctrl-A	Shifts cursor to start of command line.
Ctrl-B	Shifts cursor to the left one character.
Ctrl-C	Terminates a task and displays the command prompt.
Ctrl-E	Shifts cursor to end of command line.
Ctrl-F	Shifts cursor to the right one character.
Ctrl-K	Deletes from cursor to the end of the command line.
Ctrl-L	Repeats current command line on a new line.
Ctrl-N	Enters the next command line in the history buffer.
Ctrl-P	Shows the last command.
Ctrl-R	Repeats current command line on a new line.
Ctrl-U	Deletes the entire line.
Ctrl-W	Deletes the last word typed.

Table 7-2: Keystroke Commands

Esc-B	Moves the cursor backward one word.
Esc-D	Deletes from the cursor to the end of the word.
Esc-F	Moves the cursor forward one word.
Delete or backspace key	Erases a mistake when entering a command.

Command Groups

The system commands can be broken down into the functional groups shown below.

Table 7-3: Command Groups

Command Group	Description	Page
General	Basic commands for entering configuration mode, restarting the system, or quitting the CLI	7-7
System Management	Controls user name, password, web browser management options, and a variety of other system information	7-10
System Logging	Configures system logging parameters	7-26
System Clock	Configures SNTP and system clock settings	7-30
DHCP Relay	Configures the BSAP-1600 to send DHCP requests from clients to specified servers	7-33
SNMP	Configures community access strings and trap managers	7-35
Flash/File	Manages code image or BSAP-1600 configuration files	7-47
RADIUS	Configures the RADIUS client used with 802.1X authentication	7-50
802.1X Authentication	Configures 802.1X authentication	7-55
MAC Address Authentication	Configures MAC address authentication	7-59
Filtering	Filters communications between wireless clients, controls access to the management interface from wireless clients, and filters traffic using specific Ethernet protocol types	7-62
WDS Bridge	Configures WDS forwarding table settings	7-65
Spanning Tree	Configures spanning tree parameters	7-71
Ethernet Interface	Configures connection parameters for the Ethernet interface	7-75
Wireless Interface	Configures radio interface settings	7-79

Table 7-3: Command Groups

Wireless Security	Configures radio interface security and encryption settings	7-95
Rogue AP Detection	Configures settings for the detection of rogue access points in the network	7-98
Link Integrity	Configures a link check to a host device on the wired network	7-106
IAPP	Enables roaming between multi-vendor access points	7-109
VLANs	Configures VLAN membership	7-110
WMM	Configures WMM quality of service parameters	7-112

The access mode shown in the following tables is indicated by these abbreviations: **Exec** (Executive Mode), **GC** (Global Configuration), **IC-E** (Interface-Ethernet Configuration), **IC-W** (Interface-Wireless Configuration), and **IC-W-VAP** (Interface-Wireless VAP Configuration).

General Commands

Table 7-4: General Commands

Command	Function	Mode	Page
configure	Activates global configuration mode	Exec	7-7
end	Returns to previous configuration mode	GC, IC	7-8
exit	Returns to the previous configuration mode, or exits the CLI	any	7-8
ping	Sends ICMP echo request packets to another node on the network	Exec	7-8
reset	Restarts the system	Exec	7-9
show history	Shows the command history buffer	Exec	7-9
show line	Shows the configuration settings for the console port	Exec	7-10

configure

This command activates Global Configuration mode. You must enter this mode to modify most of the settings on the BSAP-1600. You must also enter Global Configuration mode prior to enabling the context modes for Interface Configuration. Using the Command Line Interface

Default Setting None

Command Mode Exec

Example

```
Enterprise AP#configure
Enterprise AP(config)#
```

**Related
Commands**

end

end

This command returns to the previous configuration mode.

Default Setting

None

**Command
Mode**

Global Configuration, Interface Configuration

Example

This example shows how to return to the Configuration mode from the Interface Configuration mode:

```
Enterprise AP(if-ethernet)#end
Enterprise AP(config)#
```

exit

This command returns to the Exec mode or exits the configuration program.

Default Setting

None

**Command
Mode**

Any

Example

This example shows how to return to the Exec mode from the Interface Configuration mode, and then quit the CLI session:

```
Enterprise AP(if-ethernet)#exit
Enterprise AP#exit
CLI session with the Access Point is now closed

Username:
```

ping

This command sends ICMP echo request packets to another node on the network.

Syntax

ping <host_name / ip_address>

- *host_name* - Alias of the host.
- *ip_address* - IP address of the host.

Default Setting

None

**Command
Mode**

Exec

**Command
Usage**

- Use the ping command to see if another site on the network can be reached.

- The following are some results of the **ping** command:
 - *Normal response* - The normal response occurs in one to ten seconds, depending on network traffic.
 - *Destination does not respond* - If the host does not respond, a “timeout” appears in ten seconds.
 - *Destination unreachable* - The gateway for this destination indicates that the destination is unreachable.
 - *Network or host unreachable* - The gateway found no corresponding entry in the route table.
- Press <Esc> to stop pinging.

Example

```
Enterprise AP#ping 10.1.0.19
192.168.1.19 is alive
Enterprise AP#
```

reset

This command restarts the system or restores the factory default settings.

Syntax `reset <board | configuration>`

- **board** - Reboots the system.
- **configuration** - Resets the configuration settings to the factory defaults, and then reboots the system.

Default Setting None

Command Mode Exec

Command Usage When the system is restarted, it will always run the Power-On Self-Test.

Example This example shows how to reset the system:

```
Enterprise AP#reset board
Reboot system now? <y/n>: y
```

show history

This command shows the contents of the command history buffer.

Default Setting None

Command Mode Exec

Command Usage

- The history buffer size is fixed at 10 commands.
- Use the up or down arrow keys to scroll through the commands in the history buffer.

Example In this example, the show history command lists the contents of the command history buffer:

```
Enterprise AP#show history
config
exit
show history
Enterprise AP#
```

show line

This command displays the console port's configuration settings.

Command Mode Exec

Example The console port settings are fixed at the values shown below.

```
Enterprise AP#show line
Console Line Information
=====
 databits   : 8
 parity     : none
 speed      : 9600
 stop bits  : 1
=====
Enterprise AP#
```

System Management Commands

These commands are used to configure the user name, password, system logs, browser management options, clock settings, and a variety of other system information.

Table 7-5: System Management Commands

Command	Function	Mode	Page
Country Setting			
country	Sets the BSAP-1600 country code	Exec	7-11
Device Designation			
prompt	Customizes the command line prompt	GC	7-13
system name	Specifies the host name for the BSAP-1600	GC	7-13
snmp-server contact	Sets the system contact string	GC	
snmp-server location	Sets the system location string	GC	
Management Access			
username	Configures the user name for management access	GC	7-14

Table 7-5: System Management Commands

password	Specifies the password for management access	GC	7-14
ip ssh-server enable	Enables the Secure Shell server	IC-E	7-14
ip ssh-server port	Sets the Secure Shell port	IC-E	7-15
ip telnet-server enable	Enables the Telnet server	IC-E	7-15
APmgmtIP	Specifies an IP address or range of addresses allowed access to the management interface	GC	7-18
APmgmtUI	Enables or disables SNMP, Telnet or web management access	GC	7-19
show APmanagement	Shows the AP management configuration	Exec	7-20
Web Server			
ip http port	Specifies the port to be used by the web browser interface	GC	7-16
ip http server	Allows the BSAP-1600 to be monitored or configured from a browser	GC	7-16
ip http session-timeout	Sets the timeout for the web browser interface	GC	7-16
ip https port	Specifies the UDP port number used for a secure HTTP connection to the BSAP-1600's Web interface	GC	7-17
ip https server	Enables the secure HTTP server on the BSAP-1600	GC	7-17
web-redirect	Enables web authentication of clients using a public access Internet service	GC	7-18
System Status			
show system	Displays system information	Exec	7-20
show version	Displays version information for the system	Exec	7-21
show config	Displays detailed configuration information for the system	Exec	7-22
show hardware	Displays the BSAP-1600's hardware version	Exec	7-26

country

This command configures the BSAP-1600's country code, which identifies the country of operation and sets the authorized radio channels.

Syntax `country <country_code>`

country_code - A two character code that identifies the country of operation. See the following table for a full list of codes.

Table 7-6: Country Codes

Country	Code	Country	Code	Country	Code	Country	Code
Albania	AL	Dominican Republic	DO	Kuwait	KW	Romania	RO
Algeria	DZ	Ecuador	EC	Latvia	LV	Russia	RU
Argentina	AR	Egypt	EG	Lebanon	LB	Saudi Arabia	SA
Armenia	AM	Estonia	EE	Liechtenstein	LI	Singapore	SG
Australia	AU	Finland	FI	Lithuania	LT	Slovak Republic	SK
Austria	AT	France	FR	Macao	MO	Spain	ES
Azerbaijan	AZ	Georgia	GE	Macedonia	MK	Sweden	SE
Bahrain	BH	Germany	DE	Malaysia	MY	Switzerland	CH
Belarus	BY	Greece	GR	Malta	MT	Syria	SY
Belgium	BE	Guatemala	GT	Mexico	MX	Taiwan	TW
		Honduras	HN	Monaco	MC	Thailand	TH
Belize	BZ	Hong Kong	HK	Morocco	MA	Trinidad & Tobago	TT
Bolivia	BO	Hungary	HU	Netherlands	NL	Tunisia	TN
Brazil	BR	Iceland	IS	New Zealand	NZ	Turkey	TR
Brunei Darussalam	BN	India	IN	Norway	NO	Ukraine	UA
Bulgaria	BG	Indonesia	ID	Qatar	QA	United Arab Emirates	AE
Canada	CA	Iran	IR	Oman	OM	United Kingdom	GB
Chile	CL	Ireland	IE	Pakistan	PK	United States	US
China	CN	Israel	IL	Panama	PA	Uruguay	UY
Colombia	CO	Italy	IT	Peru	PE	Uzbekistan	UZ
Costa Rica	CR	Japan	JP	Philippines	PH	Yemen	YE
Croatia	HR	Jordan	JO	Poland	PL	Venezuela	VE
Cyprus	CY	Kazakhstan	KZ	Portugal	PT	Vietnam	VN

Table 7-6: Country Codes

Czech Republic	CZ	North Korea	KP	Puerto Rico	PR	Zimbabwe	ZW
Denmark	DK	Korea Republic	KR	Slovenia	SI		
Elsalvador	SV	Luxembourg	LU	South Africa	ZA		

Default Setting US - for BSAP-1600s sold in the United States
99 (no country set) - for BSAP-1600s sold in other countries

Command Mode Exec

Command Usage

- If you purchased an BSAP-1600 outside of the United States, the country code must be set before radio functions are enabled.
- The available Country Code settings can be displayed by using the **country ?** command.

Example

```
Enterprise AP#country tw
Enterprise AP#
```

prompt

This command customizes the CLI prompt. Use the **no** form to restore the default prompt.

Syntax **prompt** <string>
no prompt

string - Any alphanumeric string to use for the CLI prompt. (Maximum length: 32 characters)

Default Setting Enterprise AP

Command Mode Global Configuration

Example

```
Enterprise AP(config)#prompt RD2
RD2(config)#
```

system name

This command specifies or modifies the system name for this device. Use the **no** form to restore the default system name.

Syntax **system name** <name>
no system name

name - The name of this host.
(Maximum length: 32 characters)

Default Setting Enterprise AP

Command Mode Global Configuration

Example

```
Enterprise AP(config)#system name AP
Enterprise AP(config)#
```

username

This command configures the user name for management access.

Syntax `username <name>`

name - The name of the user.
(Length: 3-16 characters, case sensitive)

Default Setting admin

Command Mode Global Configuration

Example

```
Enterprise AP(config)#username bob
Enterprise AP(config)#
```

password

After initially logging onto the system, you should set the password. Remember to record it in a safe place. Use the **no** form to reset the default password.

Syntax `password <password>`
`no password`

password - Password for management access.
(Length: 3-16 characters, case sensitive)

Default Setting smcadmin

Command Mode Global Configuration

Example

```
Enterprise AP(config)#password
Enterprise AP(config)#
```

ip ssh-server enable

This command enables the Secure Shell server. Use the **no** form to disable the server.

- Syntax** ip ssh-server enable
no ip ssh-server
- Default Setting** Interface enabled
- Command Mode** Interface Configuration (Ethernet)
- Command Usage**
- The BSAP-1600 supports Secure Shell version 2.0 only.
 - After boot up, the SSH server needs about two minutes to generate host encryption keys. The SSH server is disabled while the keys are being generated. The **show system** command displays the status of the SSH server.

Example

```
Enterprise AP(if-ethernet)#ip ssh-server enable
Enterprise AP(if-ethernet)#
```

ip ssh-server port

This command sets the Secure Shell server port. Use the **no** form to disable the server.

- Syntax** ip ssh-server port <port-number>
- *port-number* - The UDP port used by the SSH server. (Range: 1-65535)
- Default Setting** 22
- Command Mode** Interface Configuration (Ethernet)
- Example**

```
Enterprise AP(if-ethernet)#ip ssh-server port 1124
Enterprise AP(if-ethernet)#
```

ip telnet-server enable

This command enables the Telnet server. Use the **no** form to disable the server.

- Syntax** ip telnet-server enable
no ip telnet-server
- Default Setting** Interface enabled
- Command Mode** Interface Configuration (Ethernet)
- Example**

```
Enterprise AP(if-ethernet)#ip telnet-server enable
Enterprise AP(if-ethernet)#
```

ip http port

This command specifies the TCP port number used by the web browser interface. Use the **no** form to use the default port.

Syntax `ip http port <port-number>`
`no ip http port`

port-number - The TCP port to be used by the browser interface. (Range: 1024-65535)

Default Setting 80

Command Mode Global Configuration

Example

```
Enterprise AP(config)#ip http port 769
Enterprise AP(config)#
```

Related Commands `ip http server`

ip http server

This command allows this device to be monitored or configured from a browser. Use the **no** form to disable this function.

Syntax `ip http server`
`no ip http server`

Default Setting Enabled

Command Mode Global Configuration

Example

```
Enterprise AP(config)#ip http server
Enterprise AP(config)#
```

Related Commands `ip http port`

ip http session-timeout

This command sets the time limit for an idle web interface session.

Syntax `ip http session-timeout <time>`
time - Sets the web interface session timeout.
(Range: 0 - 1800 seconds, 0 means disabled)

Default Setting 300 seconds

Command Mode Global Configuration

Example

```
Enterprise AP(config)#ip http session-timeout 0
Enterprise AP(config)#
```

Related Commands ip http port

ip https port

Use this command to specify the UDP port number used for HTTPS/SSL connection to the BSAP-1600's Web interface. Use the **no** form to restore the default port.

Syntax ip https port <port_number>
no ip https port

port_number – The UDP port used for HTTPS/SSL.
(Range: 80, 1024-65535)

Default Setting 443

Command Mode Global Configuration

Command Usage

- You cannot configure the HTTP and HTTPS servers to use the same port.
- To avoid using common reserved TCP port numbers below 1024, the configurable range is restricted to 443 and between 1024 and 65535.
- If you change the HTTPS port number, clients attempting to connect to the HTTPS server must specify the port number in the URL, in this format:
https://device:port_number

Example

```
Enterprise AP(config)#ip https port 1234
Enterprise AP(config)#
```

ip https server

Use this command to enable the secure hypertext transfer protocol (HTTPS) over the Secure Socket Layer (SSL), providing secure access (i.e., an encrypted connection) to the BSAP-1600's Web interface. Use the **no** form to disable this function.

Syntax ip https server
no ip https server

Default Setting Enabled

Command Mode Global Configuration

Command Usage

- Both HTTP and HTTPS service can be enabled independently.
- If you enable HTTPS, you must indicate this in the URL:
https://device:port_number]
- When you start HTTPS, the connection is established in this way:
 - The client authenticates the server using the server's digital certificate.
 - The client and server negotiate a set of security protocols to use for the connection.
 - The client and server generate session keys for encrypting and decrypting data.

- The client and server establish a secure encrypted connection. A padlock icon should appear in the status bar for Internet Explorer 5.x.

Example

```
Enterprise AP(config)#ip https server
Enterprise AP(config)#
```

web-redirect

Use this command to enable web-based authentication of clients. Use the **no** form to disable this function.

Syntax [no] web-redirect

Default Setting Disabled

Command Mode Global Configuration

- Command Usage**
- The web redirect feature is used to support billing for a public access wireless network. After successful association to an BSAP-1600, a client is “redirected” to an BSAP-1600 login web page as soon as Internet access is attempted. The client is then authenticated by entering a user name and password on the web page. This process allows controlled access for clients without requiring 802.1X or MAC authentication.
 - Web redirect requires a RADIUS server on the wired network with configured user names and passwords for authentication. The RADIUS server details must also be configured on the BSAP-1600. (See “show bootfile” on page 7-50.)
 - Use the **show system** command to display the current web redirect status.

Example

```
Enterprise AP(config)#web-redirect
Enterprise AP(config)#
```

APmgmtIP

This command specifies the client IP addresses that are allowed management access to the BSAP-1600 through various protocols.

Note: Secure Web (HTTPS) connections are not affected by the UI Management or IP Management settings.

Syntax APmgmtIP <multiple *IP_address subnet_mask* | single *IP_address* | any>

- **multiple** - Adds IP addresses within a specifiable range to the SNMP, web and Telnet groups.
- **single** - Adds an IP address to the SNMP, web and Telnet groups.
- **any** - Allows any IP address access through SNMP, web and Telnet groups.
- *IP_address* - Adds IP addresses to the SNMP, web and Telnet groups.
- *subnet_mask* - Specifies a range of IP addresses allowed management access.

Default Setting All addresses

Command Mode Global Configuration

- Command Usage**
- If anyone tries to access a management interface on the BSAP-1600 from an invalid address, the BSAP-1600 will reject the connection, enter an event message in the system log, and send a trap message to the trap manager.
 - IP address can be configured for SNMP, web and Telnet access respectively. Each of these groups can include up to five different sets of addresses, either individual addresses or address ranges.
 - When entering addresses for the same group (i.e., SNMP, web or Telnet), the BSAP-1600 will not accept overlapping address ranges. When entering addresses for different groups, the BSAP-1600 will accept overlapping address ranges.
 - You cannot delete an individual address from a specified range. You must delete the entire range, and reenter the addresses.
 - You can delete an address range just by specifying the start address, or by specifying both the start address and end address.

Example This example restricts management access to the indicated addresses.

```
Enterprise AP(config)#apmgmtip multiple 192.168.1.50
255.255.255.0
Enterprise AP(config)#
```

APmgmtUI

This command enables and disables management access to the BSAP-1600 through SNMP, Telnet and web interfaces.

Note: Secure Web (HTTPS) connections are not affected by the UI Management or IP Management settings.

- Syntax** APmgmtUI <[SNMP | Telnet | Web] enable | disable>
- **SNMP** - Specifies SNMP management access.
 - **Telnet** - Specifies Telnet management access.
 - **Web** - Specifies web based management access.
 - **enable/disable** - Enables or disables the selected management access method.

Default Setting All enabled

Command Mode Global Configuration

Example This example restricts management access to the indicated addresses.

```
Enterprise AP(config)#apmgmtui SNMP enable
Enterprise AP(config)#
```

show apmanagement

This command shows the AP management configuration, including the IP addresses of management stations allowed to access the BSAP-1600, as well as the interface protocols which are open to management access.

Command Mode Exec

Example

```
Enterprise AP#show apmanagement
Management AP Information
=====
AP Management IP Mode: Any IP
Telnet UI: Enable
WEB UI   : Enable
SNMP UI  : Enable
=====
Enterprise AP#
```

show system

This command displays basic system configuration settings.

Default Setting None

Command Mode Exec

Example

```
Enterprise AP#show system
System Information
=====
Serial Number       : A123456789
System Up time      : 0 days, 4 hours, 33 minutes, 29 seconds
System Name         : Enterprise Wireless AP
System Location     :
System Contact      :
System Country Code : US - UNITED STATES
MAC Address         : 00-30-F1-F0-9A-9C
IP Address          : 192.168.1.1
Subnet Mask         : 255.255.255.0
Default Gateway     : 0.0.0.0
VLAN State          : DISABLED
Management VLAN ID (AP) : 1
IAPP State          : ENABLED
DHCP Client         : ENABLED
HTTP Server         : ENABLED
HTTP Server Port    : 80
HTTPS Server        : ENABLED
HTTPS Server Port   : 443
```

```
Slot Status           : Dual band(a/g)
Boot Rom Version      : v3.0.3
Software Version      : v4.3.1.9
SSH Server            : ENABLED
SSH Server Port       : 22
Telnet Server         : ENABLED
WEB Redirect          : DISABLED
DHCP Relay            : DISABLED
Proxy ARP             : DISABLED
=====
Enterprise AP#
```

show version

This command displays the software version for the system.

Command Mode Exec

Example

```
Enterprise AP#show version

Version Information
=====
Version: v4.3.2.2
Date   : Dec 20 2005, 18:38:12
=====
Enterprise AP#
```

show config

This command displays detailed configuration information for the system.

Command Mode Exec

Example

```
Enterprise AP#show config

Authentication Information
=====
MAC Authentication Server      : DISABLED
MAC Auth Session Timeout Value : 0 min
802.1x supplicant             : DISABLED
802.1x supplicant user        : EMPTY
802.1x supplicant password    : EMPTY
Address Filtering              : ALLOWED

System Default : ALLOW addresses not found in filter table.
Filter Table
-----
No Filter Entries.

Bootfile Information
=====
Bootfile : ec-img.bin
=====

Protocol Filter Information
=====
Local Bridge      :DISABLED
AP Management     :ENABLED
Ethernet Type Filter :DISABLED

Enabled Protocol Filters
-----
No protocol filters are enabled
=====
```

```

Hardware Version Information
=====
Hardware version R01A
=====

Ethernet Interface Information
=====
IP Address       : 192.168.0.151
Subnet Mask     : 255.255.255.0
Default Gateway : 192.168.0.1
Primary DNS     : 210.200.211.225
Secondary DNS   : 210.200.211.193
Speed-duplex    : 100Base-TX Full Duplex
Admin status    : Up
Operational status : Up
=====

Wireless Interface 802.11a Information
=====
-----Identification-----
Description      : Enterprise 802.11a Access Point
SSID            : VAP_TEST_11A 0
Channel         : 0 (AUTO)
Status          : Disable
-----802.11 Parameters-----
Transmit Power  : 100% (5 dBm)
Data Rate       : 54Mbps
Fragmentation Threshold : 2346 bytes
RTS Threshold   : 2347 bytes
Beacon Interval : 100 TUs
DTIM Interval   : 1 beacon
Maximum Association : 64 stations
Native VLAN ID  : 1
-----Security-----
Closed System   : DISABLED
Multicast cipher : WEP
Unicast cipher  : TKIP and AES
WPA clients     : REQUIRED
WPA Key Mgmt Mode : PRE SHARED KEY
WPA PSK Key Type : ALPHANUMERIC
Encryption      : DISABLED
Default Transmit Key : 1
Static Keys :
  Key 1: EMPTY   Key 2: EMPTY   Key 3: EMPTY   Key 4: EMPTY
Key Length :
  Key 1: ZERO    Key 2: ZERO    Key 3: ZERO    Key 4: ZERO
Authentication Type : OPEN
Rogue AP Detection : Disabled
Rogue AP Scan Interval : 720 minutes
Rogue AP Scan Duration : 350 milliseconds
=====

Console Line Information
=====
databits : 8
parity   : none
speed    : 9600
stop bits : 1
=====

```

```
Logging Information
=====
Syslog State           : Disabled
Logging Console State  : Disabled
Logging Level          : Informational
Logging Facility Type  : 16
Servers
  1: 0.0.0.0           , UDP Port: 514, State: Disabled
  2: 0.0.0.0           , UDP Port: 514, State: Disabled
  3: 0.0.0.0           , UDP Port: 514, State: Disabled
  4: 0.0.0.0           , UDP Port: 514, State: Disabled
=====

Radius Server Information
=====
IP                     : 0.0.0.0
Port                   : 1812
Key                    : *****
Retransmit             : 3
Timeout                : 5
Radius MAC format      : no-delimiter
Radius VLAN format     : HEX
=====

Radius Secondary Server Information
=====
IP                     : 0.0.0.0
Port                   : 1812
Key                    : *****
Retransmit             : 3
Timeout                : 5
Radius MAC format      : no-delimiter
Radius VLAN format     : HEX
=====

SNMP Information
=====
Service State          : Disable
Community (ro)         : *****
Community (rw)         : *****
Location               :
Contact                : Contact

EngineId               :80:00:07:e5:80:00:00:29:f6:00:00:00:0c
EngineBoots:2

Trap Destinations:
  1: 0.0.0.0, Community: *****, State: Disabled
  2: 0.0.0.0, Community: *****, State: Disabled
  3: 0.0.0.0, Community: *****, State: Disabled
  4: 0.0.0.0, Community: *****, State: Disabled
```

dot11InterfaceAGFail	Enabled	dot11InterfaceBFail	Enabled
dot11StationAssociation	Enabled	dot11StationAuthentication	Enabled
dot11StationReAssociation	Enabled	dot11StationRequestFail	Enabled
dot1xAuthFail	Enabled	dot1xAuthNotInitiated	Enabled
dot1xAuthSuccess	Enabled	dot1xMacAddrAuthFail	Enabled
dot1xMacAddrAuthSuccess	Enabled	iappContextDataSent	Enabled
iappStationRoamedFrom	Enabled	iappStationRoamedTo	Enabled
localMacAddrAuthFail	Enabled	localMacAddrAuthSuccess	Enabled
pppLogonFail	Enabled	sntpServerFail	Enabled
configFileVersionChanged	Enabled	radiusServerChanged	Enabled
systemDown	Enabled	systemUp	Enabled

=====
SNTP Information

=====
Service State : Disabled
SNTP (server 1) IP : 137.92.140.80
SNTP (server 2) IP : 192.43.244.18
Current Time : 00 : 14, Jan 1st, 1970
Time Zone : -5 (BOGOTA, EASTERN, INDIANA)
Daylight Saving : Disabled
=====

Station Table Information

=====
if-wireless A VAP [0] :
802.11a Channel : Auto

No 802.11a Channel Stations.
. . .
if-wireless G VAP [0] :
802.11g Channel : Auto

No 802.11g Channel Stations.
. . .

System Information

=====
Serial Number :
System Up time : 0 days, 0 hours, 16 minutes, 51 seconds
System Name : Enterprise Wireless AP
System Location :
System Contact : Contact
System Country Code : 99 - NO_COUNTRY_SET
MAC Address : 00-12-CF-05-B7-84
IP Address : 192.168.0.151
Subnet Mask : 255.255.255.0
Default Gateway : 192.168.0.1
VLAN State : DISABLED
Management VLAN ID(AP): 1
IAPP State : ENABLED
DHCP Client : ENABLED
HTTP Server : ENABLED
HTTP Server Port : 80
HTTPS Server : ENABLED
HTTPS Server Port : 443
Slot Status : Dual band(a/g)
Boot Rom Version : v3.0.7
Software Version : v4.3.2.2

```
SSH Server      : ENABLED
SSH Server Port : 22
Telnet Server   : ENABLED
WEB Redirect    : DISABLED
DHCP Relay      : DISABLED
=====
```

Version Information

```
=====
Version: v4.3.2.2
Date   : Dec 20 2005, 18:38:12
=====
```

Enterprise AP#

show hardware

7-27 This command displays the hardware version of the system.

Command Mode Exec

Example

```
Enterprise AP#show hardware

Hardware Version Information
=====
Hardware version R01
=====
Enterprise AP#
```

System Logging Commands

These commands are used to configure system logging on the BSAP-1600.

Table 7-7: System Logging Commands

Command	Function	Mode	Page
logging on	Controls logging of error messages	GC	7-27
logging host	Adds a syslog server host IP address that will receive logging messages	GC	7-27
logging console	Initiates logging of error messages to the console	GC	7-27
logging level	Defines the minimum severity level for event logging	GC	7-28
logging facility-type	Sets the facility type for remote logging of syslog messages	GC	7-28
logging clear	Clears all log entries in the BSAP-1600 memory	GC	7-29
show logging	Displays the state of logging	Exec	7-29
show event-log	Displays all log entries in the BSAP-1600 memory	Exec	7-29

logging on

This command controls logging of error messages; i.e., sending debug or error messages to memory. The **no** form disables the logging process.

Syntax [no] logging on

Default Setting Disabled

Command Mode Global Configuration

Command Usage The logging process controls error messages saved to memory. You can use the **logging level** command to control the type of error messages that are stored in memory.

Example

```
Enterprise AP(config)#logging on
Enterprise AP(config)#
```

logging host

This command specifies syslog servers host that will receive logging messages. Use the **no** form to remove syslog server host.

Syntax logging host <1 | 2 | 3 | 4> <host_name | host_ip_address> [udp_port]
no logging host <1 | 2 | 3 | 4>

- 1 - First syslog server.
- 2 - Second syslog server.
- 3 - Third syslog server.
- 4 - Fourth syslog server.
- *host_name* - The name of a syslog server. (Range: 1-20 characters)
- *host_ip_address* - The IP address of a syslog server.
- *udp_port* - The UDP port used by the syslog server.

Default Setting None

Command Mode Global Configuration

Example

```
Enterprise AP(config)#logging host 1 10.1.0.3
Enterprise AP(config)#
```

logging console

This command initiates logging of error messages to the console. Use the **no** form to disable logging to the console.

Syntax logging console
no logging console

Default Setting Disabled

Command Mode Global Configuration

Example

```
Enterprise AP(config)#logging console
Enterprise AP(config)#
```

logging level

This command sets the minimum severity level for event logging.

Syntax logging level <Emergency | Alert | Critical | Error | Warning | Notice | Informational | Debug>

Default Setting Informational

Command Mode Global Configuration

Command Usage Messages sent include the selected level down to Emergency level.

Table 7-8: Logging Level Message Descriptions

Level Argument	Description
Emergency	System unusable
Alert	Immediate action needed
Critical	Critical conditions (e.g., memory allocation, or free memory error - resource exhausted)
Error	Error conditions (e.g., invalid input, default used)
Warning	Warning conditions (e.g., return false, unexpected return)
Notice	Normal but significant condition, such as cold start
Informational	Informational messages only
Debug	Debugging messages

Example

```
Enterprise AP(config)#logging level alert
Enterprise AP(config)#
```

logging facility-type

This command sets the facility type for remote logging of syslog messages.

Syntax logging facility-type <type>
type - A number that indicates the facility used by the syslog server to dispatch log messages to an appropriate service. (Range: 16-23)

Default Setting 16

Command Mode Global Configuration

Command Usage The command specifies the facility type tag sent in syslog messages. This type has no effect on the kind of messages reported by the BSAP-1600. However, it may be used by the syslog server to sort messages or to store messages in the corresponding database.

Example

```
Enterprise AP(config)#logging facility 19
Enterprise AP(config)#
```

logging clear

This command clears all log messages stored in the BSAP-1600's memory.

Syntax logging clear

Command Mode Global Configuration

Example

```
Enterprise AP(config)#logging clear
Enterprise AP(config)#
```

show logging

This command displays the logging configuration.

Syntax show logging

Command Mode Exec

Example

```
Enterprise AP#show logging
Logging Information
=====
Syslog State           : Enabled
Logging Console State  : Enabled
Logging Level          : Alert
Logging Facility Type  : 16
Servers
  1: 192.168.1.19, UDP Port: 514, State: Enabled
  2: 0.0.0.0, UDP Port: 514, State: Disabled
  3: 0.0.0.0, UDP Port: 514, State: Disabled
  4: 0.0.0.0, UDP Port: 514, State: Disabled
=====
Enterprise AP#
```

show event-log

This command displays log messages stored in the BSAP-1600's memory.

Syntax show event-log

Command Mode Exec

Example

```

Enterprise AP#show event-log
Mar 09 11:57:55 Information: 802.11g:11g Radio Interface Enabled
Mar 09 11:57:55 Information: 802.11g:Radio channel updated to 8
Mar 09 11:57:34 Information: 802.11g:11g Radio Interface Enabled
Mar 09 11:57:18 Information: 802.11g:11g Radio Interface Enabled
Mar 09 11:56:35 Information: 802.11a:11a Radio Interface Enabled
Mar 09 11:55:52 Information: SSH task: Set SSH server port to 22
Mar 09 11:55:52 Information: SSH task: Enable SSH server.
Mar 09 11:55:52 Information: Enable Telnet.
Mar 09 11:55:40 Information: 802.11a:11a Radio Interface Disabled
Mar 09 11:55:40 Information: 802.11a:Transmit Power set to QUARTER
Press <n> next. <p> previous. <a> abort. <y> continue to end :
Enterprise AP#configure
Enter configuration commands, one per line. End with CTRL/Z
Enterprise AP(config)#logging clear

```

System Clock Commands

These commands are used to configure SNTP and system clock settings on the BSAP-1600.

Table 7-9: System Clock Commands

Command	Function	Mode	Page
sntp-server ip	Specifies one or more time servers	GC	7-30
sntp-server enable	Accepts time from the specified time servers	GC	7-31
sntp-server datetime	Manually sets the system date and time	GC	7-31
sntp-server daylight-saving	Sets the start and end dates for daylight savings time	GC	7-32
sntp-server timezone	Sets the time zone for the BSAP-1600's internal clock	GC	7-32
show sntp	Shows current SNTP configuration settings	Exec	7-32

sntp-server ip

This command sets the IP address of the servers to which SNTP time requests are issued. Use the this command with no arguments to clear all time servers from the current list.

Syntax sntp-server ip <1 | 2> <ip>

- 1 - First time server.
- 2 - Second time server.
- ip - IP address of an time server (NTP or SNTP).

Default Setting 137.92.140.80
192.43.244.18

Command Mode Global Configuration

Command Usage When SNTP client mode is enabled using the **sntp-server enable** command, the **sntp-server ip** command specifies the time servers from which the BSAP-1600 polls for time

updates. The BSAP-1600 will poll the time servers in the order specified until a response is received.

Example

```
Enterprise AP(config)#ntp-server ip 10.1.0.19
Enterprise AP#
```

Related Commands ntp-server enable

ntp-server enable

This command enables SNTP client requests for time synchronization with NTP or SNTP time servers specified by the **ntp-server ip** command. Use the **no** form to disable SNTP client requests.

Syntax ntp-server enable
no ntp-server enable

Default Setting Enabled

Command Mode Global Configuration

Command Usage The time acquired from time servers is used to record accurate dates and times for log events. Without SNTP, the BSAP-1600 only records the time starting from the factory default set at the last bootup (i.e., 00:14:00, January 1, 1970).

Example

```
Enterprise AP(config)#ntp-server enable
Enterprise AP(config)#
```

Related Commands ntp-server ip

ntp-server date-time

This command sets the system clock.

Default Setting 00:14:00, January 1, 1970

Command Mode Global Configuration

Example This example sets the system clock to 17:37 June 19, 2003.

```
Enterprise AP#ntp-server date-time
Enter Year<1970-2100>: 2003
Enter Month<1-12>: 6
Enter Day<1-31>: 19
Enter Hour<0-23>: 17
Enter Min<0-59>: 37
Enterprise AP#
```

Related Commands ntp-server enable

sntp-server daylight-saving

This command sets the start and end dates for daylight savings time. Use the **no** form to disable daylight savings time.

Syntax sntp-server daylight-saving
no sntp-server daylight-saving

Default Setting Disabled

Command Mode Global Configuration

Command Usage The command sets the system clock back one hour during the specified period.

Example This sets daylight savings time to be used from July 1st to September 1st.

```
Enterprise AP(config)#sntp-server daylight-saving
Enter Daylight saving from which month<1-12>: 6
and which day<1-31>: 1
Enter Daylight saving end to which month<1-12>: 9
and which day<1-31>: 1
Enterprise AP(config)#
```

sntp-server timezone

This command sets the time zone for the BSAP-1600's internal clock.

Syntax sntp-server timezone <hours>
hours - Number of hours before/after UTC.
(Range: -12 to +12 hours)

Default Setting -5 (BOGOTA, EASTERN, INDIANA)

Command Mode Global Configuration

Command Usage This command sets the local time zone relative to the Coordinated Universal Time (UTC, formerly Greenwich Mean Time or GMT), based on the earth's prime meridian, zero degrees longitude. To display a time corresponding to your local time, you must indicate the number of hours and minutes your time zone is east (before) or west (after) of UTC.

Example

```
Enterprise AP(config)#sntp-server timezone +8
Enterprise AP(config)#
```

show sntp

This command displays the current time and configuration settings for the SNTP client.

Command Mode Exec

Example

```

Enterprise AP#show sntp
SNTP Information
=====
Service State      : Enabled
SNTP (server 1) IP : 137.92.140.80
SNTP (server 2) IP : 192.43.244.18
Current Time       : 08 : 04, Jun 20th, 2003
Time Zone          : +8 (TAIPEI, BEIJING)
Daylight Saving    : Enabled, from Jun, 1st to Sep, 1st
=====
Enterprise AP#

```

DHCP Relay Commands

Dynamic Host Configuration Protocol (DHCP) can dynamically allocate an IP address and other configuration information to network clients that broadcast a request. To receive the broadcast request, the DHCP server would normally have to be on the same subnet as the client. However, when the BSAP-1600's DHCP relay agent is enabled, received client requests can be forwarded directly by the BSAP-1600 to a known DHCP server on another subnet. Responses from the DHCP server are returned to the BSAP-1600, which then broadcasts them back to clients.

Table 7-10: DHCP Relay Commands

Command	Function	Mode	Page
dhcp-relay enable	Enables the DHCP relay agent	GC	7-33
dhcp-relay	Sets the primary and secondary DHCP server address	GC	7-34
show dhcp-relay	Shows current DHCP relay configuration settings	Exec	7-34

dhcp-relay enable

This command enables the BSAP-1600's DHCP relay agent. Use the **no** form to disable the agent.

Syntax [no] dhcp-relay enable

Default Setting Disabled

Command Mode Global Configuration

- Command Usage**
- For the DHCP relay agent to function, the primary DHCP server must be configured using the **dhcp-relay primary** command. A secondary DHCP server does not need to be configured, but it is recommended.
 - If there is no response from the primary DHCP server, and a secondary server has been configured, the agent will then attempt to send DHCP requests to the secondary server.

Example

```
Enterprise AP(config)#dhcp-relay enable
Enterprise AP(config)#
```

dhcp-relay

This command configures the primary and secondary DHCP server addresses.

Syntax `dhcp-relay <primary | secondary> <ip_address>`

- **primary** - The primary DHCP server.
- **secondary** - The secondary DHCP server.
- *ip_address* - IP address of the server.

Default Setting Primary and secondary: 0.0.0.0

Command Mode Global Configuration

Example

```
Enterprise AP(config)#dhcp-relay primary 192.168.1.10
Enterprise AP(config)#
```

show dhcp-relay

This command displays the current DHCP relay configuration.

Command Mode Exec

Example

```
Enterprise AP#show dhcp-relay
DHCP Relay      : ENABLED
Primary DHCP Server : 192.168.1.10
Secondary DHCP Server : 0.0.0.0
Enterprise AP#
```

SNMP Commands

Controls access to this BSAP-1600 from management stations using the Simple Network Management Protocol (SNMP), as well as the hosts that will receive trap messages.

Table 7-11: SNMP Commands

Command	Function	Mode	Page
snmp-server community	Sets up the community access string to permit access to SNMP commands	GC	7-35
snmp-server contact	Sets the system contact string	GC	7-36
snmp-server location	Sets the system location string	GC	7-36
snmp-server enable server	Enables SNMP service and traps	GC	7-37
snmp-server host	Specifies the recipient of an SNMP notification operation	GC	7-37
snmp-server trap	Enables specific SNMP notifications	GC	7-38
snmp-server engine id	Sets the engine ID for SNMP v3	GC	7-39
snmp-server user	Sets the name of the SNMP v3 user	GC	7-40
snmp-server targets	Configures SNMP v3 notification targets	GC	7-41
snmp-server filter	Configures SNMP v3 notification filters	GC	7-42
snmp-server filter-assignments	Assigns SNMP v3 notification filters to targets	GC	7-43
show snmp groups	Displays the pre-defined SNMP v3 groups	Exec	7-43
show snmp users	Displays SNMP v3 user settings	Exec	7-44
show snmp group-assignments	Displays the assignment of users to SNMP v3 groups	Exec	7-44
show snmp target	Displays the SNMP v3 notification targets	Exec	7-45
show snmp filter	Displays the SNMP v3 notification filters	Exec	7-45
show snmp filter-assignments	Displays the SNMP v3 notification filter assignments	Exec	7-45
show snmp	Displays the status of SNMP communications	Exec	7-46

snmp-server community

This command defines the community access string for the Simple Network Management Protocol. Use the **no** form to remove the specified community string.

Syntax `snmp-server community string [ro | rw]`
`no snmp-server community string`

- *string* - Community string that acts like a password and permits access to the SNMP protocol. (Maximum length: 23 characters, case sensitive)
- **ro** - Specifies read-only access. Authorized management stations are only able to retrieve MIB objects.
- **rw** - Specifies read/write access. Authorized management stations are able to both retrieve and modify MIB objects.

Default Setting

- **public** - Read-only access. Authorized management stations are only able to retrieve MIB objects.
- **private** - Read/write access. Authorized management stations are able to both retrieve and modify MIB objects.

Command Mode Global Configuration

Command Usage If you enter a community string without the **ro** or **rw** option, the default is read only.

Example

```
Enterprise AP(config)#snmp-server community alpha rw
Enterprise AP(config)#
```

snmp-server contact

This command sets the system contact string. Use the **no** form to remove the system contact information.

Syntax **snmp-server contact** *string*
no snmp-server contact

string - String that describes the system contact. (Maximum length: 255 characters)

Default Setting None

Command Mode Global Configuration

Example

```
Enterprise AP(config)#snmp-server contact Paul
Enterprise AP(config)#
```

Related Commands snmp-server location

snmp-server location

This command sets the system location string. Use the **no** form to remove the location string.

Syntax **snmp-server location** *<text>*
no snmp-server location

text - String that describes the system location. (Maximum length: 255 characters)

Default Setting None

Command Mode Global Configuration

Example

```
Enterprise AP(config)#snmp-server location WC-19
Enterprise AP(config)#
```

Related Commands snmp-server contact

snmp-server enable server

This command enables SNMP management access and also enables this device to send SNMP traps (i.e., notifications). Use the **no** form to disable SNMP service and trap messages.

Syntax snmp-server enable server
no snmp-server enable server

Default Setting Enabled

Command Mode Global Configuration

Command Usage

- This command enables both authentication failure notifications and link-up-down notifications.
- The **snmp-server host** command specifies the host device that will receive SNMP notifications.

Example

```
Enterprise AP(config)#snmp-server enable server
Enterprise AP(config)#
```

Related Commands snmp-server host

snmp-server host

This command specifies the recipient of an SNMP notification. Use the **no** form to remove the specified host.

Syntax snmp-server host <1 | 2 | 3 | 4> <host_ip_address | host_name> <community-string>
no snmp-server host

- 1 - First SNMP host.
- 2 - Second SNMP host.
- 3 - Third SNMP host.
- 4 - Fourth SNMP host.
- *host_ip_address* - IP of the host (the targeted recipient).
- *host_name* - Name of the host. (Range: 1-63 characters)

- *community-string* - Password-like community string sent with the notification operation. Although you can set this string using the **snmpserver host** command by itself, we recommend that you define this string using the **snmp-server community** command prior to using the **snmp-server host** command. (Maximum length: 23 characters)

Default Setting Host Address: None
Community String: public

Command Mode Global Configuration

Command Usage The **snmp-server host** command is used in conjunction with the **snmp-server enable server** command to enable SNMP notifications.

Example

```
Enterprise AP(config)#snmp-server host 1 10.1.19.23 batman
Enterprise AP(config)#
```

Related Commands snmp-server enable server

snmp-server trap

This command enables the BSAP-1600 to send specific SNMP traps (i.e., notifications). Use the **no** form to disable specific trap messages.

Syntax **snmp-server trap** <trap>
no snmp-server trap <trap>

- *trap* - One of the following SNMP trap messages:
 - **dot11InterfaceAGFail** - The 802.11a or 802.11g interface has failed.
 - **dot11InterfaceBFail** - The 802.11b interface has failed.
 - **dot11StationAssociation** - A client station has successfully associated with the BSAP-1600.
 - **dot11StationAuthentication** - A client station has been successfully authenticated.
 - **dot11StationReAssociation** - A client station has successfully re-associated with the BSAP-1600.
 - **dot11StationRequestFail** - A client station has failed association, re-association, or authentication.
 - **dot1xAuthFail** - A 802.1X client station has failed RADIUS authentication.
 - **dot1xAuthNotInitiated** - A client station did not initiate 802.1X authentication.
 - **dot1xAuthSuccess** - A 802.1X client station has been successfully authenticated by the RADIUS server.
 - **dot1xMacAddrAuthFail** - A client station has failed MAC address authentication with the RADIUS server.
 - **dot1xMacAddrAuthSuccess** - A client station has successfully authenticated its MAC address with the RADIUS server.

- **iappContextDataSent** - A client station's Context Data has been sent to another BSAP-1600 with which the station has associated.
- **iappStationRoamedFrom** - A client station has roamed from another BSAP-1600 (identified by its IP address).
- **iappStationRoamedTo** - A client station has roamed to another BSAP-1600 (identified by its IP address).
- **localMacAddrAuthFail** - A client station has failed authentication with the local MAC address database on the BSAP-1600.
- **localMacAddrAuthSuccess** - A client station has successfully authenticated its MAC address with the local database on the BSAP-1600.
- **pppLogonFail** - The BSAP-1600 has failed to log onto the PPPoE server using the configured user name and password.
- **sntpServerFail** - The BSAP-1600 has failed to set the time from the configured SNTP server.
- **sysConfigFileVersionChanged** - The BSAP-1600's configuration file has been changed.
- **sysRadiusServerChanged** - The BSAP-1600 has changed from the primary RADIUS server to the secondary, or from the secondary to the primary.
- **sysSystemDown** - The BSAP-1600 is about to shutdown and reboot.
- **sysSystemUp** - The BSAP-1600 is up and running.

Default Setting All traps enabled

Command Mode Global Configuration

Command Usage This command is used in conjunction with the **snmp-server host** and **snmp-server enable server** commands to enable SNMP notifications.

Example

```
Enterprise AP(config)#no snmp-server trap dot11StationAssociation
Enterprise AP(config)#
```

snmp-server engine-id

This command is used for SNMP v3. It is used to uniquely identify the BSAP-1600 among all access points in the network. Use the **no** form to delete the engine ID.

Syntax **snmp-server engine-id** <engine-id>
no snmp-server engine-id
engine-id - Enter engine-id in hexadecimal (5-32 characters).

Default Setting Enabled

Command Mode Global Configuration

- Command Usage**
- This command is used in conjunction with the **snmp-server user** command.
 - Entering this command invalidates all engine IDs that have been previously configured.
 - If the engineID is deleted or changed, all SNMP users will be cleared. You will need to reconfigure all existing users

Example

```
Enterprise AP(config)#snmp-server engine-id 1a:2b:3c:4d:00:ff
Enterprise AP(config)#
```

snmp-server user

This command configures the SNMP v3 users that are allowed to manage the BSAP-1600. Use the **no** form to delete an SNMP v3 user.

- Syntax** **snmp-server user** <user-name>
user-name - A user-defined string for the SNMP user. (32 characters maximum)

Default Setting None

Command Mode Global Configuration

- Command Usage**
- Up to 10 SNMPv3 users can be configured on the BSAP-1600.
 - The SNMP engine ID is used to compute the authentication/privacy digests from the pass phrase. You should therefore configure the engine ID with the **snmp-server engine-id** command before using this configuration command.
 - The BSAP-1600 enables SNMP v3 users to be assigned to three pre-defined groups. Other groups cannot be defined. The available groups are:
 - RO - A read-only group using no authentication and no data encryption. Users in this group use no security, either authentication or encryption, in SNMP messages they send to the agent. This is the same as SNMP v1 or SNMP v2c.
 - RWAuth - A read/write group using authentication, but no data encryption. Users in this group send SNMP messages that use an MD5 key/password for authentication, but not a DES key/password for encryption.
 - RWPriv - A read/write group using authentication and data encryption. Users in this group send SNMP messages that use an MD5 key/password for authentication and a DES key/password for encryption. Both the MD5 and DES key/passwords must be defined.
 - The command prompts for the following information to configure an SNMP v3 user:
 - *user-name* - A user-defined string for the SNMP user. (32 characters maximum)
 - *group-name* - The name of the SNMP group to which the user is assigned (32 characters maximum). There are three pre-defined groups: RO, RWAuth, or RWPriv.

- *auth-proto* - The authentication type used for user authentication: md5 or none.
- *auth-passphrase* - The user password required when authentication is used (8 – 32 characters).
- *priv-proto* - The encryption type used for SNMP data encryption: des or none.
- *priv-passphrase* - The user password required when data encryption is used (8 – 32 characters).
- Users must be assigned to groups that have the same security levels. If a user who has “AuthPriv” security (uses authentication and encryption) is assigned to a read-only (RO) group, the user will not be able to access the database. An AuthPriv user must be assigned to the RWPriv group with the AuthPriv security level.
- To configure a user for the RWAuth group, you must include the *auth-proto* and *auth-passphrase* keywords.
- To configure a user for the RWPriv group, you must include the *auth-proto*, *auth-passphrase*, *priv-proto*, and *priv-passphrase* keywords.

Example

```
Enterprise AP(config)#snmp-server user
User Name<1-32> :chris
Group Name<1-32> :RWPriv
Authtype(md5,<cr>none):md5
Passphrase<8-32>:a good secret
Privacy(des,<cr>none) :des
Passphrase<8-32>:a very good secret
Enterprise AP(config)#
```

snmp-server targets

This command configures SNMP v3 notification targets. Use the **no** form to delete an SNMP v3 target.

Syntax **snmp-server targets** <target-id> <ip-addr> <sec-name>
 [version {3}] [udp-port {port-number}] [notification-type
 {TRAP}]

no snmp-server targets <target-id>

- *target-id* - A user-defined name that identifies a receiver of SNMP notifications. (Maximum length: 32 characters)
- *ip-addr* - Specifies the IP address of the management station to receive notifications.
- *sec-name* - The defined SNMP v3 user name that is to receive notifications.
- **version** - The SNMP version of notifications. Currently only version **3** is supported in this command.
- **udp-port** - The UDP port that is used on the receiving management station for notifications.
- **notification-type** - The type of notification that is sent. Currently only **TRAP** is supported.

Default Setting None

Command Mode Global Configuration

Command Usage

- The BSAP-1600 supports up to 10 SNMP v3 target IDs.
- The SNMP v3 user name that is specified in the target must first be configured using the **snmp-server user** command.

Example

```
Enterprise AP(config)#snmp-server targets mytraps 192.168.1.33 chris
Enterprise AP(config)#
```

snmp-server filter

This command configures SNMP v3 notification filters. Use the **no** form to delete an SNMP v3 filter or remove a subtree from a filter.

Syntax **snmp-server filter** <filter-id> <include | exclude> <subtree>
[mask {mask}]
no snmp-server filter <filter-id> [subtree]

- *filter-id* - A user-defined name that identifies an SNMP v3 notification filter. (Maximum length: 32 characters)
- **include** - Defines a filter type that includes objects in the MIB subtree.
- **exclude** - Defines a filter type that excludes objects in the MIB subtree.
- *subtree* - The part of the MIB subtree that is to be filtered.
- *mask* - An optional hexadecimal value bit mask to define objects in the MIB subtree.

Default Setting None

Command Mode Global Configuration

Command Usage

- The BSAP-1600 allows up to 10 notification filters to be created. Each filter can be defined by up to 20 MIB subtree ID entries.
- Use the command more than once with the same filter ID to build a filter that includes or excludes multiple MIB objects. Note that the filter entries are applied in the sequence that they are defined.
- The MIB subtree must be defined in the form ".1.3.6.1" and always start with a ".".
- The mask is a hexadecimal value with each bit masking the corresponding ID in the MIB subtree. A "1" in the mask indicates an exact match and a "0" indicates a "wild card." For example, a mask value of 0xFFBF provides a bit mask "1111 1111 1011 1111." If applied to the subtree 1.3.6.1.2.1.2.2.1.1.23, the zero corresponds to the 10th subtree ID. When there are more subtree IDs than bits in the mask, the mask is padded with ones.

Example

```
Enterprise AP(config)#snmp-server filter trapfilter include .1
Enterprise AP(config)#snmp-server filter trapfilter exclude
.1.3.6.1.2.1.2.2.1.1.23
```

snmp-server filter-assignments

This command assigns SNMP v3 notification filters to targets. Use the **no** form to remove an SNMP v3 filter assignment.

Syntax `snmp-server filter-assignments <target-id> <filter-id>`
`no snmp-server filter-assignments <target-id>`

- *target-id* - A user-defined name that identifies a receiver of SNMP notifications. (Maximum length: 32 characters)
- *filter-id* - A user-defined name that identifies an SNMP v3 notification filter. (Maximum length: 32 characters)

Default Setting None

Command Mode Global Configuration

Example

```
Enterprise AP(config)#snmp-server filter-assignments mytraps trapfilter
Enterprise AP(config)#exit
Enterprise AP#show snmp target

Host ID       : mytraps
User          : chris
IP Address    : 192.168.1.33
UDP Port      : 162
=====
Enterprise AP#show snmp filter-assignments

                               HostID  FilterID
                               -----
                               mytraps trapfilter

Enterprise AP(config)#
```

show snmp groups

This command displays the SNMP v3 pre-defined groups.

Syntax `show snmp groups`

Command Mode Exec

Example

```
Enterprise AP#show snmp groups

GroupName      :RO
SecurityModel  :USM
SecurityLevel  :NoAuthNoPriv

GroupName      :RWAuth
SecurityModel  :USM
SecurityLevel  :AuthNoPriv

GroupName      :RWPriv
SecurityModel  :USM
SecurityLevel  :AuthPriv
Enterprise AP#
```

show snmp users

This command displays the SNMP v3 users and settings.

Syntax show snmp users

Command Mode Exec

Example

```
Enterprise AP#show snmp users

=====
UserName      :chris
GroupName     :RWPriv
AuthType      :MD5
  Passphrase:*****
PrivType      :DES
  Passphrase:*****
=====
Enterprise AP#
```

show snmp group-assignments

This command displays the SNMP v3 user group assignments.

Syntax show snmp group-assignments

Command Mode Exec

Example

```
Enterprise AP#show snmp group-assignments

GroupName     :RWPriv
UserName      :chris
Enterprise AP#

Enterprise AP#
```

show snmp target

This command displays the SNMP v3 notification target settings.

Syntax show snmp target

Command Mode Exec

Example

```
Enterprise AP#show snmp target
Host ID      : mytraps
User         : chris
IP Address   : 192.168.1.33
UDP Port     : 162
=====
Enterprise AP#
```

show snmp filter

This command displays the SNMP v3 notification filter settings.

Syntax show snmp filter [*filter-id*]

- *filter-id* - A user-defined name that identifies an SNMP v3 notification filter. (Maximum length: 32 characters)

Command Mode Exec

Example

```
Enterprise AP#show snmp filter
Filter: trapfilter
  Type: include
  Subtree: iso.3.6.1.2.1.2.2.1

  Type: exclude
  Subtree: iso.3.6.1.2.1.2.2.1.1.23
=====
Enterprise AP#
```

show snmp filter-assignments

This command displays the SNMP v3 notification filter assignments.

Syntax show snmp filter-assignments

Command Mode Exec

Example

```
Enterprise AP#show snmp filter-assignments

                HostID  FilterID
                -----
                mytraps trapfilter

Enterprise AP#
```

show snmp

This command displays the SNMP configuration settings.

Command Mode Exec

Example

```
Enterprise AP#show snmp

SNMP Information
=====
Service State           : Enable
Community (ro)         : *****
Community (rw)         : *****
Location                : WC-19
Contact                 : Paul

EngineId      :80:00:07:e5:80:00:00:2e:62:00:00:00:18
EngineBoots:1

Trap Destinations:
  1:      192.168.1.9, Community: *****, State: Enabled
  2:      0.0.0.0, Community: *****, State: Disabled
  3:      0.0.0.0, Community: *****, State: Disabled
  4:      0.0.0.0, Community: *****, State: Disabled

dot11InterfaceAGFail Enabled      dot11InterfaceBFail Enabled
dot11StationAssociation Enabled dot11StationAuthentication
Enabled
dot11StationReAssociation Enabled  dot11StationRequestFail
Enabled
dot1xAuthFail Enabled      dot1xAuthNotInitiated Enabled
dot1xAuthSuccess Enabled   dot1xMacAddrAuthFail Enabled
dot1xMacAddrAuthSuccess Enabled iappContextDataSent
Enabled
iappStationRoamedFrom Enabled   iappStationRoamedTo
Enabled
localMacAddrAuthFail Enabled   localMacAddrAuthSuccess Enabled
pppLogonFail Enabled          snmpServerFail Enabled
configFileVersionChanged Enabled radiusServerChanged
Enabled
systemDown Enabled            systemUp Enabled
=====
Enterprise AP#
```

Flash/File Commands

These commands are used to manage the system code or configuration files.

Table 7-12: Flash/File Commands

Command	Function	Mode	Page
bootfile	Specifies the file or image used to start up the system	GC	7-47
copy	Copies a code image or configuration between flash memory and a FTP/TFTP server	Exec	7-48
delete	Deletes a file or code image	Exec	7-49
dir	Displays a list of files in flash memory	Exec	7-49
show bootfile	Displays the name of the current operation code file that booted the system	Exec	7-50

bootfile

This command specifies the image used to start up the system.

Syntax `bootfile <filename>`
filename - Name of the image file.

Default Setting None

Command Mode Exec

Command Usage

- The file name should not contain slashes (\ or /), the leading letter of the file name should not be a period (.), and the maximum length for file names is 32 characters. (Valid characters: A-Z, a-z, 0-9, ".", "-", "_")
- If the file contains an error, it cannot be set as the default file.

Example

```
Enterprise AP#bootfile -img.bin
Enterprise AP#
```

copy

This command copies a boot file, code image, or configuration file between the BSAP-1600's flash memory and a FTP/TFTP server. When you save the configuration settings to a file on a FTP/TFTP server, that file can later be downloaded to the BSAP-1600 to restore system operation. The success of the file transfer depends on the accessibility of the FTP/TFTP server and the quality of the network connection.

Syntax `copy <ftp | tftp> file`
`copy config <ftp | tftp>`

- **ftp** - Keyword that allows you to copy to/from an FTP server.
- **tftp** - Keyword that allows you to copy to/from a TFTP server.
- **file** - Keyword that allows you to copy to/from a flash memory file.
- **config** - Keyword that allows you to upload the configuration file from flash memory.

Default Setting None

Command Mode Exec

- Command Usage**
- The system prompts for data required to complete the copy command.
 - Only a configuration file can be uploaded to an FTP/TFTP server, but every type of file can be downloaded to the BSAP-1600.
 - The destination file name should not contain slashes (\ or /), the leading letter of the file name should not be a period (.), and the maximum length for file names on the FTP/TFTP server is 255 characters or 32 characters for files on the BSAP-1600. (Valid characters: A-Z, a-z, 0-9, ".", "-", "_")
 - Due to the size limit of the flash memory, the BSAP-1600 supports only two operation code files.
 - The system configuration file must be named "syscfg" in all copy commands.

Example The following example shows how to upload the configuration settings to a file on the TFTP server:

```
Enterprise AP#copy config tftp
TFTP Source file name:syscfg
TFTP Server IP:192.168.1.19
Enterprise AP#
```

The following example shows how to download a configuration file:

```
Enterprise AP#copy tftp file
1. Application image
2. Config file
3. Boot block image
Select the type of download<1,2,3>: [1]:2
TFTP Source file name:syscfg
TFTP Server IP:192.168.1.19
Enterprise AP#
```

delete

This command deletes a file or image.

Syntax `delete <filename>`

filename - Name of the configuration file or image name.

Default Setting None

Command Mode Exec

Caution: Beware of deleting application images from flash memory. At least one application image is required in order to boot the BSAP-1600. If there are multiple image files in flash memory, and the one used to boot the BSAP-1600 is deleted, be sure you first use the **bootfile** command to update the application image file booted at startup before you reboot the BSAP-1600.

Example This example shows how to delete the test.cfg configuration file from flash memory.

```
Enterprise AP#delete test.cfg
Are you sure you wish to delete this file? <y/n>:
Enterprise AP#
```

Related Commands bootfile

dir

This command displays a list of files in flash memory.

Command Mode Exec

Command Usage File information is shown below:

Column Heading	Description
File Name	The name of the file.
Type	(2) Operation Code and (5) Configuration file
File Size	The length of the file in bytes.

Example The following example shows how to display all file information:

```
Enterprise AP#dir
File Name           Type   File Size
-----
dflt-img.bin       2      1044140
syscfg              5        16860
syscfg_bak         5        16860
zz-img.bin         2      1044140

      1048576 byte(s) available
Enterprise AP#
```

show bootfile

This command displays the name of the current operation code file that booted the system.

Syntax show snmp filter-assignments

Command Mode Exec

Example

```
Enterprise AP#show bootfile

Bootfile Information
=====
Bootfile : ec-img.bin
=====
Enterprise AP#
```

RADIUS Client

Remote Authentication Dial-in User Service (RADIUS) is a logon authentication protocol that uses software running on a central server to control access for RADIUS-aware devices to the network. An authentication server contains a database of credentials, such as users names and passwords, for each wireless client that requires access to the BSAP-1600.

Table 7-13: RADIUS Client

Command	Function	Mode	Page
radius-server address	Specifies the RADIUS server	GC	7-51
radius-server port	Sets the RADIUS server network port	GC	7-51
radius-server key	Sets the RADIUS encryption key	GC	7-51
radius-server retransmit	Sets the number of retries	GC	7-52
radius-server timeout	Sets the interval between sending authentication requests	GC	7-52
radius-server port-accounting	Sets the RADIUS Accounting server network port	GC	7-52
radius-server timeout-interim	Sets the interval between transmitting accounting updates to the RADIUS server	GC	7-53
radius-server radius-mac-format	Sets the format for specifying MAC addresses on the RADIUS server	GC	7-53
radius-server vlan-format	Sets the format for specifying VLAN IDs on the RADIUS server	GC	7-54
show radius	Shows the current RADIUS settings	Exec	7-54

radius-server address

This command specifies the primary and secondary RADIUS servers.

- Syntax** `radius-server [secondary] address <host_ip_address | host_name>`
- **secondary** - Secondary server.
 - *host_ip_address* - IP address of server.
 - *host_name* - Host name of server. (Range: 1-20 characters)

Default Setting None

Command Mode Global Configuration

Example

```
Enterprise AP(config)#radius-server address 192.168.1.25
Enterprise AP(config)#
```

radius-server port

This command sets the RADIUS server network port.

- Syntax** `radius-server [secondary] port <port_number>`
- **secondary** - Secondary server.
 - *port_number* - RADIUS server UDP port used for authentication messages. (Range: 1024-65535)

Default Setting 1812

Command Mode Global Configuration

Example

```
Enterprise AP(config)#radius-server port 181
Enterprise AP(config)#
```

radius-server key

This command sets the RADIUS encryption key.

- Syntax** `radius-server [secondary] key <key_string>`
- **secondary** - Secondary server.
 - *key_string* - Encryption key used to authenticate logon access for client. Do not use blank spaces in the string. (Maximum length: 20 characters)

Default Setting DEFAULT

Command Mode Global Configuration

Example

```
Enterprise AP(config)#radius-server key green
Enterprise AP(config)#
```

radius-server retransmit

This command sets the number of retries.

Syntax radius-server [secondary] retransmit *number_of_retries*

- **secondary** - Secondary server.
- *number_of_retries* - Number of times the BSAP-1600 will try to authenticate logon access via the RADIUS server. (Range: 1 - 30)

Default Setting 3

Command Mode Global Configuration

Example

```
Enterprise AP(config)#radius-server retransmit 5
Enterprise AP(config)#
```

radius-server timeout

This command sets the interval between transmitting authentication requests to the RADIUS server.

Syntax radius-server [secondary] timeout *number_of_seconds*

- **secondary** - Secondary server.
- *number_of_seconds* - Number of seconds the BSAP-1600 waits for a reply before resending a request. (Range: 1-60)

Default Setting 5

Command Mode Global Configuration

Example

```
Enterprise AP(config)#radius-server timeout 10
Enterprise AP(config)#
```

radius-server port-accounting

This command sets the RADIUS Accounting server network port.

Syntax radius-server [secondary] port-accounting *<port_number>*

- **secondary** - Secondary server. If **secondary** is not specified, then the BSAP-1600 assumes you are configuring the primary RADIUS server.
- *port_number* - RADIUS Accounting server UDP port used for accounting messages. (Range: 0 or 1024-65535)

Default Setting 0 (disabled)

Command Mode Global Configuration

Command Usage

- When the RADIUS Accounting server UDP port is specified, a RADIUS accounting session is automatically started for each user that is successfully authenticated to the BSAP-1600.

Example

```
Enterprise AP(config)#radius-server port-accounting 1813
Enterprise AP(config)#
```

radius-server timeout-interim

This command sets the interval between transmitting accounting updates to the RADIUS server.

Syntax radius-server [secondary] timeout-interim <number_of_seconds>

- **secondary** - Secondary server.
- **number_of_seconds** - Number of seconds the BSAP-1600 waits between transmitting accounting updates. (Range: 60-86400)

Default Setting 3600

Command Mode Global Configuration

Command Usage

- The BSAP-1600 sends periodic accounting updates after every interim period until the user logs off and a "stop" message is sent.

Example

```
Enterprise AP(config)#radius-server timeout-interim 500
Enterprise AP(config)#
```

radius-server radius-mac-format

This command sets the format for specifying MAC addresses on the RADIUS server.

Syntax radius-server radius-mac-format <multi-colon | multi-dash | no-delimiter | single-dash>

- **multi-colon** - Enter MAC addresses in the form xx:xx:xx:xx:xx:xx.
- **multi-dash** - Enter MAC addresses in the form xx-xx-xx-xx-xx-xx.
- **no-delimiter** - Enter MAC addresses in the form xxxxxxxxxxxx.
- **single-dash** - Enter MAC addresses in the form xxxxxx-xxxxxx.

Default Setting No delimiter

Command Mode Global Configuration

Example

```
Enterprise AP(config)#radius-server radius-mac-format multi-dash
Enterprise AP(config)#
```

radius-server vlan-format

This command sets the format for specifying VLAN IDs on the RADIUS server.

- Syntax** `radius-server vlan-format <hex | ascii>`
- **hex** - Enter VLAN IDs as a hexadecimal number.
 - **ascii** - Enter VLAN IDs as an ASCII string.

Default Setting Hex

Command Mode Global Configuration

Example

```
Enterprise AP(config)#radius-server vlan-format ascii
Enterprise AP(config)#
```

show radius

This command displays the current settings for the RADIUS server.

Default Setting None

Command Mode Exec

Example

```
Enterprise AP#show radius

Radius Server Information
=====
IP                : 0.0.0.0
Port              : 1812
Key               : *****
Retransmit        : 3
Timeout           : 5
Radius MAC format : no-delimiter
Radius VLAN format : HEX
=====

Radius Secondary Server Information
=====
IP                : 0.0.0.0
Port              : 1812
Key               : *****
Retransmit        : 3
Timeout           : 5
Radius MAC format : no-delimiter
Radius VLAN format : HEX
=====
Enterprise AP#
```

802.1X Authentication

The BSAP-1600 supports IEEE 802.1X access control for wireless clients. This control feature prevents unauthorized access to the network by requiring an 802.1X client application to submit user credentials for authentication. Client authentication is then verified by a RADIUS server using EAP (Extensible Authentication Protocol) before the BSAP-1600 grants client access to the network. The 802.1X EAP packets are also used to pass dynamic unicast session keys and static broadcast keys to wireless clients.

Table 7-14: 802.1X Authentication

Command	Function	Mode	Page
802.1x	Configures 802.1X as disabled, supported, or required	IC-W-VAP	7-55
802.1x broadcast-key-refresh-rate	Sets the interval at which the primary broadcast keys are refreshed for stations using 802.1X dynamic keying	IC-W-VAP	7-56
802.1x session-key refresh-rate	Sets the interval at which unicast session keys are refreshed for associated stations using dynamic keying	IC-W-VAP	7-56
802.1x session-timeout	Sets the timeout after which a connected client must be re-authenticated	IC-W-VAP	7-57
802.1x-suppliant enable	Enables the BSAP-1600 to operate as a 802.1X supplicant	GC	7-57
802.1x-suppliant user	Sets the supplicant user name and password for the BSAP-1600	GC	7-58
show authentication	Shows all 802.1X authentication settings, as well as the address filter table	Exec	7-58

802.1x

This command configures 802.1X as optionally supported or as required for wireless clients. Use the **no** form to disable 802.1X support.

Syntax 802.1x <supported | required>
no 802.1x

- **supported** - Authenticates clients that initiate the 802.1X authentication process. Uses standard 802.11 authentication for all others.
- **required** - Requires 802.1X authentication for all clients.

Default Setting Disabled

Command Mode Global Configuration

Command Usage

- When 802.1X is disabled, the BSAP-1600 does not support 802.1X authentication for any station. After successful 802.11 association, each client is allowed to access the network.
- When 802.1X is supported, the BSAP-1600 supports 802.1X authentication only for clients initiating the 802.1X authentication process (i.e., the BSAP-1600 does NOT initiate 802.1X authentication). For stations initiating 802.1X, only those stations successfully authenticated are allowed to access the network. For those stations not initiating 802.1X, access to the network is allowed after successful 802.11 association.
- When 802.1X is required, the BSAP-1600 enforces 802.1X authentication for all 802.11 associated stations. If 802.1X authentication is not initiated by the station, the BSAP-1600 will initiate authentication. Only those stations successfully authenticated with 802.1X are allowed to access the network.
- 802.1X does not apply to the 10/100Base-TX port.

Example

```
Enterprise AP(config)#802.1x supported
Enterprise AP(config)#
```

802.1x broadcast-key-refresh-rate

This command sets the interval at which the broadcast keys are refreshed for stations using 802.1X dynamic keying.

Syntax **802.1x broadcast-key-refresh-rate** <rate>

rate - The interval at which the BSAP-1600 rotates broadcast keys. (Range: 0 - 1440 minutes)

Default Setting 0 (Disabled)

Command Mode Global Configuration

Command Usage

- The BSAP-1600 uses Enterprise APOL (Extensible Authentication Protocol Over LANs) packets to pass dynamic unicast session and broadcast keys to wireless clients. The **802.1x broadcast-key-refresh-rate** command specifies the interval after which the broadcast keys are changed. The **802.1x session-key-refresh-rate** command specifies the interval after which unicast session keys are changed.
- Dynamic broadcast key rotation allows the BSAP-1600 to generate a random group key and periodically update all key-management capable wireless clients.

Example

```
Enterprise AP(config)#802.1X broadcast-key-refresh-rate 5
Enterprise AP(config)#
```

802.1x session-key-refresh-rate

This command sets the interval at which unicast session keys are refreshed for associated stations using dynamic keying.

Syntax 802.1x session-key-refresh-rate <rate>

rate - The interval at which the BSAP-1600 refreshes a session key. (Range: 0 - 1440 minutes)

Default Setting 0 (Disabled)

Command Mode Global Configuration

Command Usage Session keys are unique to each client, and are used to authenticate a client connection, and correlate traffic passing between a specific client and the BSAP-1600.

Example

```
Enterprise AP(config)#802.1x session-key-refresh-rate 5
Enterprise AP(config)#
```

802.1x session-timeout

This command sets the time period after which a connected client must be re-authenticated. Use the **no** form to disable 802.1X re-authentication.

Syntax 802.1x session-timeout <seconds>
no 802.1x session-timeout

seconds - The number of seconds. (Range: 0-65535)

Default 0 (Disabled)

Command Mode Global Configuration
Example

```
Enterprise AP(config)#802.1x session-timeout 300
Enterprise AP(config)#
```

802.1x-suppliant enable

This command enables the BSAP-1600 to operate as an 802.1X supplicant for authentication. Use the **no** form to disable 802.1X authentication of the BSAP-1600.

Syntax 802.1x-suppliant enable
no 802.1x-suppliant

Default Disabled

Command Mode Global Configuration

Command Usage A user name and password must be configured first before the 802.1X supplicant feature can be enabled.

Example

```
Enterprise AP(config)#802.1x-suppliant enable
Enterprise AP(config)#
```

802.1x-suppliant user

This command sets the user name and password used for authentication of the BSAP-1600 when operating as a 802.1X supplicant. Use the **no** form to clear the supplicant user name and password.

Syntax 802.1x-suppliant user <username> <password>
no 802.1x-suppliant user

- *username* - The BSAP-1600 name used for authentication to the network. (Range: 1-32 alphanumeric characters)
- *password* - The MD5 password used for BSAP-1600 authentication. (Range: 1-32 alphanumeric characters)

Default None

Command Mode Global Configuration

Command Usage The BSAP-1600 currently only supports EAP-MD5 CHAP for 802.1X supplicant authentication.

Example

```
Enterprise AP(config)#802.1x-suppliant user WA6102 dot1xpass
Enterprise AP(config)#
```

show authentication

This command shows all 802.1X authentication settings, as well as the address filter table.

Command Mode Exec

Example

```
Enterprise AP#show authentication

Authentication Information
=====
MAC Authentication Server      : DISABLED
MAC Auth Session Timeout Value : 0 min
802.1x supplicant             : DISABLED
802.1x supplicant user        : EMPTY
802.1x supplicant password    : EMPTY
Address Filtering              : ALLOWED

System Default : ALLOW addresses not found in filter table.
Filter Table

MAC Address                Status
-----
00-70-50-cc-99-1a         DENIED
00-70-50-cc-99-1b         ALLOWED
=====
Enterprise AP(config)#
```

MAC Address Authentication

Use these commands to define MAC authentication on the BSAP-1600. For local MAC authentication, first define the default filtering policy using the address filter default command. Then enter the MAC addresses to be filtered, indicating if they are allowed or denied. For RADIUS MAC authentication, the MAC addresses and filtering policy must be configured on the RADIUS server.

Table 7-15: MAC Address Authentication

Command	Function	Mode	Page
address filter default	Sets filtering to allow or deny listed addresses	GC	7-59
address filter entry	Enters a MAC address in the filter table	GC	7-60
address filter delete	Removes a MAC address from the filter table	GC	7-60
mac- authentication server	Sets address filtering to be performed with local or remote options	GC	7-60
mac- authentication session-timeout	Sets the interval at which associated clients will be re-authenticated with the RADIUS server authentication database	GC	7-61
show authentication	Shows all 802.1X authentication settings, as well as the address filter table	Exec	7-58

address filter default

This command sets filtering to allow or deny listed MAC addresses.

Syntax address filter default <allowed | denied>

- **allowed** - Only MAC addresses entered as “denied” in the address filtering table are denied.
- **denied** - Only MAC addresses entered as “allowed” in the address filtering table are allowed.

Default allowed

Command Mode Global Configuration

Example

```
Enterprise AP(config)#address filter default denied
Enterprise AP(config)#
```

Related Commands address filter entry

address filter entry

This command enters a MAC address in the filter table.

Syntax `address filter entry <mac-address> <allowed | denied>`

- *mac-address* - Physical address of client. (Enter six pairs of hexadecimal digits separated by hyphens; e.g., 00-90-D1-12-AB-89.)
- **allowed** - Entry is allowed access.
- **denied** - Entry is denied access.

Default None

Command Mode Global Configuration

- Command Mode**
- The BSAP-1600 supports up to 1024 MAC addresses.
 - An entry in the address table may be allowed or denied access depending on the global setting configured for the **address entry default** command.

Example

```
Enterprise AP(config)#address filter entry 00-70-50-cc-991a allowed
Enterprise AP(config)#
```

Related Commands address filter default

address filter delete

This command deletes a MAC address from the filter table.

Syntax `address filter delete <mac-address>`

mac-address - Physical address of client. (Enter six pairs of hexadecimal digits separated by hyphens.)

Default None

Command Mode Global Configuration

Example

```
Enterprise AP(config)#address filter delete 00-70-50-cc-991b
Enterprise AP(config)#
```

Related Commands 802.1x-suppliant user

mac-authentication server

This command sets address filtering to be performed with local or remote options. Use the **no** form to disable MAC address authentication.

Syntax `mac-authentication server [local | remote]`

- **local** - Authenticate the MAC address of wireless clients with the local authentication database during 802.11 association.
- **remote** - Authenticate the MAC address of wireless clients with the RADIUS server during 802.1X authentication.

Default Disabled

Command Mode Global Configuration

Example

```
Enterprise AP(config)#mac-authentication server remote
Enterprise AP(config)#
```

Related Commands address filter entry 802.1x-supplicant user

mac-authentication session-timeout

This command sets the interval at which associated clients will be re-authenticated with the RADIUS server authentication database. Use the **no** form to disable reauthentication.

Syntax **mac-authentication session-timeout** <minutes>
 minutes - Re-authentication interval. (Range: 0-1440)

Default 0 (disabled)

Command Mode Global Configuration

Example

```
Enterprise AP(config)#mac-authentication session-timeout 1
Enterprise AP(config)#
```

Filtering Commands

The commands described in this section are used to filter communications between wireless clients, control access to the management interface from wireless clients, and filter traffic using specific Ethernet protocol types.

Table 7-16: Filtering Commands

Command	Function	Mode	Page
filter local-bridge	Disables communication between wireless clients	GC	7-62
filter ap-manage	Prevents wireless clients from accessing the management interface	GC	7-63
filter uplink enable	Ethernet port MAC address filtering	GC	7-63
filter uplink	Adds or deletes a MAC address from the filtering table	GC	7-63
filter ethernet-type enable	Checks the Ethernet type for all incoming and outgoing Ethernet packets against the protocol filtering table	GC	7-63
filter ethernet-type protocol	Sets a filter for a specific Ethernet type	GC	7-64
show filters	Shows the filter configuration	Exec	7-64

filter local-bridge

This command disables communication between wireless clients. Use the **no** form to disable this filtering.

Syntax filter local-bridge <all-VAP / intra-VAP>
no filter local-bridge

all-VAP - When enabled, clients cannot establish wireless communications with any other client, either those associated to the same VAP interface or any other VAP interface.

intra-VAP - When enabled, clients associated with a specific VAP interface cannot establish wireless communications with each other. Clients can communicate with clients associated to other VAP interfaces.

Default Disabled

Command Mode Global Configuration

Command Usage This command can disable wireless-to-wireless communications between clients via the BSAP-1600. However, it does not affect communications between wireless clients and the wired network.

Example

```
Enterprise AP(config)#filter local-bridge
Enterprise AP(config)#
```

filter ap-manage

This command prevents wireless clients from accessing the management interface on the BSAP-1600. Use the **no** form to disable this filtering.

Syntax filter ap-manage
no filter ap-manage

Default Enabled

Command Mode Global Configuration

Example

```
Enterprise AP(config)#filter AP-manage
Enterprise AP(config)#
```

filter uplink enable

This command enables filtering of MAC addresses from the Ethernet port.

Syntax [no] filter uplink enable

Default Disabled

Command Mode Global Configuration

Example

```
Enterprise AP(config)#filter uplink enable
Enterprise AP(config)#
```

filter uplink

This command adds or deletes MAC addresses from the uplink filtering table.

Syntax filter uplink <add / delete> *MAC address*
MAC address - Specifies a MAC address in the form xx-xx-xx-xx-xx-xx.
A maximum of four addresses can be added to the filtering table.

Default Disabled

Command Mode Global Configuration

Example

```
Enterprise AP(config)#filter uplink add 00-12-34-56-78-9a
Enterprise AP(config)#
```

filter ethernet-type enable

This command checks the Ethernet type on all incoming and outgoing Ethernet packets against the protocol filtering table. Use the **no** form to disable this feature.

Syntax filter ethernet-type enable
no filter ethernet-type enable

Default Disabled

Command Mode Global Configuration

Command Usage This command is used in conjunction with the **filter ethernet-type protocol** command to determine which Ethernet protocol types are to be filtered.

Example

```
Enterprise AP(config)#filter ethernet-type enable
Enterprise AP(config)#
```

Related Commands filter ethernet-type protocol

filter ethernet-type protocol

This command sets a filter for a specific Ethernet type. Use the **no** form to disable filtering for a specific Ethernet type.

Syntax filter ethernet-type protocol <protocol>
no filter ethernet-type protocol <protocol>

protocol - An Ethernet protocol type. (Options: ARP, RARP, Berkeley-Trailer-Negotiation, LAN-Test, X25-Level-3, Banyan, CDP, DEC XNS, DEC-MOP-Dump-Load, DEC-MOP, DEC-LAT, Ethertalk, Appletalk-ARP, Novell-IPX(old), Novell-IPX(new), EAPOL, Telxon-TXP, Aironet-DDP, Enet-Config-Test, IP, IPv6, NetBEUI, PPPoE_Discovery, PPPoE_PPP_Session)

Default None

Command Mode Global Configuration

Command Usage Use the **filter ethernet-type enable** command to enable filtering for Ethernet types specified in the filtering table, or the **no filter ethernet-type enable** command to disable all filtering based on the filtering table.

Example

```
Enterprise AP(config)#filter ethernet-type protocol ARP
Enterprise AP(config)#
```

Related Commands filter ethernet-type enable

show filters

This command shows the filter options and protocol entries in the filter table.

Command Mode Exec

Example

```

Enterprise AP#show filters
Protocol Filter Information
=====
Local Bridge           :Traffic among all client STAs blocked
AP Management          :ENABLED
Ethernet Type Filter   :DISABLED

Uplink Access Table
-----
Uplink access control:Enabled
Uplink MAC access control list      :
00-12-34-56-78-9a
-----
Enabled Protocol Filters
-----
No protocol filters are enabled
=====
Enterprise AP#

```

WDS Bridge Commands

The commands described in this section are used to set the operation mode for each BSAP-1600 interface and configure Wireless Distribution System (WDS) forwarding table settings.

Table 7-17: WDS Bridge Commands

Command	Function	Mode	Page
wds mode	Sets the mode of operation for bridge communications	GC	7-66
bridge mode	Selects Master or Slave mode.	IC-W	7-66
bridge role	Selects the bridge operation mode for a radio interface	IC-W	7-66
bridge channel-auto-sync	Automatically finds the parent bridge operating channel	IC-W	7-67
bridge-link parent	Configures the MAC addresses of the parent bridge node	IC-W	7-67
bridge-link child	Configures MAC addresses of connected child bridge nodes	IC-W	7-67
bridge dynamic-entry age-time	Sets the aging time for dynamic entries in the WDS forwarding table	GC	7-68
show bridge aging-time	Displays the current WDS forwarding table aging time	Exec	7-68
show bridge filter-entry	Displays current entries in the bridge MAC address table	Exec	7-69
show bridge link	Current bridge settings for specified interfaces	Exec	7-69

bridge mode

This command selects between Master and Slave mode.

Syntax `bridge mode <master | slave>`

- **master** - Operates as a master enabling up to five slave links.
- **slave** - Operates as a slave (node) with only one link to the master.

Default Setting Slave

Command Mode Interface Configuration (Wireless)

Example

```
Enterprise AP(if-wireless a)#bridge mode master
Enterprise AP(if-wireless a)#
```

bridge role (WDS)

This command selects the bridge operation mode for the radio interface.

Syntax `bridge role <ap | repeater | bridge | root-bridge>`

- **ap** - Operates only as an access point for wireless clients.
- **repeater** - Operates as a wireless repeater, extending the range for remote wireless clients and connecting them to the root bridge. The "Parent" link to the root bridge must be configured. In this mode, traffic is not forwarded to the Ethernet port from the radio interface.
- **bridge** - Operates as a bridge to other BSAP-1600s also in bridge mode.
- **root-bridge** - Operates as the root bridge in the bridge link network.

Default Setting AP

Command Mode Interface Configuration (Wireless)

- Command Usage**
- When the bridge role is set to "repeater," the "Parent" link to the root bridge must be configured (See "bridge-link parent" on page 7-67.). When the BSAP-1600 is operating in this mode, traffic is not forwarded to the Ethernet port from the radio interface.
 - Up to four WDS bridge links (MAC addresses) per radio interface can be specified for each BSAP-1600 in the bridge link network. One BSAP-1600 only must be configured as the "root bridge" in the wireless network. The root bridge is the BSAP-1600 connected to the main core of the wired LAN. Other bridges need to specify one "Parent" link to the root bridge or to a bridge connected to the root bridge. The other seven WDS links are available as "Child" links to other bridges.
 - The bridge link on the radio interface always uses the default VAP interface. In any bridge mode, VAP interfaces 1 to 7 are not available for use.

Example

```
Enterprise AP(if-wireless a)#bridge role root-bridge
Enterprise AP(if-wireless a)#
```

bridge channel-auto-sync

This command allows a child bridge to automatically find the operating channel of its parent bridge.

Syntax `bridge channel-auto-sync <enable | disable>`

- **enable** - The bridge will automatically search and find the operating channel of its parent.
- **disable** - The bridge must have the operating channel manually set to the operating channel of its parent bridge.

Default Setting Disabled

Command Mode Interface Configuration (Wireless)

Example

```
Enterprise AP(if-wireless a)#bridge channel-auto-sync enable
Enable channel auto sync!!
Enterprise AP(if-wireless a)#
```

bridge-link parent

This command configures the MAC address of the parent bridge node.

Syntax `bridge-link parent <mac-address>`

mac-address - The wireless MAC address of the parent BSAP-1600. (12 hexadecimal digits in the form "xx-xx-xx-xx-xx-xx").

Default Setting None

Command Mode Interface Configuration (Wireless)

Command Usage Every bridge (except the root bridge) in the bridge link network must specify the MAC address of the parent bridge that is linked to the root bridge, or the root bridge itself.

Example

```
Enterprise AP(if-wireless a)#bridge-link parent 00-08-2d-69-3a-51
Enterprise AP(if-wireless a)#
```

bridge-link child

This command configures the MAC addresses of child bridge nodes.

Syntax `bridge-link child <index> <mac-address>`

- *index* - The link index number of the child node. (Range: 1 - 6)

- *mac-address* - The wireless MAC address of a child BSAP-1600. (12 hexadecimal digits in the form "xx-xx-xx-xx-xx-xx").

Default Setting None

Command Mode Interface Configuration (Wireless)

Command Usage

- In root bridge mode, up to six child bridge links can be specified using link index numbers 1 to 6.
- In bridge mode, up to five child links can be specified using link index numbers 2 to 6. Index number 1 is reserved for the parent link, which must be set using the **bridge parent** command.

Example

```
Enterprise AP(if-wireless a)#bridge-link child 2 00-08-3e-84-bc-6d
Enterprise AP(if-wireless a)#bridge-link child 3 00-08-3e-85-13-f2
Enterprise AP(if-wireless a)#bridge-link child 4 00-08-3e-84-79-31
Enterprise AP(if-wireless a)#
```

bridge dynamic-entry age-time

This command sets the time for aging out dynamic entries in the WDS forwarding table.

Syntax **bridge dynamic-entry age-time** <*seconds*>
seconds - The time to age out an address entry. (Range: 10-10000 seconds).

Default Setting 300 seconds

Command Mode Global Configuration

Command Usage If the MAC address of an entry in the address table is not seen on the associated interface for longer than the aging time, the entry is discarded.

Example

```
Enterprise AP(config)#bridge dynamic-entry age-time 100
Enterprise AP(config)#
```

show bridge aging-time

This command displays the current WDS forwarding table aging time setting.

Command Mode Exec

Example

```
Enterprise AP#show bridge aging-time
Aging time: 300
Enterprise AP#
```

show bridge filter-entry

This command displays current entries in the WDS forwarding table.

Command Mode Exec

Example

```
Enterprise AP#show bridge filter-entry

max entry numbers =512
current entry nums =13
*****
***** Bridge MAC Addr Table *****
*****
|          MAC          | Port | Fwd_type| VlanID|origin life|remain Life| Type |
01 80 c2 00 00 00      | 0    | 5       | 4095  | 300      | 300      | Static
01 80 c2 00 00 03      | 0    | 5       | 4095  | 300      | 300      | Static
00 30 f1 f0 9b 20      | 1    | 0       | 1     | 300      | 300      | Static
00 30 f1 f0 9b 21      | 1    | 0       | 1     | 300      | 300      | Static
00 30 f1 f0 9b 22      | 1    | 0       | 1     | 300      | 300      | Static
00 30 f1 f0 9b 23      | 1    | 0       | 1     | 300      | 300      | Static
00 30 f1 f0 9b 24      | 1    | 0       | 1     | 300      | 300      | Static
00 30 f1 f0 9b 25      | 1    | 0       | 1     | 300      | 300      | Static
00 30 f1 f0 9b 26      | 1    | 0       | 1     | 300      | 300      | Static
00 30 f1 f0 9b 27      | 1    | 0       | 1     | 300      | 300      | Static
00 30 f1 2f be 30      | 1    | 3       | 0     | 300      | 175     | Dynamic
00 30 f1 f0 9a 9c      | 1    | 0       | 1     | 300      | 300      | Static
ff ff ff ff ff ff     | 0    | 4       | 4095  | 300      | 300      | Static
Enterprise AP#
```

show bridge link

This command displays WDS bridge link and spanning tree settings for specified interfaces.

Syntax show bridge link <ethernet | wireless <a | g> [*index*]>

- **ethernet** - Specifies the Ethernet interface.
- **wireless** - Specifies a wireless interface.
- **a** - The 802.11a radio interface.
- **g** - The 802.11g radio interface.
- **index** - The index number of a bridge link. (Range: 1 - 6)

Command Mode Exec

Example

```
Enterprise AP#show bridge link wireless a

Interface Wireless A WDS Information
=====
AP Role:      Bridge
Channel Auto Sync:  Disable
Parent:      00-12-34-56-78-9a
```

```
Child:
  Child 2: 00-08-12-34-56-de
  Child 3: 00-00-00-00-00-00
  Child 4: 00-00-00-00-00-00
  Child 5: 00-00-00-00-00-00
  Child 6: 00-00-00-00-00-00
```

```
STAs:
  No WDS Stations.
```

```
Enterprise AP#
```

```
Enterprise AP#show bridge link wireless a 2
```

```
Port-No          : 11
status           : Enabled
state            : Disabled
priority         : 0
path cost        : 19
message age Timer : Inactive
message age      : 4469
designated-root   : priority = 32768, MAC = 00:30:F1:F0:9A:9C
designated-cost   : 0
designated-bridge : priority = 32768, MAC = 00:30:F1:F0:9A:9C
designated-port   : priority = 0, port No = 11
forward-transitions : 0
Enterprise AP#
```

```
Enterprise AP#show bridge link ethernet
```

```
status           : Enabled
state            : Forwarding
priority         : 0
path cost        : 19
message age Timer : Inactive
message age      : 4346
designated-root   : priority = 32768, MAC = 00:30:F1:F0:9A:9C
designated-cost   : 0
designated-bridge : priority = 32768, MAC = 00:30:F1:F0:9A:9C
designated-port   : priority = 0, port No = 1
forward-transitions : 1
Enterprise AP#
```

Spanning Tree Commands

The commands described in this section are used to set the MAC address table aging time and spanning tree parameters for both the Ethernet and wireless interfaces.

Table 7-18: Spanning Tree Commands

Command	Function	Mode	Page
bridge stp enable	Enables the Spanning Tree feature	GC	7-71
bridge stp forwarding-delay	Configures the spanning tree bridge forward time	GC	7-71
bridge stp hello-time	Configures the spanning tree bridge hello time	GC	7-72
bridge stp max-age	Configures the spanning tree bridge maximum age	GC	7-72
bridge stp priority	Configures the spanning tree bridge priority	GC	7-73
bridge-link path-cost	Configures the spanning tree path cost of a port	IC	7-73
bridge-link port-priority	Configures the spanning tree priority of a port	IC	7-74
show bridge stp	Displays the global spanning tree settings	Exec	7-74
show bridge link	Displays current bridge settings for specified interfaces	Exec	7-69

bridge stp enable

This command enables the Spanning Tree Protocol. Use the **no** form to disable the Spanning Tree Protocol.

Syntax bridge stp enable
no bridge stp enable

Default Setting Enabled

Command Mode Global Configuration

Example This example globally enables the Spanning Tree Protocol.

```
Enterprise AP(config)#bridge stp enable
Enterprise AP(config)
```

bridge stp forwarding-delay

Use this command to configure the spanning tree bridge forward time globally for the BSAP-1600. Use the **no** form to restore the default.

Syntax bridge stp forwarding-delay <seconds>

no bridge stp forwarding-delay

seconds - Time in seconds. (Range: 4 - 30 seconds)

The minimum value is the higher of 4 or $[(\text{max-age} / 2) + 1]$.

Default Setting 15 seconds

Command Mode Global Configuration

Command Usage This command sets the maximum time (in seconds) the root device will wait before changing states (i.e., discarding to learning to forwarding). This delay is required because every device must receive information about topology changes before it starts to forward frames. In addition, each port needs time to listen for conflicting information that would make it return to the discarding state; otherwise, temporary data loops might result.

Example

```
Enterprise AP(config)#bridge stp forwarding-delay 20
Enterprise AP(config)#
```

bridge stp hello-time

Use this command to configure the spanning tree bridge hello time globally for the BSAP-1600. Use the **no** form to restore the default.

Syntax **bridge stp hello-time** <*time*>

no bridge stp hello-time

time - Time in seconds. (Range: 1-10 seconds).

The maximum value is the lower of 10 or $[(\text{max-age} / 2) - 1]$.

Default Setting 2 seconds

Command Mode Global Configuration

Command Usage This command sets the time interval (in seconds) at which the root device transmits a configuration message.

Example

```
Enterprise AP(config)#bridge stp hello-time 5
Enterprise AP(config)#
```

bridge stp max-age

Use this command to configure the spanning tree bridge maximum age globally for the BSAP-1600. Use the **no** form to restore the default.

Syntax **bridge stp max-age** <*seconds*>

no bridge stp max-age

seconds - Time in seconds. (Range: 6-40 seconds)

The minimum value is the higher of 6 or $[2 \times (\text{hello-time} + 1)]$.

The maximum value is the lower of 40 or $[2 \times (\text{forward-time} - 1)]$.

Default Setting 20 seconds

Command Mode Global Configuration

Command Usage This command sets the maximum time (in seconds) a device can wait without receiving a configuration message before attempting to reconfigure. All device ports (except for designated ports) should receive configuration messages at regular intervals. Any port that ages out STP information (provided in the last configuration message) becomes the designated port for the attached LAN. If it is a root port, a new root port is selected from among the device ports attached to the network.

Example

```
Enterprise AP(config)#bridge stp max-age 40
Enterprise AP(config)#
```

bridge stp priority

Use this command to configure the spanning tree priority globally for the BSAP-1600. Use the **no** form to restore the default.

Syntax **bridge stp priority**<priority>

no bridge stp priority

priority - Priority of the bridge. (Range: 0 - 65535)

Default Setting 32768

Command Mode Global Configuration

Command Usage Bridge priority is used in selecting the root device, root port, and designated port. The device with the highest priority becomes the STP root device. However, if all devices have the same priority, the device with the lowest MAC address will then become the root device.

Example

```
Enterprise AP(config)#bridge stp-bridge priority 40000
Enterprise AP(config)#
```

bridge-link path-cost

Use this command to configure the spanning tree path cost for the specified port.

Syntax **bridge-link path-cost** <index> <cost>

- *index* - Specifies the bridge link number on the BSAP-1600. (Range: 1-6 required on wireless interface only)
- *cost* - The path cost for the port. (Range: 1-65535)

Default Setting 19

Command Mode Interface Configuration

- Command Usage**
- This command is used by the Spanning Tree Protocol to determine the best path between devices. Therefore, lower values should be assigned to ports attached to faster media, and higher values assigned to ports with slower media.
 - Path cost takes precedence over port priority.

Example

```
Enterprise AP(if-wireless a)#bridge-link path-cost 1 50
Enterprise AP(if-wireless a)#
```

bridge-link port-priority

Use this command to configure the priority for the specified port.

Syntax `bridge-link port-priority <index> <priority>`

- *index* - Specifies the bridge link number on the BSAP-1600. (Range: 1-6 required on wireless interface only)
- *priority* - The priority for a port. (Range: 1-255)

Default Setting 128

Command Mode Interface Configuration

- Command Usage**
- This command defines the priority for the use of a port in the Spanning Tree Protocol. If the path cost for all ports on a BSAP-1600 are the same, the port with the highest priority (that is, lowest value) will be configured as an active link in the spanning tree.
 - Where more than one port is assigned the highest priority, the port with lowest numeric identifier will be enabled.

Example

```
Enterprise AP(if-wireless a)#bridge-link port-priority 1 64
Enterprise AP(if-wireless a)#
```

Related Commands bridge-link path-cost

show bridge stp

Displays aging time and spanning tree settings for the Ethernet and wireless interfaces.

Syntax `show bridge stp`

Command Mode Exec

Example

```

Enterprise AP#show bridge stp
Bridge MAC          : 00:12:CF:05:B7:84
Status              : Disabled
priority            : 0
designated-root      : priority = 0, MAC = 00:00:00:00:00:00
root-path-cost      : 0
root-Port-no       : 0
Hold Time           :      1 Seconds
Hello Time          :      2 Seconds
Maximum Age         :      20 Seconds
Forward Delay       :      15 Seconds
bridge Hello Time   :      2 Seconds
bridge Maximum Age  :      20 Seconds
bridge Forward Delay :      15 Seconds
time-since-top-change: 89185 Seconds
topology-change-count: 0
Enterprise AP#

```

Ethernet Interface Commands

Configure connection parameters for the Ethernet port and wireless interface.

Table 7-19: Ethernet Interface Commands

Command	Function	Mode	Page
interface ethernet	Enters Ethernet interface configuration mode	GC	7-75
dns primary- server	Specifies the primary name server	IC-E	7-76
dns secondary- server	Specifies the secondary name server	IC-E	7-76
ip address	Sets the IP address for the Ethernet interface	IC-E	7-76
ip dhcp	Submits a DHCP request for an IP address	IC-E	7-77
speed-duplex	Configures speed & duplex operation on the Ethernet interface.	IC-E	7-77
shutdown	Disables the Ethernet interface	IC-E	7-78
show interface ethernet	Shows the status for the Ethernet interface	Exec	7-78

interface ethernet

This command enters Ethernet interface configuration mode.

Default Setting None

Command Mode Global Configuration

Example To specify the 10/100Base-TX network interface, enter the following command:

```

Enterprise AP(config)#interface ethernet
Enterprise AP(if-ethernet)#

```

dns server

This command specifies the address for the primary or secondary domain name server to be used for name-to-address resolution.

Syntax `dns primary-server <server-address>`
`dns secondary-server <server-address>`

- **primary-server** - Primary server used for name resolution.
- **secondary-server** - Secondary server used for name resolution.
- *server-address* - IP address of domain-name server.

Default Setting None

Command Mode Global Configuration

Command Usage The primary and secondary name servers are queried in sequence.

Example This example specifies two domain-name servers.

```
Enterprise AP(if-ethernet)#dns primary-server 192.168.1.55
Enterprise AP(if-ethernet)#dns secondary-server 10.1.0.55
Enterprise AP(if-ethernet)#
```

Related Commands show interface ethernet

ip address

This command sets the IP address for the BSAP-1600. Use the **no** form to restore the default IP address.

Syntax `ip address <ip-address> <netmask> <gateway>`
`no ip address`

- *ip-address* - IP address
- *netmask* - Network mask for the associated IP subnet. This mask identifies the host address bits used for routing to specific subnets.
- *gateway* - IP address of the default gateway

Default Setting IP address: 192.168.1.1
Netmask: 255.255.255.0

Command Mode Interface Configuration (Ethernet)

Command Usage

- DHCP is enabled by default. To manually configure a new IP address, you must first disable the DHCP client with the **no ip dhcp** command.
- You must assign an IP address to this device to gain management access over the network or to connect the BSAP-1600 to existing IP subnets. You can manually configure a specific IP address using this command, or direct the device to obtain an address from a DHCP server using the **ip dhcp** command. Valid IP addresses consist of four numbers, 0 to 255, separated by periods. Anything outside this format will not be accepted by the configuration program.

Example

```
Enterprise AP(config)#interface ethernet
Enter Ethernet configuration commands, one per line.
Enterprise AP(if-ethernet)#ip address 192.168.1.2 255.255.255.0 192.168.1.253
Enterprise AP(if-ethernet)#
```

Related Commands ip dhcp

ip dhcp

This command enables the BSAP-1600 to obtain an IP address from a DHCP server. Use the **no** form to restore the default IP address.

Syntax ip dhcp
no ip dhcp

Default Setting Enabled

Command Mode Interface Configuration (Ethernet)

Command Usage

- You must assign an IP address to this device to gain management access over the network or to connect the BSAP-1600 to existing IP subnets. You can manually configure a specific IP address using the **ip address** command, or direct the device to obtain an address from a DHCP server using this command.
- When you use this command, the BSAP-1600 will begin broadcasting DHCP client requests. The current IP address (i.e., default or manually configured address) will continue to be effective until a DHCP reply is received. Requests will be broadcast periodically by this device in an effort to learn its IP address. (DHCP values can include the IP address, subnet mask, and default gateway.)

Example

```
Enterprise AP(config)#interface ethernet
Enter Ethernet configuration commands, one per line.
Enterprise AP(if-ethernet)#ip dhcp
Enterprise AP(if-ethernet)#
```

Related Commands ip address

speed-duplex

This command configures the speed and duplex mode of a given interface when autonegotiation is disabled. Use the **no** form to restore the default.

Syntax speed-duplex <auto | 10MH | 10MF | 100MF | 100MH>

- **auto** - autonegotiate speed and duplex mode
- **10MH** - Forces 10 Mbps, half-duplex operation
- **10MF** - Forces 10 Mbps, full-duplex operation
- **100MH** - Forces 100 Mbps, half-duplex operation
- **100MF** - Forces 100 Mbps, full-duplex operation

Default Setting Auto-negotiation is enabled by default.

Command Mode Interface Configuration (Ethernet)

Command Usage If autonegotiation is disabled, the speed and duplex mode must be configured to match the setting of the attached device.

Example The following example configures the Ethernet port to 100 Mbps, full-duplex operation.

```
Enterprise AP(if-ethernet)#speed-duplex 100mf
Enterprise AP(if-ethernet)#
```

shutdown

This command disables the Ethernet interface. To restart a disabled interface, use the **no** form.

Syntax shutdown
no shutdown

Default Setting Interface enabled

Command Mode Interface Configuration (Ethernet)

Command Usage This command allows you to disable the Ethernet port due to abnormal behavior (e.g., excessive collisions), and reenables it after the problem has been resolved. You may also want to disable the Ethernet port for security reasons.

Example The following example disables the Ethernet port.

```
Enterprise AP(if-ethernet)#shutdown
Enterprise AP(if-ethernet)#
```

show interface ethernet

This command displays the status for the Ethernet interface.

Syntax show interface [ethernet]

Default Setting Ethernet interface

Command Mode Exec

Example

```

Enterprise AP#show interface ethernet
Ethernet Interface Information
=====
IP Address       : 192.168.1.1
Subnet Mask     : 255.255.255.0
Default Gateway : 192.168.1.253
Primary DNS     : 192.168.1.55
Secondary DNS   : 10.1.0.55
Speed-duplex    : 100Base-TX Half Duplex
Admin status    : Up
Operational status : Up
=====
Enterprise AP#

```

Wireless Interface Commands

The commands described in this section configure connection parameters for the wireless interfaces.

Table 7-20: Wireless Interface Commands

Command	Function	Mode	Page
interface wireless	Enters wireless interface configuration mode	GC	7-80
vap	Provides access to the VAP interface configuration mode	IC-W	7-81
speed	Configures the maximum data rate at which the BSAP-1600 transmits unicast packets	IC-W	7-81
turbo	Configures turbo mode to use a faster data rate	IC-W (a)	7-82
multicast-data-rate	Configures the maximum rate for transmitting multicast packets on the wireless interface	IC-W	7-82
channel	Configures the radio channel	IC-W	7-83
transmit-power	Adjusts the power of the radio signals transmitted from the BSAP-1600	IC-W	7-83
radio-mode	Forces the operating mode of the 802.11g radio	IC-W (b/g)	7-84
preamble	Sets the length of the 802.11g signal preamble	IC-W (b/g)	7-84
antenna control	Selects the antenna control method to use for the radio	IC-W	7-85
antenna id	Selects the antenna ID to use for the radio	IC-W	7-85
antenna location	Selects the location of the antenna	IC-W	7-86
beacon-interval	Configures the rate at which beacon signals are transmitted from the BSAP-1600	IC-W	7-86
dtim-period	Configures the rate at which stations in sleep mode must wake up to receive broadcast/multicast transmissions	IC-W	7-87

Table 7-20: Wireless Interface Commands

fragmentation-length	Configures the minimum packet size that can be fragmented	IC-W	7-87
rts-threshold	Sets the packet size threshold at which an RTS must be sent to the receiving station prior to the sending station starting communications	IC-W	7-88
super-a	Enables Atheros proprietary Super A performance enhancements	IC-W (a)	7-88
super-g	Enables Atheros proprietary Super G performance enhancements	IC-W (b/g)	7-89
description	Adds a description to the wireless interface	IC-W-VAP	7-89
ssid	Configures the service set identifier	IC-W-VAP	7-89
closed system	Opens access to clients without a pre-configured SSID	IC-W-VAP	7-90
max-association	Configures the maximum number of clients that can be associated with the BSAP-1600 at the same time	IC-W-VAP	7-90
assoc-timeout-interval	Configures the idle time interval (when no frames are sent) after which a client is disassociated from the VAP interface	IC-W-VAP	7-90
auth-timeout-value	Configures the time interval after which clients must be re-authenticated	IC-W-VAP	7-91
shutdown	Disables the wireless interface	IC-W-VAP	7-91
show interface wireless	Shows the status for the wireless interface	Exec	7-91
show station	Shows the wireless clients associated with the BSAP-1600	Exec	7-94

interface wireless

This command enters wireless interface configuration mode.

Syntax `interface wireless <a | g>`

- **a** - 802.11a radio interface.
- **g** - 802.11g radio interface.

Default Setting None

Command Mode Global Configuration

Example To specify the 802.11a interface, enter the following command:

```
Enterprise AP(config)#interface wireless a
Enterprise AP(if-wireless a)#
```

vap

This command provides access to the VAP (Virtual Access Point) interface configuration mode.

Syntax `vap <vap-id>`

vap-id - The number that identifies the VAP interface. (Options: 0-3)

Default Setting None

Command Mode Interface Configuration (Wireless)

Example

```
Enterprise AP(if-wireless g)#vap 0
Enterprise AP(if-wireless g: VAP[0])#
```

speed

This command configures the maximum data rate at which the BSAP-1600 transmits unicast packets.

Syntax `speed <speed>`

speed - Maximum access speed allowed for wireless clients. (Options for 802.11a: 6, 9, 12, 18, 24, 36, 48, 54 Mbps) (Options for 802.11b/g: 1, 2, 5.5, 6, 9, 11, 12, 18, 24, 36, 48, 54 Mbps)

Default Setting 54 Mbps

Command Mode Interface Configuration (Wireless)

Command Usage

- The maximum transmission distance is affected by the data rate. The lower the data rate, the longer the transmission distance. Please refer to the table for maximum distances in "Operating Range" on page C-5.
- When turbo mode is enabled (ssid) for 802.11a, the effective maximum speed specified by this command is double the entered value (e.g., setting the speed to 54 Mbps limits the effective maximum speed to 108 Mbps).

Example

```
Enterprise AP(if-wireless g)#speed 6
Enterprise AP(if-wireless g)#
```

turbo

This command sets the BSAP-1600 to an enhanced proprietary modulation mode (not regulated in IEEE 802.11a) that provides a higher data rate of up to 108 Mbps.

Syntax turbo <static | dynamic>
no turbo

static - Always uses turbo mode.

dynamic - Will use turbo mode when no other nearby BSAP-1600s are detected or active.

Default Setting Disabled

Command Mode Interface Configuration (Wireless - 802.11a)

- Command Usage**
- The normal 802.11a wireless operation mode provides connections up to 54 Mbps. Turbo Mode is an enhanced mode (not regulated in IEEE 802.11a) that provides a higher data rate of up to 108 Mbps. Enabling Turbo Mode allows the BSAP-1600 to provide connections up to 108 Mbps.
 - In normal mode, the BSAP-1600 provides a channel bandwidth of 20 MHz, and supports the maximum number of channels permitted by local regulations (e.g., 11 channels for the United States). In Turbo Mode, the channel bandwidth is increased to 40 MHz to support the increased data rate. However, this reduces the number of channels supported (e.g., 5 channels for the United States).

Example

```
Enterprise AP(if-wireless a)#turbo
Enterprise AP(if-wireless a)#
```

multicast-data-rate

This command configures the maximum data rate at which the BSAP-1600 transmits multicast and management packets (excluding beacon packets) on the wireless interface.

Syntax multicast-data-rate <speed>

speed - Maximum transmit speed allowed for multicast data. (Options for 802.11a: 6, 12, 24 Mbps)

(Options for 802.11b/g: 1, 2, 5.5, 11 Mbps)

Default Setting 1 Mbps for 802.11b/g
6 Mbps for 802.11a

Command Mode Interface Configuration (Wireless)

Example

```
Enterprise AP(if-wireless g)#multicast-data-rate 5.5
Enterprise AP(if-wireless g)#
```

channel

This command configures the radio channel through which the BSAP-1600 communicates with wireless clients.

Syntax `channel <channel | auto>`

- *channel* - Manually sets the radio channel used for communications with wireless clients. (Range for 802.11a: 36, 40, 44, 48, 52, 56, 60, 64, 149, 153, 157, 161, 165 for normal mode, and 42, 50, 58, 152, 160 for turbo mode; Range for 802.11b/g: 1 to 14)
- **auto** - Automatically selects an unoccupied channel (if available). Otherwise, the lowest channel is selected.

Default Setting Automatic channel selection

Command Mode Interface Configuration (Wireless)

- Command Usage**
- The available channel settings are limited by local regulations, which determine the number of channels that are available.
 - When multiple BSAP-1600s are deployed in the same area, be sure to choose a channel separated by at least two channels for 802.11a to avoid having the channels interfere with each other, and at least five channels for 802.11b/g. You can deploy up to four BSAP-1600s in the same area for 802.11a (e.g., channels 36, 56, 149, 165) and three BSAP-1600s for 802.11b/g (e.g., channels 1, 6, 11).
 - For most wireless adapters, the channel for wireless clients is automatically set to the same as that used by the BSAP-1600 to which it is linked.

Example

```
Enterprise AP(if-wireless g)#channel 1
Enterprise AP(if-wireless g)#
```

transmit-power

This command adjusts the power of the radio signals transmitted from the BSAP-1600.

Syntax `transmit-power <signal-strength>`

signal-strength - Signal strength transmitted from the BSAP-1600. (Options: full, half, quarter, eighth, min)

Default Setting full

Command Mode Interface Configuration (Wireless)

- Command Usage**
- The "min" keyword indicates minimum power.
 - The longer the transmission distance, the higher the transmission power required. But to support the maximum number of users in an area, you must keep the power as low as possible. Power selection is not just a trade off between coverage area and maximum supported clients. You also have to ensure that high strength signals do not interfere with the operation of other radio devices in your area.

Example

```
Enterprise AP(if-wireless g)#transmit-power half
Enterprise AP(if-wireless g)#
```

radio-mode

This command forces the operating mode for the 802.11g wireless interface.

Syntax radio-mode <b | g | b+g>

- **b** - b-only mode: Both 802.11b and 802.11g clients can communicate with the BSAP-1600, but 802.11g clients can only transfer data at 802.11b standard rates (up to 11 Mbps).
- **g** - g-only mode: Only 802.11g clients can communicate with the BSAP-1600 (up to 54 Mbps).
- **b+g** - b & g mixed mode: Both 802.11b and 802.11g clients can communicate with the BSAP-1600 (up to 54 Mbps).

Default Setting b+g mode

Command Mode Interface Configuration (Wireless - 802.11g)

- Command Usage**
- For Japan, only 13 channels are available when set to **g** or **b+g** modes. When set to **b** mode, 14 channels are available.
 - Both the 802.11g and 802.11b standards operate within the 2.4 GHz band. If you are operating in **g** mode, any 802.11b devices in the service area will contribute to the radio frequency noise and affect network performance.

Example

```
Enterprise AP(if-wireless g)#radio-mode g
Enterprise AP(if-wireless g)#
```

preamble

This command sets the length of the signal preamble that is used at the start of a 802.11b/g data transmission.

Syntax preamble [long | short-or-long]

- **long** - Sets the preamble to long (192 microseconds).
- **short-or-long** - Sets the preamble to short if no 802.11b clients are detected (96 microseconds).

Default Setting Short-or-Long

Command Mode Interface Configuration (Wireless - 802.11b/g)

- Command Usage**
- Using a short preamble instead of a long preamble can increase data throughput on the BSAP-1600, but requires that all clients can support a short preamble.
 - Set the preamble to long to ensure the BSAP-1600 can support all 802.11b and 802.11g clients.

Example

```
Enterprise AP(if-wireless g)#preamble short
Enterprise AP(if-wireless g)#
```

antenna control

This command selects the use of two diversity antennas or a single antenna for the radio interface.

Syntax `antenna control <diversity | left | right>`

- **diversity** - The 802.11a and 802.11b/g radios support an antenna diversity system. This helps to provide better RF coverage, and alleviate the impact of multipath. Select this method when using external diversity antennas.
- **left** - The radio only uses the antenna on the left side (the side farthest from the BSAP-1600 LEDs). The BSAP-1600 does not support an external antenna connection on its left antenna. Therefore, this method is not valid for the BSAP-1600.
- **right** - The radio only uses the antenna on the right side (the side closest to the BSAP-1600 LEDs). Select this method when using an optional external antenna that is connected to the right antenna connector.

Default Setting Diversity

Command Mode Interface Configuration (Wireless)

Command Usage The antenna ID must be selected in conjunction with the antenna control method to configure proper use of any of the antenna options.

Example

```
Enterprise AP(if-wireless g)#antenna control right
Enterprise AP(if-wireless g)#
```

antenna id

This command specifies the antenna type connected to the BSAP-1600 represented by a four-digit hexadecimal ID number, either the integrated diversity antennas (the "Default Antenna") or an optional external antenna.

Syntax `antenna id <antenna-id>`

- *antenna-id* - Specifies the ID number of an approved antenna that is connected to the BSAP-1600
(Range: 0x0000 - 0xFFFF)

Default Setting 0x0000 (built-in antennas)

Command Mode Interface Configuration (Wireless)

Command Usage

- The optional external antennas (if any) that are certified for use with the BSAP-1600 are listed by typing **antenna control id ?**. Selecting the correct antenna ID ensures that the BSAP-1600's radio transmissions are within regulatory power limits for the country of operation.
- The antenna ID must be selected in conjunction with the antenna control method to configure proper use of any of the antenna options.

Example

```
Enterprise AP(if-wireless g)#antenna id 0000
Enterprise AP(if-wireless g)#
```

antenna location

This command selects the antenna mounting location for the radio interface.

Syntax antenna location <indoor | outdoor>

- **indoor** - The antenna is mounted indoors.
- **outdoor** - The antenna is mounted outdoors.

Default Setting Indoor

Command Mode Interface Configuration (Wireless)

Command Usage

- When an external antenna is selected, the antenna control must be set to "right."
- Selecting the correct location ensures that the BSAP-1600 only uses radio channels that are permitted in the country of operation.

Example

```
Enterprise AP(if-wireless g)#antenna location indoor
Enterprise AP(if-wireless g)#
```

beacon-interval

This command configures the rate at which beacon signals are transmitted from the BSAP-1600.

Syntax beacon-interval <interval>
interval - The rate for transmitting beacon signals. (Range: 201000 milliseconds)

Default Setting 100

Command Mode Interface Configuration (Wireless)

Command Usage The beacon signals allow wireless clients to maintain contact with the BSAP-1600. They may also carry power-management information.

Example

```
Enterprise AP(if-wireless g)#beacon-interval 150
Enterprise AP(if-wireless g)#
```

dtim-period

This command configures the rate at which stations in sleep mode must wake up to receive broadcast/multicast transmissions.

Syntax `dtim-period <interval>`

interval - Interval between the beacon frames that transmit broadcast or multicast traffic. (Range: 1255 beacon frames)

Default Setting 1

Command Mode Interface Configuration (Wireless)

Command Usage

- The Delivery Traffic Indication Map (DTIM) packet interval value indicates how often the MAC layer forwards broadcast/multicast traffic. This parameter is necessary to wake up stations that are using Power Save mode.
- The DTIM is the interval between two synchronous frames with broadcast/multicast information. The default value of 2 indicates that the BSAP-1600 will save all broadcast/multicast frames for the Basic Service Set (BSS) and forward them after every second beacon.
- Using smaller DTIM intervals delivers broadcast/multicast frames in a more timely manner, causing stations in Power Save mode to wake up more often and drain power faster. Using higher DTIM values reduces the power used by stations in Power Save mode, but delays the transmission of broadcast/multicast frames.

Example

```
Enterprise AP(if-wireless g)#dtim-period 100
Enterprise AP(if-wireless g)#
```

fragmentation-length

This command configures the minimum packet size that can be fragmented when passing through the BSAP-1600.

Syntax `fragmentation-length <length>`

length - Minimum packet size for which fragmentation is allowed. (Range: 256-2346 bytes)

Default Setting 2346

Command Mode Interface Configuration (Wireless)

Command Usage

- If the packet size is smaller than the preset Fragment size, the packet will not be segmented.
- Fragmentation of the PDUs (Package Data Unit) can increase the reliability of transmissions because it increases the probability of a successful transmission due to smaller frame size. If there is significant interference present, or collisions due to high network utilization, try setting the fragment size to send smaller fragments. This will speed up the retransmission of smaller frames. However, it is more efficient to set the fragment size larger if very little or no interference is present because it requires overhead to send multiple frames.

Example

```
Enterprise AP(if-wireless g)#fragmentation-length 512
Enterprise AP(if-wireless g)#
```

rts-threshold

This command sets the packet size threshold at which a Request to Send (RTS) signal must be sent to the receiving station prior to the sending station starting communications.

Syntax `rts-threshold <threshold>`

threshold - Threshold packet size for which to send an RTS. (Range: 0-2347 bytes)

Default Setting 2347

Command Mode Interface Configuration (Wireless)

- Command Usage**
- If the threshold is set to 0, the BSAP-1600 always sends RTS signals. If set to 2347, the BSAP-1600 never sends RTS signals. If set to any other value, and the packet size equals or exceeds the RTS threshold, the RTS/CTS (Request to Send / Clear to Send) mechanism will be enabled.
 - The BSAP-1600 sends RTS frames to a receiving station to negotiate the sending of a data frame. After receiving an RTS frame, the station sends a CTS frame to notify the sending station that it can start sending data.
 - BSAP-1600s contending for the wireless medium may not be aware of each other. The RTS/CTS mechanism can solve this "Hidden Node" problem.

Example

```
Enterprise AP(if-wireless g)#rts-threshold 256
Enterprise AP(if-wireless g)#
```

super-a

This command enables Atheros proprietary Super A performance enhancements. Use the **no** form to disable this function.

Syntax `[no] super-a`

Default Setting Disabled

Command Mode Interface Configuration (Wireless - 802.11a)

Command Usage Super A enhancements include bursting, compression, and fast frames. Maximum throughput ranges between 40 to 60 Mbps for connections to Atheros-compatible clients.

Example

```
Enterprise AP(if-wireless a)#super a
Enterprise AP(if-wireless a)#
```

super-g

This command enables Atheros proprietary Super G performance enhancements. Use the **no** form to disable this function.

Syntax [no] super-g

Default Setting Disabled

Command Mode Interface Configuration (Wireless - 802.11g)

Command Usage These enhancements include bursting, compression, fast frames and dynamic turbo. Maximum throughput ranges between 40 to 60 Mbps for connections to Atheros-compatible clients.

Example

```
Enterprise AP(if-wireless a)#super g
Enterprise AP(if-wireless a)#
```

description

This command adds a description to a the wireless interface. Use the **no** form to remove the description.

Syntax description <string>
no description

string - Comment or a description for this interface.
(Range: 1-80 characters)

Default Setting

Radio A: Enterprise 802.11a Access Point

Radio G: Enterprise 802.11g Access Point

Command Mode Interface Configuration (Wireless-VAP)

Example

```
Enterprise AP(if-wireless g: VAP[0])#description RD-AP#3
Enterprise AP(if-wireless g: VAP[0])#
```

ssid

This command configures the service set identifier (SSID).

Syntax ssid <string>

string - The name of a basic service set supported by the BSAP-1600. (Range: 0 - 7 characters)

Default Setting 802.11a Radio: VAP_TEST_11A (0 to 3)
802.11g Radio: VAP_TEST_11G (0 to 3)

Command Mode Interface Configuration (Wireless-VAP)

Command Usage Clients that want to connect to the wireless network via an access point must set their SSIDs to the same as that of the BSAP-1600.

Example

```
Enterprise AP(if-wireless g: VAP[0])#ssid RD-AP#3
Enterprise AP(if-wireless g)#
```

closed-system

This command prohibits access to clients without a pre-configured SSID. Use the **no** form to disable this feature.

Syntax closed-system
no closed-system

Default Setting Disabled

Command Mode Interface Configuration (Wireless-VAP)

Command Usage When closed system is enabled, the BSAP-1600 will not include its SSID in beacon messages. Nor will it respond to probe requests from clients that do not include a fixed SSID.

Example

```
Enterprise AP(if-wireless g: VAP[0])#closed-system
Enterprise AP(if-wireless g)#
```

max-association

This command configures the maximum number of clients that can be associated with the BSAP-1600 at the same time.

Syntax max-association <count>
count - Maximum number of associated stations. (Range: 0-64)

Default Setting 64

Command Mode Interface Configuration (Wireless-VAP)

Example

```
Enterprise AP(if-wireless g: VAP[0])#max-association 32
Enterprise AP(if-wireless g)#
```

assoc-timeout-interval

This command configures the idle time interval (when no frames are sent) after which the client is disassociated from the VAP interface.

Syntax assoc-timeout-interval <minutes>
minutes - The number of minutes of inactivity before disassociation. (Range: 5-60)

Default Setting 30

Command Mode Interface Configuration (Wireless-VAP)

Example

```
Enterprise AP(if-wireless g: VAP[0])#association-timeout-interval 20
Enterprise AP(if-wireless g: VAP[0])#
```

auth-timeout-value

This command configures the time interval within which clients must complete authentication to the VAP interface.

Syntax **auth-timeout-value** <minutes>

minutes - The number of minutes before re-authentication. (Range: 5-60)

Default Setting 60

Command Mode Interface Configuration (Wireless-VAP)

Example

```
Enterprise AP(if-wireless g: VAP[0])#auth-timeout-value 40
Enterprise AP(if-wireless g: VAP[0])#
```

shutdown

This command disables the wireless interface. Use the **no** form to restart the interface.

Syntax shutdown
no shutdown

Default Setting Interface enabled

Command Mode Interface Configuration (Wireless-VAP)

Command Usage You must first enable VAP interface 0 before you can enable VAP interfaces 1, 2, 3, 4, 5, 6, or 7.

Example

```
Enterprise AP(if-wireless g: VAP[0])#shutdown
Enterprise AP(if-wireless g)#
```

show interface wireless

This command displays the status for the wireless interface.

Syntax **show interface wireless** <a | g> *vap-id*

- **a** - 802.11a radio interface.
- **g** - 802.11g radio interface.
- *vap-id* - The number that identifies the VAP interface. (Options: 0~3)

Command Mode Exec

Example

```

Enterprise AP#show interface wireless g 0

Wireless Interface Information
=====
-----Identification-----
Description                : Enterprise 802.11g Access Point
SSID                       : VAP_TEST_11G 0
Channel                     : 1 (AUTO)
Status                     : ENABLED
MAC Address                 : 00:03:7f:fe:03:02
-----802.11 Parameters-----
Radio Mode                  : b & g mixed mode
Protection Method           : CTS only
Transmit Power              : FULL (16 dBm)
Max Station Data Rate       : 54Mbps
Multicast Data Rate         : 5.5Mbps
Fragmentation Threshold     : 2346 bytes
RTS Threshold               : 2347 bytes
Beacon Interval             : 100 TUs
Authentication Timeout Interval : 60 Mins
Association Timeout Interval : 30 Mins
DTIM Interval               : 1 beacon
Preamble Length             : LONG
Maximum Association         : 64 stations
MIC Mode                    : Software
Super G                     : Disabled
VLAN ID                     : 1
-----Security-----
Closed System               : Disabled
Multicast cipher            : WEP
Unicast cipher              : TKIP and AES
WPA clients                 : DISABLED
WPA Key Mgmt Mode           : PRE SHARED KEY
WPA PSK Key Type            : PASSPHRASE
WPA PSK Key                 : EMPTY
PMKSA Lifetime              : 720 minutes
Encryption                  : ENABLED
Default Transmit Key        : 1
Common Static Keys          : Key 1: EMPTY      Key 2: EMPTY
                           : Key 3: EMPTY      Key 4: EMPTY
Pre-Authentication         : DISABLED
Authentication Type         : SHARED

```

```

-----802.1x-----
802.1x                               : DISABLED
Broadcast Key Refresh Rate           : 30 min
Session Key Refresh Rate              : 30 min
802.1x Session Timeout Value         : 0 min
-----Antenna-----
Antenna Control method                : Diversity
Antenna ID                           : 0x0000(Default Antenna)
Antenna Location                      : Indoor
-----Quality of Service-----
WMM Mode                              : SUPPORTED
WMM Acknowledge Policy
AC0(Best Effort)                     : Acknowledge
AC1(Background)                      : Acknowledge
AC2(Video)                           : Acknowledge
AC3(Voice)                            : Acknowledge
WMM BSS Parameters
AC0(Best Effort)                     : logCwMin: 4 logCwMax: 10 AIFSN: 3
Admission Control: No
TXOP Limit: 0.000 ms
AC1(Background)                      : logCwMin: 4 logCwMax: 10 AIFSN: 7
Admission Control: No
TXOP Limit: 0.000 ms
AC2(Video)                           : logCwMin: 3 logCwMax: 4 AIFSN: 2
Admission Control: No
TXOP Limit: 3.008 ms
AC3(Voice)                            : logCwMin: 2 logCwMax: 3 AIFSN: 2
Admission Control: No
TXOP Limit: 1.504 ms
WMM AP Parameters
AC0(Best Effort)                     : logCwMin: 4 logCwMax: 6 AIFSN: 3
Admission Control: No
TXOP Limit: 0.000 ms
AC1(Background)                      : logCwMin: 4 logCwMax: 10 AIFSN: 7
Admission Control: No
TXOP Limit: 0.000 ms
AC2(Video)                           : logCwMin: 3 logCwMax: 4 AIFSN: 1
Admission Control: No
TXOP Limit: 3.008 ms
AC3(Voice)                            : logCwMin: 2 logCwMax: 3 AIFSN: 1
Admission Control: No
TXOP Limit: 1.504 ms
=====
Enterprise AP#

```

show station

This command shows the wireless clients associated with the BSAP-1600.

Command Mode Exec

Example

```
Enterprise AP#show station

Station Table Information
=====
if-wireless A VAP [0] :
802.11a Channel : 60

No 802.11a Channel Stations.
.
if-wireless G VAP [0] :
802.11g Channel : 1
802.11g Channel Station Table

Station Address : 00-04-23-94-9A-9C VLAN ID: 0
Authenticated Associated Forwarding KeyType
TRUE FALSE FALSE NONE
Counters:pkts Tx / Rx bytes Tx / Rx
                20/ 0 721/ 0
Time:Associated LastAssoc LastDisAssoc LastAuth
                0 0 0 0
if-wireless G VAP [1] :
802.11g Channel : 1

No 802.11g Channel Stations.
.
Enterprise AP#
```

Rogue AP Detection Commands

A “rogue AP” is either an access point that is not authorized to participate in the wireless network, or an access point that does not have the correct security configuration. Rogue APs can potentially allow unauthorized users access to the network. Alternatively, client stations may mistakenly associate to a rogue AP and be prevented from accessing network resources. Rogue APs may also cause radio interference and degrade the wireless LAN performance.

The BSAP-1600 can be configured to periodically scan all radio channels and find other access points within range. A database of nearby access points is maintained where any rogue APs can be identified.

Table 7-21: Rogue AP Detection Commands

Command	Function	Mode	Page
rogue-ap enable	Enables the periodic detection of other nearby access points	GC	7-95
rogue-ap authenticate	Enables identification of all access points	GC	7-96
rogue-ap duration	Sets the duration that all channels are scanned	GC	7-96
rogue-ap interval	Sets the time between each scan	GC	7-97
rogue-ap scan	Forces an immediate scan of all radio channels	GC	7-97
show rogue-ap	Shows the current database of detected access points	Exec	7-98

rogue-ap enable

This command enables the periodic detection of nearby access points. Use the **no** form to disable periodic detection.

Syntax [no] rogue-ap enable

Default Setting Disabled

Command Mode Interface Configuration (Wireless)

- Command Usage**
- While the BSAP-1600 scans a channel for rogue APs, wireless clients will not be able to connect to the BSAP-1600. Therefore, avoid frequent scanning or scans of a long duration unless there is a reason to believe that more intensive scanning is required to find a rogue AP.
 - A “rogue AP” is either an access point that is not authorized to participate in the wireless network, or an access point that does not have the correct security configuration. Rogue access points can be identified by unknown BSSID (MAC address) or SSID configuration. A database of nearby access points should therefore be maintained on a RADIUS server, allowing any rogue APs to be identified (see “rogue-ap authenticate” on page 7-96). The rogue AP database can be viewed using the **show rogue-ap** command.

- The BSAP-1600 sends Syslog messages for each detected access point during a rogue AP scan.

Example

```
Enterprise AP(if-wireless g)#rogue-ap enable
configure either syslog or trap or both to receive the rogue APs detected.
Enterprise AP(if-wireless g)#
```

rogue-ap authenticate

This command forces the BSAP-1600 to authenticate all access points on the network. Use the **no** form to disable this function.

Syntax [no] **rogue-ap authenticate**

Default Setting Disabled

Command Mode Interface Configuration (Wireless)

Command Usage Enabling authentication in conjunction with a database of approved BSAP-1600s stored on a RADIUS server allows the BSAP-1600 to discover rogue APs. With authentication enabled and a configured RADIUS server, the BSAP-1600 checks the MAC address/ Basic Service Set Identifier (BSSID) of each access point that it finds against a RADIUS server to determine whether the access point is allowed. With authentication disabled, the BSAP-1600 can identify its neighboring access points only; it cannot identify whether the access points are allowed or are rogues. If you enable authentication, you should also configure a RADIUS server for this BSAP-1600 (see "RADIUS" on page 5-7).

Example

```
Enterprise AP(if-wireless g)#rogue-ap authenticate
Enterprise AP(if-wireless g)#
```

rogue-ap duration

This command sets the scan duration for detecting access points.

Syntax **rogue-ap duration** <milliseconds>
milliseconds - The duration of the scan. (Range: 100-1000 milliseconds)

Default Setting 350 milliseconds

Command Mode Interface Configuration (Wireless)

Command Usage

- During a scan, client access may be disrupted and new clients may not be able to associate to the BSAP-1600. If clients experience severe disruption, reduce the scan duration time.
- A long scan duration time will detect more access points in the area, but causes more disruption to client access.

Example

```
Enterprise AP(if-wireless g)#rogue-ap duration 200
Enterprise AP(if-wireless g)#
```

Related Commands rogue-ap interval

rogue-ap interval

This command sets the interval at which to scan for access points.

Syntax `rogue-ap interval <minutes>`
minutes - The interval between consecutive scans. (Range: 30-10080 minutes)

Default Setting 720 minutes

Command Mode Interface Configuration (Wireless)

Command Usage This command sets the interval at which scans occur. Frequent scanning will more readily detect other access points, but will cause more disruption to client access.

Example

```
Enterprise AP(if-wireless g)#rogue-ap interval 120
Enterprise AP(if-wireless g)#
```

Related Commands rogue-ap duration

rogue-ap scan

This command starts an immediate scan for access points on the radio interface.

Default Setting Disabled

Command Mode Interface Configuration (Wireless)

Command Usage While the BSAP-1600 scans a channel for rogue APs, wireless clients will not be able to connect to the BSAP-1600. Therefore, avoid frequent scanning or scans of a long duration unless there is a reason to believe that more intensive scanning is required to find a rogue AP.

Example

```
Enterprise AP(if-wireless g)#rogue-ap scan
Enterprise AP(if-wireless g)#rogueApDetect Completed (Radio G) : 9 APs detected
rogueAPDetect (Radio G): refreshing ap database now

Enterprise AP(if-wireless g)#
```

show rogue-ap

This command displays the current rogue AP database.

Command Mode Exec

Example

```
Enterprise AP#show rogue-ap

802.11a Channel : Rogue AP Status
AP Address (BSSID)          SSID    Channel (MHz)  RSSI  Type  Privacy  RSN
=====
802.11g Channel : Rogue AP Status
AP Address (BSSID)          SSID    Channel (MHz)  RSSI  Type  Privacy  RSN
=====
00-04-e2-2a-37-23          WLAN1AP  11 (2462 MHz)  17   ESS   0        0
00-04-e2-2a-37-3d          ANY      7 (2442 MHz)  42   ESS   0        0
00-04-e2-2a-37-49          WLAN1AP  9 (2452 MHz)  42   ESS   0        0
00-90-d1-08-9d-a7          WLAN1AP  1 (2412 MHz)  12   ESS   0        0
00-30-f1-fb-31-f4          WLAN    6 (2437 MHz)  16   ESS   0        0
Enterprise AP#
```

Wireless Security Commands

Commands to configure security parameters on the 802.11a and 802.11g interfaces.

Table 7-22: Wireless Security Commands

Command	Function	Mode	Page
auth	Defines the 802.11 authentication type allowed by the BSAP-1600	IC-W-VAP	7-99
encryption	Defines whether or not WEP encryption is used to provide privacy for wireless communications	IC-W-VAP	7-100
key	Sets the keys used for WEP encryption	IC-W	7-101
transmit-key	Sets the index of the key to be used for encrypting data frames sent between the BSAP-1600 and wireless clients	IC-W-VAP	7-102
cipher-suite	Selects an encryption method for the global key used for multicast and broadcast traffic	IC-W-VAP	7-102
mic_mode	Specifies how to calculate the Message Integrity Check (MIC)	IC-W	7-103
wpa-pre-shared-key	Defines a WPA preshared-key value	IC-W-VAP	7-104
pmksa-lifetime	Sets the lifetime PMK security associations	IC-W-VAP	7-104
pre-authentication	Enables WPA2 pre-authentication for fast roaming	IC-W-VAP	7-105

auth

This command configures authentication for the VAP interface.

- Syntax** `auth <open-system | shared-key | wpa | wpa-psk | wpa2 | wpa2-psk | wpa-wpa2-mixed | wpa-wpa2-psk-mixed | > <required | supported>`
- **open-system** - Accepts the client without verifying its identity using a shared key. "Open" authentication means either there is no encryption (if encryption is disabled) or WEP-only encryption is used (if encryption is enabled).
 - **shared-key** - Authentication is based on a shared key that has been distributed to all stations.
 - **wpa** - Clients using WPA are accepted for authentication.
 - **wpa-psk** - Clients using WPA with a Pre-shared Key are accepted for authentication.
 - **wpa2** - Clients using WPA2 are accepted for authentication.
 - **wpa2-psk** - Clients using WPA2 with a Pre-shared Key are accepted for authentication.
 - **wpa-wpa2-mixed** - Clients using WPA or WPA2 are accepted for authentication.
 - **wpa-wpa2-psk-mixed** - Clients using WPA or WPA2 with a Pre-shared Key are accepted for authentication.
 - **required** - Clients are required to use WPA or WPA2.
 - **supported** - Clients may use WPA or WPA2, if supported.

Default Setting open-system

Command Mode Interface Configuration (Wireless-VAP)

- Command Usage**
- The **auth** command automatically configures settings for each authentication type, including encryption, 802.1X, and cipher suite. The command **auth open-system** disables encryption and 802.1X.
 - To use WEP shared-key authentication, set the authentication type to "shared-key" and define at least one static WEP key with the **key** command. Encryption is automatically enabled by the command.
 - To use WEP encryption only (no authentication), set the authentication type to "open-system." Then enable WEP with the **encryption** command, and define at least one static WEP key with the **key** command.
 - When any WPA or WPA2 option is selected, clients are authenticated using 802.1X via a RADIUS server. Each client must be WPA-enabled or support 802.1X client software. The 802.1X settings (See "802.1X Authentication" on page 7-55.) and RADIUS server details (See "RADIUS Client" on page 7-50.) must be configured on the BSAP-1600. A RADIUS server must also be configured and be available in the wired network.
 - If a WPA/WPA2 mode that operates over 802.1X is selected (WPA, WPA2, WPA-WPA2-mixed, or WPA-WPA2-PSK-mixed), the 802.1X settings (See "802.1X Authentication" on page 7-55.) and RADIUS server details (See "RADIUS Client" on page 7-50.) must be configured. Be sure you have also configured a RADIUS server on the network before enabling authentication. Also,

note that each client has to be WPA-enabled or support 802.1X client software. A RADIUS server must also be configured and be available in the wired network.

- If a WPA/WPA2 Pre-shared Key mode is selected (WPA-PSK, WPA2-PSK or WPA-WPA2-PSK-mixed), the key must first be generated and distributed to all wireless clients before they can successfully associate with the BSAP-1600. Use the `wpa-preshared-key` command to configure the key (see `key` and `transmit-key`).
- WPA2 defines a transitional mode of operation for networks moving from WPA security to WPA2. WPA2 Mixed Mode allows both WPA and WPA2 clients to associate to a common VAP interface. When the encryption cipher suite is set to TKIP, the unicast encryption cipher (TKIP or AES-CCMP) is negotiated for each client. The BSAP-1600 advertises its supported encryption ciphers in beacon frames and probe responses. WPA and WPA2 clients select the cipher they support and return the choice in the association request to the BSAP-1600. For mixed-mode operation, the cipher used for broadcast frames is always TKIP. WEP encryption is not allowed.
- The “required” option places the VAP into TKIP only mode. The “supported” option places the VAP into TKIP+AES+WEP mode. The “required” mode is used in WPA-only environments.
- The “supported” mode can be used for mixed environments with legacy WPA products, specifically WEP. (For example, WPA+WEP. The WPA2+WEP environment is not available because WPA2 does not support WEP). To place the VAP into AES only mode, use “required” and then select the “cipher-ccmp” option for the cipher-suite command.

Example

```
Enterprise AP(if-wireless g: VAP[0])#auth shared-key
Enterprise AP(if-wireless g)#
```

Related Commands encryption

encryption

This command enables data encryption for wireless communications. Use the **no** form to disable data encryption.

Syntax encryption
no encryption

Default Setting disabled

Command Mode Interface Configuration (Wireless-VAP)

- Command Usage**
- Wired Equivalent Privacy (WEP) is implemented in this device to prevent unauthorized access to your wireless network. For more secure data transmissions, enable encryption with this command, and set at least one static WEP key with the **key** command.
 - The WEP settings must be the same on each client in your wireless network.

- Note that WEP protects data transmitted between wireless nodes, but does not protect any transmissions over your wired network or over the Internet.
- You must enable data encryption in order to enable all types of encryption (WEP, TKIP, and AES-CCMP) in the BSAP-1600.

Example

```
Enterprise AP(if-wireless g: VAP[0])#encryption
Enterprise AP(if-wireless g)#
```

**Related
Commands****key**

This command sets the keys used for WEP encryption. Use the **no** form to delete a configured key.

Syntax **key** <index> <size> <type> <value>
no key index

- *index* - Key index. (Range: 1-4)
 - *size* - Key size. (Options: 64, 128, or 152 bits)
 - *type* - Input format. (Options: ASCII, HEX)
 - *value* - The key string.
- For 64-bit keys, use 5 alphanumeric characters or 10 hexadecimal digits.
 - For 128-bit keys, use 13 alphanumeric characters or 26 hexadecimal digits.
 - For 152-bit keys, use 16 alphanumeric characters or 32 hexadecimal digits.

Default Setting None

Command Mode Interface Configuration (Wireless)

- Command Usage**
- To enable Wired Equivalent Privacy (WEP), use the **auth shared-key** command to select the "shared key" authentication type, use the **key** command to configure at least one key, and use the **transmit-key** command to assign a key to one of the VAP interfaces.
 - If WEP option is enabled, all wireless clients must be configured with the same shared keys to communicate with the BSAP-1600.
 - The encryption index, length and type configured in the BSAP-1600 must match those configured in the clients.

Example

```
Enterprise AP(if-wireless g)#key 1 64 hex 1234512345
Enterprise AP(if-wireless g)#key 2 128 ascii asdeipadjsipd
Enterprise AP(if-wireless g)#key 3 64 hex
1234512345123451234512345123456
Enterprise AP(if-wireless g)#
```

Related Commands key transmit-key

transmit-key

This command sets the index of the key to be used for encrypting data frames for broadcast or multicast traffic transmitted from the VAP to wireless clients.

Syntax `transmit-key <index>`
index - Key index. (Range: 1-4)

Default Setting 1

Command Mode Interface Configuration (Wireless-VAP)

Command Usage

- If you use WEP key encryption option, the BSAP-1600 uses the transmit key to encrypt multicast and broadcast data signals that it sends to client devices. Other keys can be used for decryption of data from clients.
- When using IEEE 802.1X, the BSAP-1600 uses a dynamic key to encrypt unicast and broadcast messages to 802.1X-enabled clients. However, because the BSAP-1600 sends the keys during the 802.1X authentication process, these keys do not have to appear in the client's key list.
- In a mixed-mode environment with clients using static and dynamic keys, select transmit key index 2, 3, or 4. The BSAP-1600 uses transmit key index 1 for the generation of dynamic keys.

Example

```
Enterprise AP(if-wireless g: VAP[0])#transmit-key 2
Enterprise AP(if-wireless g)#
```

cipher-suite

This command defines the cipher algorithm used to encrypt the global key for broadcast and multicast traffic when using Wi-Fi Protected Access (WPA) security.

Syntax `multicast-cipher <aes-ccmp | tkip | wep>`

- **aes-ccmp** - Use AES-CCMP encryption for the unicast and multicast cipher.
- **tkip** - Use TKIP encryption for the multicast cipher. TKIP or AES-CCMP can be used for the unicast cipher depending on the capability of the client.
- **wep** - Use WEP encryption for the multicast cipher. TKIP or AES-CCMP can be used for the unicast cipher depending on the capability of the client.

Default Setting wep

Command Mode Interface Configuration (Wireless-VAP)

Command Usage

- WPA enables the BSAP-1600 to support different unicast encryption keys for each client. However, the global encryption key for multicast and broadcast traffic must be the same for all clients.

- If any clients supported by the BSAP-1600 are not WPA enabled, the multicast-cipher algorithm must be set to WEP.
- WEP is the first generation security protocol used to encrypt data crossing the wireless medium using a fairly short key. Communicating devices must use the same WEP key to encrypt and decrypt radio signals. WEP has many security flaws, and is not recommended for transmitting highly sensitive data.
- TKIP provides data encryption enhancements including per-packet key hashing (i.e., changing the encryption key on each packet), a message integrity check, an extended initialization vector with sequencing rules, and a re-keying mechanism. Select TKIP if there are clients in the network that are not WPA2 compliant.
- TKIP defends against attacks on WEP in which the unencrypted initialization vector in encrypted packets is used to calculate the WEP key. TKIP changes the encryption key on each packet, and rotates not just the unicast keys, but the broadcast keys as well. TKIP is a replacement for WEP that removes the predictability that intruders relied on to determine the WEP key.
- AES-CCMP (Advanced Encryption Standard Counter-Mode/CBCMAC Protocol): WPA2 is backward compatible with WPA, including the same 802.1X and PSK modes of operation and support for TKIP encryption. The main enhancement is its use of AES Counter-Mode encryption with Cipher Block Chaining Message Authentication Code (CBC-MAC) for message integrity. The AES Counter-Mode/CBCMAC Protocol (AES-CCMP) provides extremely robust data confidentiality using a 128-bit key. The AES-CCMP encryption cipher is specified as a standard requirement for WPA2. However, the computational intensive operations of AES-CCMP requires hardware support on client devices. Therefore to implement WPA2 in the network, wireless clients must be upgraded to WPA2-compliant hardware.

Example

```
Enterprise AP(if-wireless g: VAP[0])#multicast-cipher TKIP
Enterprise AP(if-wireless g)#
```

mic_mode

This command specifies how to calculate the Message Integrity Check (MIC).

Syntax `mic_mode <hardware | software>`

- **hardware** - Uses hardware to calculate the MIC.
- **software** - Uses software to calculate the MIC.

Default Setting software

Command Mode Interface Configuration (Wireless)

Command Usage

- The Michael Integrity Check (MIC) is part of the Temporal Key Integrity Protocol (TKIP) encryption used in Wi-Fi Protected Access (WPA) security. The MIC calculation is performed in the BSAP-1600 for each transmitted packet and this can impact throughput and performance. The BSAP-1600 supports a choice of hardware or software for MIC calculation. The performance of the BSAP-1600 can be improved by selecting the best method for the specific deployment.

- Using the “hardware” option provides best performance when the number of supported clients is less than 27.
- Using the “software” option provides the best performance for a large number of clients on one radio interface. Throughput may be reduced when both 802.11a and 802.11g interfaces are supporting a high number of clients simultaneously.

Example

```
Enterprise AP(if-wireless a)#mic_mode hardware
Enterprise AP(if-wireless g)#
```

wpa-pre-shared-key

This command defines a Wi-Fi Protected Access (WPA/WPA2) Pre-shared-key.

Syntax wpa-pre-shared-key <hex / passphrase-key> <value>

- **hex** - Specifies hexadecimal digits as the key input format.
- **passphrase-key** - Specifies an ASCII pass-phrase string as the key input format.
- **value** - The key string. For ASCII input, specify a string between 8 and 63 characters. For HEX input, specify exactly 64 digits.

Command Mode Interface Configuration (Wireless-VAP)

Command Usage

- To support WPA or WPA2 for client authentication, use the **auth** command to specify the authentication type, and use the **wpa-pre-shared-key** command to specify one static key.
- If WPA or WPA2 is used with pre-shared-key mode, all wireless clients must be configured with the same pre-shared key to communicate with the BSAP-1600’s VAP interface.

Example

```
Enterprise AP(if-wireless g: VAP[0])#wpa-pre-shared-key ASCII agoodsecret
Enterprise AP(if-wireless g)#
```

Related Commands auth

pmksa-lifetime

This command sets the time for aging out cached WPA2 Pairwise Master Key Security Association (PMKSA) information for fast roaming.

Syntax pmksa-lifetime <minutes>
minutes - The time for aging out PMKSA information. (Range: 0 - 14400 minutes)

Default Setting 720 minutes

Command Mode Interface Configuration (Wireless-VAP)

Command Usage

- WPA2 provides fast roaming for authenticated clients by retaining keys and other security information in a cache, so that if a client roams away from an BSAP-1600 and then returns reauthentication is not required.
- When a WPA2 client is first authenticated, it receives a Pairwise Master Key (PMK) that is used to generate other keys for unicast data encryption. This key and other client information form a Security Association that the BSAP-1600 names and holds in a cache. The lifetime of this security association can be configured with this command. When the lifetime expires, the client security association and keys are deleted from the cache. If the client returns to the BSAP-1600, it requires full reauthentication.
- The BSAP-1600 can store up to 256 entries in the PMKSA cache.

Example

```
Enterprise AP(if-wireless g: VAP[0])#wpa-pre-shared-key ASCII agoodsecret
Enterprise AP(if-wireless g: VAP[0])#
```

pre-authentication

This command enables WPA2 pre-authentication for fast secure roaming.

Syntax pre-authentication <enable | disable>

- **enable** - Enables pre-authentication for the VAP interface.
- **disable** - Disables pre-authentication for the VAP interface.

Default Setting Disabled

Command Mode Interface Configuration (Wireless-VAP)

Command Usage

- Each time a client roams to another BSAP-1600 it has to be fully re-authenticated. This authentication process is time consuming and can disrupt applications running over the network. WPA2 includes a mechanism, known as pre-authentication, that allows clients to roam to a new BSAP-1600 and be quickly associated. The first time a client is authenticated to a wireless network it has to be fully authenticated. When the client is about to roam to another BSAP-1600 in the network, the BSAP-1600 sends pre-authentication messages to the new BSAP-1600 that include the client's security association information. Then when the client sends an association request to the new BSAP-1600 the client is known to be already authenticated, so it proceeds directly to key exchange and association.
- To support pre-authentication, both clients and BSAP-1600s in the network must be WPA2 enabled.
- Pre-authentication requires all BSAP-1600s in the network to be on the same IP subnet.

Example

```
Enterprise AP(if-wireless g: VAP[0])#wpa-pre-shared-key ASCII agoodsecret
Enterprise AP(if-wireless g: VAP[0])#
```

Link Integrity Commands

The BSAP-1600 provides a link integrity feature that can be used to ensure that wireless clients are connected to resources on the wired network. The BSAP-1600 does this by periodically sending Ping messages to a host device in the wired Ethernet network. If the BSAP-1600 detects that the connection to the host has failed, it disables the radio interfaces, forcing clients to find and associate with another BSAP-1600. When the connection to the host is restored, the BSAP-1600 re-enables the radio interfaces.

Table 7-23: Link Integrity Commands

Command	Function	Mode	Page
link-integrity ping-detect	Enables link integrity detection	GC	7-106
link-integrity ping-host	Specifies the IP address of a host device in the wired network	GC	7-107 7-107
link-integrity ping-interval	Specifies the time between each Ping sent to the link host	GC	7-107
link-integrity ping-fail-retry	Specifies the number of consecutive failed Ping counts before the link is determined as lost	GC	7-107
link-integrity ethernet-detect	Enables integrity check for Ethernet link	GC	7-108
show link-integrity	Displays the current link integrity configuration	Exec	7-108

link-integrity ping-detect

This command enables link integrity detection. Use the **no** form to disable link integrity detection.

Syntax [no] link-integrity ping-detect

Default Setting Disabled

Command Mode Global Configuration

Command Usage

- When link integrity is enabled, the IP address of a host device in the wired network must be specified.
- The BSAP-1600 periodically sends an ICMP echo request (Ping) packet to the link host IP address. When the number of failed responses (either the host does not respond or is unreachable) exceeds the limit set by the **link-integrity ping-fail-retry** command, the link is determined as lost.

Example

```
Enterprise AP(config)#link-integrity ping-detect
Enterprise AP(config)#
```

link-integrity ping-host

This command configures the link host name or IP address. Use the **no** form to remove the host setting.

Syntax link-integrity ping-host <host_name / ip_address>
no link-integrity ping-host

- *host_name* - Alias of the host.
- *ip_address* - IP address of the host.

Default Setting None

Command Mode Global Configuration

Example

```
Enterprise AP(config)#link-integrity ping-host 192.168.1.10
Enterprise AP(config)#
```

link-integrity ping-interval

This command configures the time between each Ping sent to the link host.

Syntax link-integrity ping-interval <interval>
interval - The time between Pings. (Range: 5 - 60 seconds)

Default Setting 30 seconds

Command Mode Global Configuration

Example

```
Enterprise AP(config)#link-integrity ping-interval 20
Enterprise AP(config)#
```

link-integrity ping-fail-retry

This command configures the number of consecutive failed Ping counts before the link is determined as lost.

Syntax link-integrity ping-fail-retry <counts>
counts - The number of failed Ping counts before the link is determined as lost. (Range: 1 - 10)

Default Setting 6

Command Mode Global Configuration

Example

```
Enterprise AP(config)#link-integrity ping-fail-retry 10
Enterprise AP(config)#
```

link-integrity ethernet-detect

This command enables an integrity check to determine whether or not the BSAP-1600 is connected to the wired Ethernet.

Syntax [no] link-integrity ethernet-detect

Default Setting Disabled

Command Mode Global Configuration

Example

```
Enterprise AP(config)#link-integrity ethernet-detect
Notification : Ethernet Link Detect SUCCESS - RADIO(S) ENABLED
Enterprise AP(config)#
```

show link-integrity

This command displays the current link integrity configuration.

Command Mode Exec

Example •

```
Enterprise AP#show link-integrity
Link Integrity Information
=====
Ethernet Detect : Enabled
Ping Detect      : Enabled
Target IP/Name  : 192.168.0.140
Ping Fail Retry : 6
Ping Interval   : 30
=====
Enterprise AP#
```

IAPP Commands

The command described in this section enables the protocol signaling required to ensure the successful handover of wireless clients roaming between different 802.11f-compliant BSAP-1600s. In other words, the 802.11f protocol can ensure successful roaming between BSAP-1600s in a multi-vendor environment.

iapp

This command enables the protocol signaling required to hand over wireless clients roaming between different 802.11f-compliant access points. Use the **no** form to disable 802.11f signaling.

Syntax [no] *iapp*

Default Enabled

Command Mode Global Configuration

Command Usage The current 802.11 standard does not specify the signaling required between access points in order to support clients roaming from one access point to another. In particular, this can create a problem for clients roaming between access points from different vendors. This command is used to enable or disable 802.11f handover signaling between different access points, especially in a multi-vendor environment.

Example

```
Enterprise AP(config)#iapp
Enterprise AP(config)#
```

VLAN Commands

The BSAP-1600 can enable the support of VLAN-tagged traffic passing between wireless clients and the wired network. Up to 64 VLAN IDs can be mapped to specific wireless clients, allowing users to remain within the same VLAN as they move around a campus site.

When VLAN is enabled on the BSAP-1600, a VLAN ID (a number between 1 and 4094) can be assigned to each client after successful authentication using IEEE 802.1X and a central RADIUS server. The user VLAN IDs must be configured on the RADIUS server for each user authorized to access the network. If a user does not have a configured VLAN ID, the BSAP-1600 assigns the user to its own configured native VLAN ID.

Note: When VLANs are enabled, the BSAP-1600's Ethernet port drops all received traffic that does not include a VLAN tag. To maintain network connectivity to the BSAP-1600 and wireless clients, be sure that the BSAP-1600 is connected to a device port on a wired network that supports IEEE 802.1Q VLAN tags.

The VLAN commands supported by the BSAP-1600 are listed below.

Table 7-24: VLAN Commands

Command	Function	Mode	Page
vlan	Enables a single VLAN for all traffic	GC	7-110
management-vlanid	Configures the management VLAN for the BSAP-1600	GC	7-111
vlan-id	Configures the default VLAN for the VAP interface	IC-W-VAP	7-111

vlan

This command enables VLANs for all traffic. Use the **no** form to disable VLANs.

Syntax [no] vlan enable

Default Disabled

Command Mode Global Configuration

Command Description

- When VLANs are enabled, the BSAP-1600 tags frames received from wireless clients with the VLAN ID configured for each client on the RADIUS server. If the VLAN ID has not been configured for a client on the RADIUS server, then the frames are tagged with the BSAP-1600's native VLAN ID.
- Traffic entering the Ethernet port must be tagged with a VLAN ID that matches the BSAP-1600's native VLAN ID, or with a VLAN tag that matches one of the wireless clients currently associated with the BSAP-1600.

Example

```
Enterprise AP(config)#vlan enable
Reboot system now? <y/n>: y
```

Related Commands management-vlanid

management-vlanid

This command configures the management VLAN ID for the BSAP-1600.

Syntax management-vlanid <vlan-id>
 vlan-id - Management VLAN ID. (Range: 1-4094)

Default Setting 1

Command Mode Global Configuration

Command Usage The management VLAN is for managing the BSAP-1600. For example, the BSAP-1600 allows traffic that is tagged with the specified VLAN to manage the BSAP-1600 via remote management, SSH, SNMP, Telnet, etc.

Example

```
Enterprise AP(config)#management-vlanid 3
Enterprise AP(config)#
```

Related Commands vlan

vlan-id

This command configures the default VLAN ID for the VAP interface.

Syntax vlan-id <vlan-id>
 vlan-id - Native VLAN ID. (Range: 1-4094)

Default Setting 1

Command Mode Interface Configuration (Wireless-VAP)

Command Usage

- To implement the default VLAN ID setting for VAP interface, the BSAP-1600 must enable VLAN support using the **vlan** command.
- When VLANs are enabled, the BSAP-1600 tags frames received from wireless clients with the default VLAN ID for the VAP interface. If IEEE 802.1X is being used to authenticate wireless clients, specific VLAN IDs can be configured on the RADIUS server to be assigned to each client. Using IEEE 802.1X and a central RADIUS server, up to 64 VLAN IDs can be mapped to specific wireless clients.
- If the VLAN ID has not been configured for a client on the RADIUS server, then the frames are tagged with the default VLAN ID of the VAP interface.

Example

```
Enterprise AP(if-wireless g: VAP[0])#vlan-id 3
Enterprise AP(if-wireless g: VAP[0])#
```

WMM Commands

The BSAP-1600 implements QoS using the Wi-Fi Multimedia (WMM) standard. Using WMM, the BSAP-1600 is able to prioritize traffic and optimize performance when multiple applications compete for wireless network bandwidth at the same time. WMM employs techniques that are a subset of the developing IEEE 802.11e QoS standard and it enables the BSAP-1600 to inter-operate with both WMM-enabled clients and other devices that may lack any WMM functionality.

The WMM commands supported by the BSAP-1600 are listed below.

Table 7-25: WMM Commands

Command	Function	Mode	Page
wmm	Sets the WMM operational mode on the BSAP-1600	IC-W	7-112
wmm-acknowledge-policy	Allows the acknowledgement wait time to be enabled or disabled for each Access Category (AC)	IC-W	7-113
wmmparam	Configures detailed WMM parameters that apply to the access point (AP) or the wireless clients (BSS)	IC-W	7-113

wmm

This command sets the WMM operational mode on the BSAP-1600. Use the **no** form to disable WMM.

Syntax [no] wmm <supported | required>

- **supported** - WMM will be used for any associated device that supports this feature. Devices that do not support this feature may still associate with the BSAP-1600.
- **required** - WMM must be supported on any device trying to associate with the BSAP-1600. Devices that do not support this feature will not be allowed to associate with the BSAP-1600.

Default supported

Command Mode Interface Configuration (Wireless)

Example

```
Enterprise AP(if-wireless a)#wmm required
Enterprise AP(if-wireless a)#
```

wmm-acknowledge-policy

This command allows the acknowledgement wait time to be enabled or disabled for each Access Category (AC).

Syntax `wmm-acknowledge-policy <ac_number> <ack | noack>`

- *ac_number* - Access categories. (Range: 0-3)
- **ack** - Require the sender to wait for an acknowledgement from the receiver.
- **noack** - Does not require sender to wait for acknowledgement from the receiver.

Default `ack`

Command Mode Interface Configuration (Wireless)

Command Usage

- WMM defines four access categories (ACs) – voice, video, best effort, and background. These categories correspond to traffic priority levels and are mapped to IEEE 802.1D priority tags (see Table 6-4 on page 6-52). The direct mapping of the four ACs to 802.1D priorities is specifically intended to facilitate interpretability with other wired network QoS policies. While the four ACs are specified for specific types of traffic, WMM allows the priority levels to be configured to match any network-wide QoS policy. WMM also specifies a protocol that BSAP-1600s can use to communicate the configured traffic priority levels to QoS-enabled wireless clients.
- Although turning off the requirement for the sender to wait for an acknowledgement can increase data throughput, it can also result in a high number of errors when traffic levels are heavy.

Example

```
Enterprise AP(if-wireless a)#wmm-acknowledge-policy 0 noack
Enterprise AP(if-wireless a)#
```

wmmparam

This command configures detailed WMM parameters that apply to the access point (AP) or the wireless clients (BSS).

Syntax `wmmparam <AP | BSS> <ac_number> <LogCwMin> <LogCwMax> <AIFS> <TxOpLimit> <admission_control>`

- **AP** - Access Point
- **BSS** - Wireless client
- *ac_number* - Access categories (ACs) – voice, video, best effort, and background. These categories correspond to traffic priority levels and are mapped to IEEE 802.1D priority tags (see Table 6-4 on page 6-52). (Range: 0-3)
- *LogCwMin* - Minimum log value of the contention window. This is the initial upper limit of the random backoff wait time before wireless medium access can be attempted. The initial wait time is a random value between zero and the LogCwMin value. Specify the LogCwMin value. Note that the LogCwMin value must be equal or less than the LogCwMax value. (Range: 1-15 microseconds)
- *LogCwMax* - Maximum log value of the contention window. This is the maximum upper limit of the random backoff wait time before wireless medium access can be attempted. The contention window is doubled after each detected collision up

to the LogCwMax value. Note that the CWMax value must be greater or equal to the LogCwMin value. (Range: 1-15 microseconds)

- *AIFS* - Arbitrary InterFrame Space specifies the minimum amount of wait time before the next data transmission attempt. (Range: 1-15 microseconds)
- *TXOPLimit* - Transmission Opportunity Limit specifies the maximum time an AC transmit queue has access to the wireless medium. When an AC queue is granted a transmit opportunity, it can transmit data for a time up to the TxOpLimit. This data bursting greatly improves the efficiency for high data-rate traffic. (Range: 0-65535 microseconds)
- *admission_control* - The admission control mode for the access category. When enabled, clients are blocked from using the access category. (Options: 0 to disable, 1 to enable)

Default

Table 7-26: AP Parameters

WMM Parameters	ACO (Best Effort)	AC1 (Background)	AC2 (Video)	AC3 (Voice)
LogCwMin	4	4	3	2
LogCwMax	10	10	4	3
AIFS	3	7	2	2
TXOP Limit	0	0	94	47
Admission Control	Disabled	Disabled	Disabled	Disabled

Table 7-27: BSS Parameters

WMM Parameters	ACO (Best Effort)	AC1 (Background)	AC2 (Video)	AC3 (Voice)
LogCwMin	4	4	3	2
LogCwMax	6	10	4	3
AIFS	3	7	1	1
TXOP Limit	0	0	94	47
Admission Control	Disabled	Disabled	Disabled	Disabled

Command Mode Interface Configuration (Wireless)

Example

```
Enterprise AP(if-wireless a)#wmmparams ap 0 4 6 3 1 1
Enterprise AP(if-wireless a)#
```

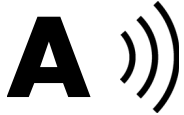
Troubleshooting

Check the following items before you contact local Technical Support.

1. If wireless clients cannot access the network, check the following:

Be sure the BSAP-1600 and the wireless clients are configured with the same Service Set ID (SSID).

If authentication or encryption are enabled, ensure that the wireless clients are properly configured with the appropriate authentication or encryption keys.

If authentication is being performed through a RADIUS server, ensure that the clients are properly configured on the RADIUS server.

If authentication is being performed through IEEE 802.1X, be sure the wireless users have installed and properly configured 802.1X client software.

If MAC address filtering is enabled, be sure the client's address is included in the local filtering database or on the RADIUS server database.

If the wireless clients are roaming between BSAP-1600s, make sure that all the BSAP-1600s and wireless devices in the Extended Service Set (ESS) are configured to the same SSID, and authentication method.

2. If the BSAP-1600 cannot be configured using the Telnet, a web browser, or SNMP software:

Be sure to have configured the BSAP-1600 with a valid IP address, subnet mask and default gateway.

If VLANs are enabled on the BSAP-1600, the management station should be configured to send tagged frames with a VLAN ID that matches the BSAP-1600's management VLAN (see "VLAN" on page 6-16). However, to manage the BSAP-1600 from a wireless client, the AP Management Filter should be disabled ("Filter Control" on page 6-14).

Check that you have a valid network connection to the BSAP-1600 and that the Ethernet port or the wireless interface that you are using has not been disabled.

If you are connecting to the BSAP-1600 through the wired Ethernet interface, check the network cabling between the management sta-

tion and the BSAP-1600. If you are connecting to a BSAP-1600 from a wireless client, ensure that you have a valid connection to the BSAP-1600.

If you cannot connect using Telnet, you may have exceeded the maximum number of concurrent Telnet sessions permitted (i.e, four sessions). Try connecting again at a later time.

3. If you cannot access the on-board configuration program via a serial port connection:

Be sure you have set the terminal emulator program to VT100 compatible, 8 data bits, 1 stop bit, no parity and 9600 bps.

Check that the null-modem serial cable conforms to the pin-out connections provided in "8-Pin DIN Connector Pinout" on page B-3.

4. If you forgot or lost the password:

Set the BSAP-1600 to its default configuration by pressing the reset button on the back panel for 5 seconds or more. Then use the default user name "admin" and a null password to access the management interface.

5. If all other recovery measure fail, and the BSAP-1600 is still not functioning properly, take any of these steps:

Reset the BSAP-1600's hardware using the console interface, web interface, or through a power reset.

Reset the BSAP-1600 to its default configuration by pressing the reset button on the back panel for 5 seconds or more. Then use the default user name "admin" and a null password to access the management interface.

B)))

Cables and Pinouts

Twisted-Pair Cable Assignments

For 10/100BASE-TX connections, a twisted-pair cable must have two pairs of wires. Each wire pair is identified by two different colors. For example, one wire might be green and the other, green with white stripes. Also, an RJ-45 connector must be attached to both ends of the cable.

⚠ Caution: Each wire pair must be attached to the RJ-45 connectors in a specific orientation. (See “Straight-Through Wiring” on page 2 and “Crossover Wiring” on page 2 for an explanation.)

⚠ Caution: DO NOT plug a phone jack connector into the RJ-45 port. Use only twisted-pair cables with RJ-45 connectors that conform with FCC standards.

The following figure illustrates how the pins on the RJ-45 connector are numbered. Be sure to hold the connectors in the same orientation when attaching the wires to the pins.

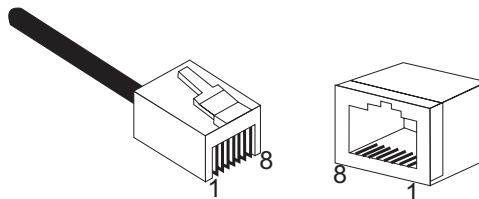

10/100BASE-TX Pin Assignments

Use unshielded twisted-pair (UTP) or shielded twisted-pair (STP) cable for RJ-45 connections: 100-ohm Category 3 or better cable for 10 Mbps connections, or 100-ohm Category 5 or better cable for 100 Mbps connections. Also be sure that the length of any twisted-pair connection does not exceed 100 meters (328 feet).

The RJ-45 port on the BSAP-1600 is wired with MDI pinouts. This means that you must use crossover cables for connections to PCs or servers, and straight-through cable for connections to switches or hubs.

However, when connecting to devices that support automatic MDI/MDI-X pinout configuration, you can use either straight-through or crossover cable.

Table B-1: 10/100BASE-TX MDI Port Pinouts

Pin	MDI Signal Name
1	Transmit Data plus (TD+)
2	Transmit Data minus (TD-)
3	Receive Data plus (RD+)
4	GND (Positive Vport)
5	GND (Positive Vport)
6	Receive Data minus (RD-)
7	-48V feeding power (Negative- Vport)
8	-48V feeding power (Negative- Vport)

Note: The "+" and "-" signs represent the polarity of the wires that make up each wire pair.

Straight-Through Wiring

Because the 10/100 Mbps port on the BSAP-1600 uses an MDI pin configuration, you must use "straight-through" cable for network connections to hubs or switches that only have MDI-X ports. However, if the device to which you are connecting supports auto-MDIX operation, you can use either "straight-through" or "crossover" cable.

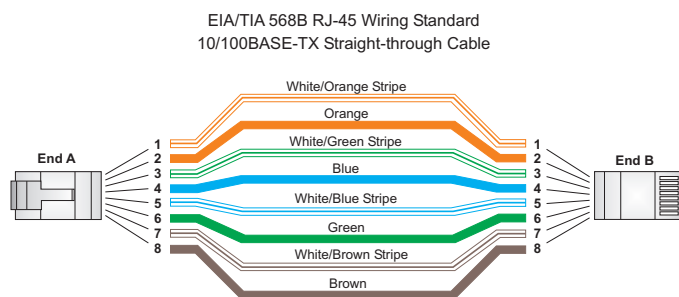

Crossover Wiring

Because the 10/100 Mbps port on the BSAP-1600 uses an MDI pin configuration, you must use "crossover" cable for network connections to PCs, servers or other end nodes that only have MDI ports. However, if the device to which you are connecting supports auto-MDIX operation, you can use either "straight-through" or "crossover" cable.

EIA/TIA 568B RJ-45 Wiring Standard
10/100BASE-TX Crossover Cable

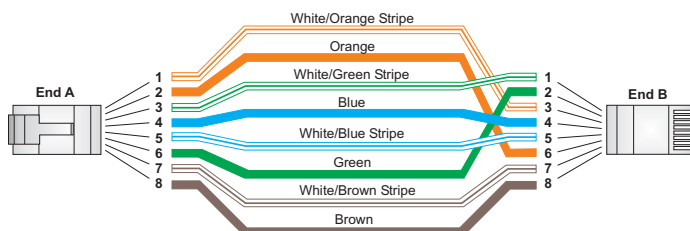

8-Pin DIN Connector Pinout

The Ethernet cable from the power injector connects to an 8-pin DIN connector on the BSAP-1600. This connector is described in the following figure and table.

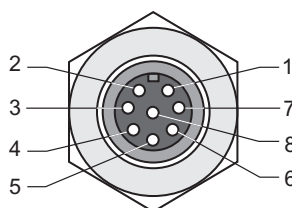

Table B-2: 8-Pin DIN Ethernet Port Pinout

Pin	Signal Name
1	Transmit Data plus (TD+)
2	Transmit Data minus (TD-)
3	Receive Data plus (RD+)
4	+48 VDC power
5	+48 VDC power
6	Receive Data minus (RD-)
7	Return power
8	Return power

Note: The "+" and "-" signs represent the polarity of the wires that make up each wire pair.

8-Pin DIN to RJ-45 Cable Wiring

To construct an extended Ethernet cable to connect from the power injector's RJ-45 Output port to the BSAP-1600's 8-pin DIN connector, follow the wiring diagram below. Use Category 5 or better UTP or STP cable, maximum length 100 m (328 ft), and be sure to connect all four wire pairs.

Note: To construct a reliable Ethernet cable, always use the proper tools or ask a professional cable supplier to construct the cable.

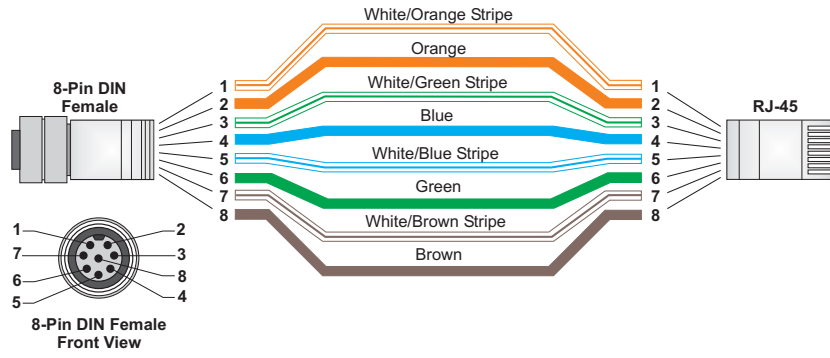

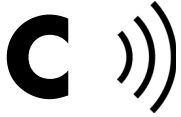

Specifications

General Specifications

Maximum Channels	802.11a: US & Canada: 13 (normal mode), 5 (turbo mode) Japan: 4 (normal mode), 1 (turbo mode) ETSI: 11 channels (normal mode), 4 (turbo mode) Taiwan: 8 (normal mode), 3 (turbo mode) 802.11b/g: FCC/IC: 1-11 ETSI: 1-13 France: 10-13 MKK: 1-14 Taiwan: 1-11
Maximum Clients	64 per VAP interface
Operating Range	See
Data Rate	802.11a: Normal Mode: 6, 9, 12, 18, 24, 36, 48, 54 Mbps per channel Turbo Mode: 12, 18, 24, 36, 48, 54, 96, 108 Mbps per channel 802.11g: 6, 9, 11, 12, 18, 24, 36, 48, 54 Mbps per channel 802.11b: 1, 2, 5.5, 11 Mbps per channel
Modulation Type	802.11a: BPSK, QPSK, 16-QAM, 64-QAM 802.11g: CCK, BPSK, QPSK, OFDM 802.11b: CCK, BPSK, QPSK
Network Configuration	Infrastructure
Operating Frequency	802.11a: 5.15 ~ 5.25 GHz (lower band) US/Canada, Japan 5.25 ~ 5.35 GHz (middle band) US/Canada

	5.725 ~ 5.825 GHz (upper band) US/Canada
	5.50~ 5.70 GHz Europe
	5.25 ~ 5.35 GHz (middle band) Taiwan
	5.725 ~ 5.825 GHz (high band) Taiwan
	802.11b:
	2.4 ~ 2.4835 GHz (US, Canada, ETSI)
	2.4 ~ 2.497 GHz (Japan)
	2.400 ~ 2.4835 GHz (Taiwan)
AC Power Adapter	Input: 100-240 AC, 50-60 Hz Output: 48 VDC, 1.2 A Power consumption: 13.2 watts
Unit Power Supply	PoE input: 48 VDC, 0.6 A maximum Power consumption: 28 watts maximum
Physical Size	19.5 x 19 x 7.4 cm (7.68 x 7.48 x 2.91 in)
Weight	1.54 kg (3.4 lbs)
LED Indicators	PWR (Power), Link (Ethernet Link/Activity), 11a and 11g (Wireless Link/Activity)
Network Management	Web-browser, RS232 console, Telnet, SSH, SNMP
Temperature	Operating: -40 to 60°C (-40 to 140 °F) non-condensing @ 5 to 50°C Storage: -55 to 80°C (-67 to 176 °F) non-condensing @ 5 to 70°C
Humidity	15% to 95% (non-condensing)
Safety	UL/CUL (CSA60950-1,UL60950-1) CB (IEC 60950-1) UL/GS (EN60950-1) Wireless Radio/Regulatory Certification ETSI 300 328 (11b/g), 301 893 (11a Full range), 301 489 (DC power) FCC Part 15C 15.247/15.207 (11b/g), Part 15E 15.407 (11a Full range) Wi-Fi DGT TELEC RSS210(Canada) C-Tick Electromagnetic Compatibility CE Class B (EN55022) CE EN55024,

IEC61000-3-2, IEC61000-3-3, IEC61000-4-2, IEC61000-4-3, IEC61000-4-4,
IEC61000-4-5, IEC61000-4-6, IEC61000-4-8, IEC61000-4-11

FCC Class B Part 15

VCCI Class B

ICES-003 (Canada)

Standards IEEE 802.3 10BASE-T, IEEE 802.3u 100BASE-TX,
IEEE 802.11a, b, g

Sensitivity

Table C-1: IEEE 802.11a Sensitivity (GHz - dBm)

Modulation/ Rates	5.15-5.250	5.25-5.350	5.50-5.700	5.725-5.825
BPSK (6 Mbps)	-89	-89	-91	-90
BPSK (9 Mbps)	-89	-89	-89	-88
QPSK (12 Mbps)	-88	-87	-87	-87
QPSK (18 Mbps)	-85	-85	-85	-84
16 QAM (24 Mbps)	-81	-81	-83	-80
16 QAM (36 Mbps)	-78	-78	-79	-77
64 QAM (48 Mbps)	-73	-73	-74	-71
64QAM(54 Mbps)	-71	-71	-72	-67

Table C-2: IEEE 802.11g

Data Rate	Sensitivity (dBm)
6 Mbps	-91
9 Mbps	-90
12 Mbps	-89
17 Mbps	-88
24 Mbps	-84
36 Mbps	-80
48 Mbps	-75
54 Mbps	-73

Table C-3: IEEE 802.11b

Data Rate	Sensitivity (dBm)
1 Mbps	-96
2 Mbps	-93
5.5 Mbps	-93
11 Mbps	-90

Transmit Power

Table C-4: IEEE 802.11a Maximum Output Power (GHz - dBm)

Data Rate	5.15-5.250	5.25-5.350	5.50-5.700	5.725-5.825
6 Mbps	18	18	18	18
9 Mbps	18	18	18	17
12 Mbps	18	18	18	17
8 Mbps	18	18	18	17
24 Mbps	18	18	18	17
36 Mbps	18	18	18	17
48 Mbps	17.5	17	17	16.5
54 Mbps	17.5	17	16.5	15

Table C-5: IEEE 802.11g Maximum Output Power (GHz - dBm)

Data Rate	2.412	2.417~2.467	2.472
6 Mbps	20	20	20
9 Mbps	20	20	20
12 Mbps	20	20	20
18 Mbps	20	20	20
24 Mbps	20	20	20
36 Mbps	19	19	18.5
48 Mbps	19	19	18.5
54 Mbps	18	18	18

Table C-6: IEEE 802.11b Maximum Output Power (GHz - dBm)

Data Rate	2.412	2.417~2.467	2.472
1 Mbps	20	20	20
2 Mbps	20	20	20
5.5 Mbps	20	20	20
11 Mbps	20	20	20

Operating Range

Important Notice

Maximum distances posted below are actual tested distance thresholds. However, there are many variables such as barrier composition and construction and local environmental interference that may impact your actual distances and cause you to experience distance thresholds far lower than those posted below.

Table C-7: 802.11a Wireless Distance Table - Speed and Distance Ranges

Environment	108 Mbps	72 Mbps	54 Mbps	48 Mbps	36 Mbps	24 Mbps	18 Mbps	12 Mbps	9 Mbps	6 Mbps
Outdoors ¹	30 m 99 ft	40 m 131 ft	85 m 279 ft	250 m 820 ft	310 m 1016 ft	400 m 1311 ft	445 m 1459 ft	455 m 1492 ft	465 m 1525 ft	510 m 1672 ft
Indoors ²	15 m 49.5 ft	20 m 66 ft	25 m 82 ft	35 m 115 ft	40 m 131 ft	45 m 148 ft	50 m 164 ft	55 m 180 ft	66 m 216 ft	70 m 230 ft

Table C-8: 802.11g Wireless Distance Table - Speed and Distance Ranges

Environment	54 Mbps	48 Mbps	36 Mbps	24 Mbps	18 Mbps	12 Mbps	11 Mbps	9 Mbps	6 Mbps	5 Mbps	2 Mbps	1 Mbps
Outdoors ¹	82 m 269 ft	100 m 328 ft	300 m 984 ft	330 m 1082 ft	350 m 1148 ft	450 m 1475 ft	470 m 1541 ft	485 m 1590 ft	495 m 1623 ft	510 m 1672 ft	520 m 1705 ft	525 m 1722 ft
Indoors ²	20 m 66 ft	25 m 82 ft	35 m 115 ft	43 m 141 ft	50 m 164 ft	57 m 187 ft	66 m 216 ft	71 m 233 ft	80 m 262 ft	85 m 279 ft	90 m 295 ft	93 m 305 ft

Table C-9: 802.11b Wireless Distance Table - Speed and Distance Ranges

Environment	11 Mbps	5.5 Mbps	2 Mbps	1 Mbps
Outdoors ¹	300 m 984 ft	465 m 1525 ft	500 m 1639 ft	515 m 1689 ft
Indoors ²	60 m 197 ft	70 m 230 ft	83 m 272 ft	85 m 279 ft

1. Outdoor Environment: A line-of-sight environment with no interference or obstruction between the BSAP-1600 and clients.
2. Indoor Environment: A typical office or home environment with floor to ceiling obstructions between the BSAP-1600 and clients.



Glossary

Numbers

10BASE-T. IEEE 802.3 specification for 10 Mbps Ethernet over two pairs of Category 3 or better UTP cable.

100BASE-TX. IEEE 802.3u specification for 100 Mbps Fast Ethernet over two pairs of Category 5 or better UTP cable.

A

Access Point. An internetworking device that seamlessly connects wired and wireless networks. Access points attached to a wired network, support the creation of multiple radio cells that enable roaming throughout a facility.

Ad Hoc. A group of computers connected as an independent wireless network, without an access point.

Advanced Encryption Standard (AES). An encryption algorithm that implements symmetric key cryptography. AES provides very strong encryption using a completely different ciphering algorithm to TKIP and WEP.

Authentication. The process to verify the identity of a client requesting network access. IEEE 802.11 specifies two forms of authentication: open system and shared key.

B

Backbone . The core infrastructure of a network. The portion of the network that transports information from one central location to another central location where it is unloaded onto a local system.

Basic Service Set (BSS). A set of 802.11-compliant stations and an access point that operate as a fully-connected wireless network.

Beacon. A signal periodically transmitted from the access point that is used to identify the service set, and to maintain contact with wireless clients.

Broadcast Key. Broadcast keys are sent to stations using 802.1X dynamic keying. Dynamic broadcast key rotation is often used to allow the access point to generate a random group key and periodically update all key-management capable wireless clients.

C

CSMA/CA. Carrier Sense Multiple Access with Collision Avoidance.

D

Dynamic Host Configuration Protocol (DHCP). Provides a framework for passing configuration information to hosts on a TCP/IP network. DHCP is based on the Bootstrap Protocol (BOOTP), adding the capability of automatic allocation of reusable network addresses and additional configuration options.

E

Encryption. Data passing between the access point and clients can use encryption to protect from interception and eavesdropping.

Extended Service Set (ESS). More than one wireless cell can be configured with the same Service Set Identifier to allow mobile users can roam between different cells with the Extended Service Set.

Extensible Authentication Protocol (EAP). An authentication protocol used to authenticate network clients. EAP is combined with IEEE 802.1X port authentication and a RADIUS authentication server to provide “mutual authentication” between a client, the access point, and the a RADIUS server

Ethernet. A popular local area data communications network, which accepts transmission from computers and terminals.

F

File Transfer Protocol (FTP). A TCP/IP protocol used for file transfer.

H

Hypertext Transfer Protocol (HTTP). HTTP is a standard used to transmit and receive all data over the World Wide Web.

I

IEEE 802.11a. A wireless standard that supports high-speed communications in the 5 GHz band using Orthogonal Frequency Division Multiplexing (OFDM). The standard supports data rates of 6, 12, 24, and 54 Mbps.

IEEE 802.11b. A wireless standard that supports wireless communications in the 2.4 GHz band using Direct Sequence Spread Spectrum (DSSS). The standard provides for data rates of 1, 2, 5.5, and 11 Mbps.

IEEE 802.11g. A wireless standard that supports wireless communications in the 2.4 GHz band using using Orthogonal Frequency Division Multiplexing (OFDM). The standard provides for data rates of 6, 9, 11, 12, 18, 24, 36, 48, 54 Mbps. IEEE 802.11g is also backward compatible with IEEE 802.11b.

IEEE 802.1X. Port Authentication controls access to the switch ports by requiring users to first enter a user ID and password for authentication.

Infrastructure. An integrated wireless and wired LAN is called an infrastructure configuration.

Inter Access Point Protocol (IAPP). A protocol that specifies the wireless signaling required to ensure the successful handover of wireless clients roaming between different 802.11f-compliant access points.

L

Local Area Network (LAN). A group of interconnected computer and support devices.

M

MAC Address. The physical layer address used to uniquely identify network nodes.

N

Network Time Protocol (NTP). NTP provides the mechanisms to synchronize time across the network. The time servers operate in a hierarchical-master-slave configuration in order to synchronize local clocks within the subnet and to national time standards via wire or radio.

O

Open System. A security option which broadcasts a beacon signal including the access point's configured SSID. Wireless clients can read the SSID from the beacon, and automatically reset their SSID to allow immediate connection to the nearest access point.

Orthogonal Frequency Division Multiplexing (OFDM). OFDM/ allows multiple users to transmit in an allocated band by dividing the bandwidth into many narrow bandwidth carriers.

P

Power over Ethernet (PoE). A specification for providing both power and data to low-power network devices using a single Category 5 Ethernet cable. PoE provides greater flexibility in the locating of access point's and network devices, and significantly decreased installation costs.

R

RADIUS. A logon authentication protocol that uses software running on a central server to control access to the network.

Roaming. A wireless LAN mobile user moves around an ESS and maintains a continuous connection to the infrastructure network.

RTS Threshold. Transmitters contending for the medium may not be aware of each other. RTS/CTS mechanism can solve this "Hidden Node Problem." If the packet size is smaller than the preset RTS Threshold size, the RTS/CTS mechanism will NOT be enabled.

S

Service Set Identifier (SSID). An identifier that is attached to packets sent over the wireless LAN and functions as a password for joining a particular radio cell; i.e., Basic Service Set (BSS).

Session Key. Session keys are unique to each client, and are used to authenticate a client connection, and correlate traffic passing between a specific client and the access point.

Shared Key. A shared key can be used to authenticate each client attached to a wireless network. Shared Key authentication must be used along with the 802.11 Wireless Equivalent Privacy algorithm.

Simple Network Management Protocol (SNMP). The application protocol in the Internet suite of protocols which offers network management services.

Simple Network Time Protocol (SNTP). SNTP allows a device to set its internal clock based on periodic updates from a Network Time Protocol (NTP) server. Updates can be requested from a specific NTP server, or can be received via broadcasts sent by NTP servers.

T

Temporal Key Integrity Protocol (TKIP). A data encryption method designed as a replacement for WEP. TKIP avoids the problems of WEP static keys by dynamically changing data encryption keys.

Trivial File Transfer Protocol (TFTP). A TCP/IP protocol commonly used for software downloads.

V

Virtual Access Point (VAP). Virtual AP technology multiplies the number of Access Points present within the RF footprint of a single physical access device. With Virtual AP technology, WLAN users within the device's footprint can associate with what appears to be different access points and their associated network services. All the services are delivered using a single radio channel, enabling Virtual AP technology to optimize the use of limited WLAN radio spectrum.

Virtual LAN (VLAN). A Virtual LAN is a collection of network nodes that share the same collision domain regardless of their physical location or connection point in the network. A VLAN serves as a logical workgroup with no physical barriers, and allows users to share information and resources as though located on the same LAN.

W

Wi-Fi Protected Access. WPA employs 802.1X as its basic framework for user authentication and dynamic key management to provide an enhanced security solution for 802.11 wireless networks.

Wired Equivalent Privacy (WEP). WEP is based on the use of security keys and the popular RC4 encryption algorithm. Wireless devices without a valid WEP key will be excluded from network traffic.

WPA Pre-shared Key (PSK). PSK can be used for small office networks that may not have the resources to configure and maintain a RADIUS server, WPA provides a simple operating mode that uses just a pre-shared password for network access.



Index

Numerics

802.11g 7-80

A

AES 6-69

authentication 6-10

 cipher suite 6-72, 7-100

 closed system 7-90

 configuring 6-10

 MAC address 6-11, 7-59, 7-60

 type 6-59, 7-90

 web redirect 6-12, 7-18

B

Basic Service Set See BSS 3-2

beacon

 interval 6-50, 7-86

 rate 6-50, 7-87

BOOTP 7-76, 7-77

BPDU 6-20

BSS 3-2

C

cable

 assignments B-1

 crossover B-2

 straight-through B-2

channel 7-83

channels, maximum C-1

Clear To Send See CTS 6-51

CLI 7-1

 command modes 7-4

clients, maximum C-1

closed system 6-45, 7-90

command line interface See CLI 7-1

community name, configuring 7-35

community string 6-35, 7-35

configuration settings, saving or restoring 6-27, 7-48

console port

 required settings 5-2

country code

- configuring 5-3, 7-11
- crossover cable B-2
- CSMA/CA 1-1
- CTS 6-51, 7-88

D

- data rate
 - maximum distances C-5
- data rate, options C-1
- device status, displaying 6-75, 7-20
- DHCP 6-4, 6-5, 7-76, 7-77
- distances, maximum C-5
- DNS 6-5, 7-76
- Domain Name Server See DNS 6-5, 7-76
- downloading software 6-25, 7-48
- DTIM 6-50, 7-87
- Dynamic Host Configuration Protocol See DHCP 6-4

E

- EAP 6-68
- encryption 6-60, 6-64, 6-69
- Ethernet
 - port 1-5
- event logs 6-79, 6-81, 7-29
- Extensible Authentication Protocol See EAP 6-68

F

- factory defaults
 - restoring 6-27, 7-9
- filter 6-14, 7-59
 - address 6-10, 7-59
 - between wireless clients 7-62
 - local bridge 7-62
 - local or remote 6-10, 7-60
 - management access 6-15, 7-63
 - protocol types 6-15, 7-63
 - VLANs 6-45, 7-110
- firmware
 - displaying version 6-26, 7-21
 - upgrading 6-25, 6-26, 7-48
- fragmentation 7-87

G

- gateway address 5-2, 6-5, 7-2, 7-76

H

- hardware version, displaying 7-21
- HTTP, secure server 7-17
- HTTPS 7-17

I

- IAPP 7-109

- IEEE 802.11a 1-1, 6-43, 7-80
 - configuring interface 6-44, 7-80
 - maximum data rate 7-82
 - radio channel 7-83
- IEEE 802.11b 6-43
- IEEE 802.11f 7-109
- IEEE 802.11g 6-43
 - configuring interface 6-57, 7-80
 - maximum data rate 7-82
 - radio channel 6-58, 7-83
- IEEE 802.1x 6-68, 7-55, 7-59
 - configuring 6-73, 7-55
- IP address
 - BOOTP/DHCP 7-76, 7-77
 - configuring 5-2, 6-4, 7-76, 7-77

L

- log
 - messages 6-29, 6-79, 6-81, 7-27
 - server 6-28, 7-27
- login
 - CLI 7-1
 - web 5-3
- logon authentication
 - RADIUS client 6-12, 7-50

M

- MAC address, authentication 6-11, 7-59, 7-60
- maximum associated clients 6-49
- maximum data rate 7-82
 - 802.11a interface 7-82
 - 802.11g interface 7-82
- maximum distances C-5
- MDI, RJ-45 pin configuration 1-6

N

- network topologies
 - infrastructure 3-2
 - infrastructure for roaming 3-2

O

- OFDM 1-1
- open system 6-59, 7-90
- operating frequency C-1

P

- package checklist 1-2
- password
 - configuring 6-24, 6-25, 6-27, 7-14
 - management 6-24, 6-25, 6-27, 7-14
- PoE 2-6
 - specifications C-2

- port priority
 - STA 7-74
- Power over Ethernet See PoE 2-6
- power supply, specifications C-2
- PSK 6-69

R

- radio channel
 - 802.11a interface 7-83
 - 802.11g interface 6-58, 7-83
- RADIUS 6-6, 6-68, 7-50
- RADIUS, logon authentication 6-12, 7-50
- Related Documentation v-xxi
- Remote Authentication Dial-in User Service See RADIUS 6-6
- Request to Send See RTS 6-51
- reset 6-27, 7-9
- reset button 1-6, 6-27
- resetting the access point 6-27, 7-9
- restarting the system 6-27, 7-9
- RJ-45 port
 - configuring duplex mode 7-77
 - configuring speed 7-77
- RSSI BNC 1-6
- RTS
 - threshold 6-51, 7-88

S

- Secure Socket Layer See SSL 7-17
- security, options 6-59, 6-60
- session key 6-73, 6-74, 7-56
- shared key 6-65, 7-101
- Simple Network Time Protocol See SNTP 6-30
- SNMP 6-34, 7-35
 - community name 7-35
 - community string 7-35
 - enabling traps 6-35, 7-37
 - trap destination 6-35, 7-37
 - trap manager 6-35, 7-37
- SNTP 6-30, 6-31, 7-30
 - enabling client 6-31, 7-31
 - server 6-31, 7-30
- software
 - displaying version 6-25, 6-75, 7-21
 - downloading 6-26, 6-27, 7-48
- SSH
 - server Status 6-10
- SSID 6-64, 7-89
- SSL 7-17
- STA
 - interface settings 7-73
 - path cost 7-73
 - port priority 7-74
- startup files, setting 7-47

- station status 6-77, 7-94
- status
 - displaying device status 6-75, 7-20
 - displaying station status 6-77, 7-94
- straight-through cable B-2
- system clock, setting 6-31, 7-31
- system log
 - enabling 6-28, 7-27
 - server 6-28, 7-27
- system software, downloading from server 6-25, 7-48

T

- Telnet
 - for managenet access 7-1
- Temporal Key Integrity Protocol See TKIP 6-69
- time zone 6-31, 7-32
- TKIP 6-69
- transmit power, configuring 6-49, 7-83
- trap destination 6-35, 7-37
- trap manager 6-35, 7-37

U

- upgrading software 6-25, 7-48
- user name, manager 6-25, 7-14
- user password 6-25, 7-14

V

- VLAN
 - configuration 6-45, 7-110
 - native ID 6-45

W

- WEP 6-64
 - configuring 6-64
 - shared key 6-65, 7-101
- Wi-Fi Multimedia See WMM 7-112
- Wi-Fi Protected Access See WPA 6-68
- Wired Equivalent Protection See WEP 6-64
- WPA 6-68
 - pre-shared key 6-72, 7-104
- WPA, pre-shared key See PSK 6-69

