



Express XRT 128 kbps ISDN Modem

User Guide

61200153L3	Express XRT ST, Two Phone Ports
336048VUR-2	Express XRT Power Supply, 48 Vdc U.S. (110V)
336048VUR-3	Express XRT Power Supply, 48 Vdc Euro Style (240V)
336048VUR-4	Express XRT Power Supply, 48 Vdc U.K. Style (230V)
336048VUR-5	Express XRT Power Supply, 48 Vdc Aust Style (240V)

61202.153L3-1A
February 1998

Trademarks

- Express XR, Express XRT, and Express Configuration Wizard are trademarks of ADTRAN, Inc.
- Hayes is a registered trademark of Hayes Microcomputer Products, Inc.
- HyperACCESS is a registered trademark of Hilgraeve Inc.
- MicroPhone Pro is a trademark of Software Ventures Corporation.
- PROCOMM PLUS is a registered trademark of Datastorm Technologies, Inc.
- ReachOut is a registered trademark of hi/fn.
- Windows is a registered trademark and Windows NT is a trademark of Microsoft Corporation.
- pcANYWHERE is a trademark of Symantec Corporation.

The Express XR and Express XRT incorporate Synchronous Data Compression based on either IBM or hi/fn proprietary intellectual property, depending on the time of manufacture. The following trademarks and copyrights are applicable:

Stacker LZS Compression
Copyright © 1989 Carnegie Mellon University
All rights reserved.

Redistribution and use in source and binary forms are permitted provided that the above copyright notice and this paragraph are duplicated in all such forms and that any documentation, advertising materials, and other materials related to such distribution and use acknowledge that the software was developed by Carnegie Mellon University. The name of the University may not be used to endorse or promote products derived from this software without specific prior written permission. This software is provided "as is" and without any express or implied warranties, including, without limitation, the implied warranties of merchantability and fitness for a particular purpose.

hi/fn
5993 Avenida Encinas
Carlsbad, CA

STACKER
LZS
COMPRESSION

ADTRAN

Explorer Boulevard
P.O. Box 140000
Huntsville, AL 35814-4000
Phone: (205) 963-8000

© 1998 ADTRAN, Inc.
All rights reserved.
Printed in USA.

FCC regulations require that the following information be provided to the customer in this manual.

1. If your telephone equipment (Express XRT) causes harm to the telephone network, the Telephone Company may discontinue your service temporarily. If possible, they will notify you in advance. But if advance notice isn't practical, you will be notified as soon as possible. You will be advised of your right to file a complaint with the FCC.
2. Your telephone company may make changes in its facilities, equipment, operations, or procedures that could affect the proper operation of your equipment. If they do, you will be given advance notice so as to give you an opportunity to maintain uninterrupted service.
3. If you experience trouble with this equipment (Express XRT), please contact ADTRAN (see the inside back cover) for repair/warranty information. The telephone company may ask you to disconnect this equipment from the network until the problem has been corrected, or until you are sure the equipment is not malfunctioning.
4. This unit contains no user-serviceable parts.
5. This equipment complies with Part 68 of the FCC Rules. On the bottom of this equipment is a label that contains, among other information, the FCC registration number for this equipment. If requested, provide this information to your telephone company.
6. An FCC compliant telephone cord with a modular plug is provided with this equipment. In addition, an FCC compliant cable appropriate for the dial backup option ordered is provided with this equipment. This equipment is designed to be connected to the telephone network or premises wiring using an FCC compatible modular jack, which is Part 68 compliant.
7. The following information may be required when applying to the local telephone company for leased line facilities.

Service Type	Service Order Code
---------------------	---------------------------

ISDN	6.0P
------	------

**FEDERAL COMMUNICATIONS COMMISSION
RADIO FREQUENCY INTERFERENCE STATEMENT:**

This equipment has been tested and found to comply with the limits for a Class B digital device, pursuant to Part 15 of the FCC Rules. These limits are designed to provide reasonable protection against harmful interference when the equipment is operated in a commercial environment. This equipment generates, uses, and can radiate radio frequency energy and, if not installed and used in accordance with the instructions, may cause harmful interference to TV or radio reception, which can be determined by turning the equipment on and off. The user is encouraged to try to correct the interference by one or more of the following methods:

- Reorient or relocate the receiving antenna.
- Increase the separation between the equipment and receiver.
- Connect the equipment into an outlet on a circuit different from that to which the receiver is connected.
- Consult the dealer or an experienced radio/TV technician for help.

Changes or modifications to this unit not expressly approved by ADTRAN will void the user's authority to operate the equipment.

CANADIAN EMISSIONS REQUIREMENTS

This digital apparatus does not exceed the Class B limits for radio noise emissions from digital apparatus as set out in the interference-causing equipment standard entitled "Digital Apparatus," ICES-003 of the Department of Communications.

Cet appareil numérique respecte les limites de bruits radioélectriques applicables aux appareils numériques de Class B prescrites dans la norme sur le matériel brouilleur: "Appareils Numériques," NMB-003 édictée par le ministre des Communications.

CANADIAN EQUIPMENT LIMITATIONS

Notice: The Canadian Industry and Science Canada label identifies certified equipment. This certification means that the equipment meets certain telecommunications network protective, operational, and safety requirements. The Department does not guarantee the equipment will operate to the user's satisfaction.

Before installing this equipment, users should ensure that it is permissible to be connected to the facilities of the local telecommunications company. The equipment must also be installed using an acceptable method of connection. In some cases, the company's inside wiring associated with a single line individual service may be extended by means of a certified connector assembly (telephone extension cord). The customer should be aware that compliance with the above conditions may not prevent degradation of service in some situations.

Repairs to certified equipment should be made by an authorized Canadian maintenance facility designated by the supplier. Any repairs or alterations made by the user to this equipment, or equipment malfunctions, may give the telecommunications company cause to request the user to disconnect the equipment.

Users should ensure for their own protection that the electrical ground connections of the power utility, telephone lines and internal metallic water pipe system, if present, are connected together. This precaution may be particularly important in rural areas.

Caution: Users should not attempt to make such connections themselves, but should contact the appropriate electric inspection authority, or an electrician, as appropriate.

The Load Number (LN) assigned to each terminal device denotes the percentage of the total load to be connected to a telephone loop which is used by the device, to prevent overloading. The termination on a loop may consist of any combination of devices subject only to the requirement that the total of the Load Numbers of all devices does not exceed 100.

WARRANTY: ADTRAN warrants that items manufactured by ADTRAN and supplied under Buyer's order shall be free from defects in materials and workmanship and will conform to applicable specifications and drawings. ADTRAN's liability herein, whether based upon breach of warranty or contract or negligence in manufacture, shall be limited to replacement or repair at ADTRAN's election of all such defective or nonconforming items, provided that this warranty shall apply only where Buyer has given ADTRAN written notice of such defects or nonconformity within five (5) years* after delivery by ADTRAN of such items to Buyer. ADTRAN shall have the right prior to return to inspect at Buyer's plant any items claimed to be defective or nonconforming.

*Note: The following items carry warranty period as shown.

1. Items not of ADTRAN manufacture will carry the remaining warranty and related terms and conditions of the original manufacturer.
2. Encapsulated U-Repeater and Encapsulated DDS Repeater - 2 years.

The foregoing constitutes the sole and exclusive remedy of the Buyer and exclusive liability of ADTRAN AND IS IN LIEU OF ANY AND ALL OTHER WARRANTIES EXPRESSED OR IMPLIED OR STATUTORY AS TO MERCHANTABILITY, FITNESS FOR PURPOSE SOLD, DESCRIPTION, QUALITY, PRODUCTIVENESS OR ANY OTHER MATTER. Without limiting the foregoing, in no event shall ADTRAN be liable for the loss of use or profit or other collateral, special or consequential damages.

RETURNS: Return authorization must be obtained from ADTRAN prior to return of any items, including those for repair. Buyer's right to repair or replacement are governed by this Warranty. Issuance of credit for returned items shall be made at ADTRAN's discretion upon Buyer's request. All returns for credit accepted by ADTRAN are subject to a restocking fee.

SHIPPING: The cost of shipping the equipment from Buyer's facility back to ADTRAN shall be paid by the Buyer. The cost for return shipping of the equipment by surface carrier shall be paid by ADTRAN. ADTRAN will utilize other means of express shipment at the request of the Buyer. The cost of shipping shall be paid by the Buyer if express shipment is requested. In-warranty equipment returned for repair that is found not defective will carry a nominal charge to cover handling cost.

OUT OF WARRANTY: The cost of out-of-warranty repairs including return shipment are subject to a charge as quoted by ADTRAN. The cost of the repair will be invoiced and the return of the item will be made using the most economical shipment means available. ADTRAN will use other means of express shipment at the request of the Buyer. In this case, the cost of shipping shall be paid by the Buyer.

ALTERATION TO EQUIPMENT PURCHASED: Modification or alteration to purchased equipment by Buyer, other than that specifically authorized by this Agreement or by ADTRAN, shall VOID AND NULLIFY, in its entirety, all warranty conditions as set forth in Warranty paragraph.

ENGINEERING CHANGES: ADTRAN reserves the right to make progress and design changes in standard product items ordered without prior approval or notification to Buyer and without incurring any obligations or liability to make the same changes in items previously manufactured.

DATA RIGHTS: Rights to any intellectual property residing in the products or any data furnished hereunder are not granted except by specific written permission by an authorized representative of ADTRAN. Buyer shall have no right to copy or reproduce in whole or part any data furnished hereunder without the prior written consent of ADTRAN.

PATENT AND COPYRIGHT INDEMNITY: ADTRAN warrants that the equipment and documentation furnished under this Agreement shall be free and clear of infringement of any patent or copyright covering the structure or composition of such articles or documentation. In the event of a claim, suit or action against Buyer alleging such infringement, ADTRAN shall save Buyer and its affiliates, agents or customers harmless from liability as finally determined by a court of competent jurisdiction, for such infringement, provided that Buyer gives ADTRAN notice promptly of

such claim, suit or action, and shall have given ADTRAN full and exclusive control of the defense thereof, and that ADTRAN shall have sole right to settle or compromise such claim, suit or action.

In the event of a claim, suit or action against ADTRAN alleging infringement by the use of any such equipment or documentation, furnished under this Agreement, in combination with other articles or in carrying out any process covered by a patent owned or controlled by any other person, in which independent use of the equipment under this Agreement would not be an infringement. Buyer shall save ADTRAN harmless from liability, as finally determined by a court of competent jurisdiction, for such infringement, provided that ADTRAN shall have given Buyer full and exclusive control of the defense thereof, and that Buyer shall have the sole right to settle claim, suit or action.

Except as here in provided in this indemnity paragraph, neither Buyer nor ADTRAN makes any warranty to the other with respect to any claim, suit or action of any third party by way of infringement and neither party shall be responsible to the other for any loss, cost or damages consequential or otherwise, that may be suffered by the other as a result of any such claim, suit or action.

Telephone Company Contacts for ISDN Service

Ameritech ISDN Repair	1-800-TEAMDATA
Bell Atlantic	1-800-570-ISDN
Bell South	1-800-247-2020
Cincinnati Bell	1-513-241-6900
NYNEX	1-800-GET-ISDN 1-800-430-ISDN (New England Area)
Pac Bell	1-800-4PB-ISDN
Rochester Tel	1-716-777-1811
Southwestern Bell	1-800-792-4736
US West	1-800-223-7508

Table of Contents

Chapter 1: Overview	1
Getting Started	1
Minimum Requirements	2
What You Provide	2
For a PC	2
For a Macintosh	2
General Requirements (for both PCs and Macintosh)	2
What ADTRAN Provides	3
Chapter 2: Installation	5
Verify Switch Settings	5
Connecting the Express XRT	6
Express XRT Software Installation	7
Microsoft Windows 95 and Windows NT 4.0	8
Windows 95 Plug and Play	8
Windows 95/Windows NT 4.0 Control Panel Modem Installation	8
Express Configuration Wizard Installation for Microsoft Windows 95 and Windows NT 4.0	9
Get On With It!	10
Microsoft Windows 3.1 and Windows NT 3.51	10
Windows NT 3.51 INF File Installation	11
Express Configuration Wizard Installation for Microsoft Windows 3.1 and Windows NT 3.51	11
Get On With It!	12
Macintosh Installation	12
Basic Telephone Service	13
Supplementary Voice Services	13
Call Waiting	13
Conference Calling	13
Automatic Redial	14
Phone Number Allocation	14
Single Phone Number Operation	14
Using the Express Configuration Wizard	15
For Windows 95 and Windows NT 4.0:	15
For Windows 3.x and Windows NT 3.51:	15
For the Macintosh operating system:	15
Auto-Detect SPIDs/Switch Type (Expert ISDN)	18

Table of Contents

Using the Express Configuration Wizard Help	19
Express Configuration Wizard Tray Tool.....	19
Express Configuration Tray Tool Menu	22
Enable/Disable Modem	22
Properties	22
Refresh	22
About	22
Exit.....	23
Installing Windows 95 Dial-Up Networking	23
VT 100 Configuration.....	24
VT 100 Terminal Status Buffer.....	25
Chapter 3: Installing an Analog Modem.....	27
Connecting an External Analog Modem.....	28
Installing a New External Analog Modem	29
Configuring an External Analog Modem	30
Required External Analog Modem Settings	30
Controlling an External Analog Modem	31
Express Configuration Wizard Modem Enable.....	31
Express Configuration Wizard Modem Disable.....	33
Terminal Emulation Modem Enable	33
Terminal Emulation Modem Disable	35
Connecting an Internal Analog Modem	36
Chapter 4: Application Configuration.....	37
Profile Configurations	38
Factory: PPP 64k (Internet)	38
Factory: Multilink PPP 128k (Internet)	38
Factory: V.120 64k (Remote Access)	39
Factory: Async BONDING 128k (Remote Access)	39
Express Configuration Wizard.....	39
Starting the Express Configuration Wizard Software.....	39
Internet and Remote Access.....	40
Creating a Custom Profile.....	40
Defining a User Program Button	42
Inactivity Timer	44
Calling Features Options.....	44
Message Waiting Indicator	44
Flash/Hook Default.....	45
Incoming Voice Call Options	45
Call Routing	45
All Calls to DTE.....	45
Speech calls to POTS.....	45
Speech/Audio calls to POTS	45
Enable Call Rejection List	45
Enable Anonymous Call Rejection	45
BBS Applications	46
Defining a Custom HyperACCESS Session	46
Shiva Password Authentication Protocol (SPAP)	47

Chapter 5: Upgrading Software	49
HyperACCESS	51
For Windows 95 and Windows NT 4.0:	51
For Windows 3.1 and Windows NT 3.51:	51
Chapter 6: Troubleshooting.....	53
Power/Line LED is Off.....	53
Power/Line LED Flashes and B1 and B2 LEDs are Off.....	53
Power/Line LED, B1, and B2 LEDs Flash Green.....	54
Dial-Up Connection Problems.....	55
Auto-detect Switch/SPIDs Remains at Link Down	55
Express XRT Not Detected	55
External Analog Modem Not Detected.....	56
Difficulty with 230.4 kbps Operation	56
Dial-Up Networking Difficulty	56
Appendix A: AT Commands and S-Registers.....	57
Using an AT Command.....	58
Using S-Registers.....	58
Reading an S-Register	58
Reading an S-Register String	58
Changing an S-Register	58
Changing a String S-Register	59
Dialing a Call using the AT Command Processor	59
Appendix B: LEDs	71
Appendix C: Status Buffer Messages	73
Appendix D: Loop Status Messages	83
Appendix E: Connector Pinouts.....	87
List of Figures	
Figure 1-1: Express XRT Contents	3
Figure 2-1: Dip Switches on Rear Panel.....	6
Figure 2-2: Standard ISDN Internet/Remote Access Application	7
Figure 2-3: Installation Options	10
Figure 2-4: Unable to Auto-Detect	15
Figure 2-5: Express Configuration Automatic Guide option	16
Figure 2-6: Express Wizard Configuration Start Screen	17
Figure 2-7: Express Wizard Configuration Tab.....	17
Figure 2-8: Express Configuration Wizard Connection Tab	18
Figure 2-9: Express Configuration Wizard Tray Tool	20
Figure 2-10: Preferences Tab	20
Figure 2-11: Express XRT Disabled, External Analog Modem Enabled	21

Table of Contents

Figure 2-12:	Express XRT Enabled, External Analog Modem Disabled.....	21
Figure 2-13:	Unknown State.....	21
Figure 2-14:	Express Configuration Wizard Tray Tool Menu.....	22
Figure 2-15:	VT 100 Terminal Configuration Menu	25
Figure 2-16:	VT 100 Terminal Status Buffer Menu.....	26
Figure 3-1:	External Analog Modem Application.....	28
Figure 3-2:	Express Configuration Wizard: Connecting an External Modem.....	32
Figure 3-3:	No Modem Attached Error Message	32
Figure 3-4:	HyperACCESS: Verifying External Modem Connection	34
Figure 3-5:	HyperACCESS: Enabling an External Analog Modem	34
Figure 3-6:	HyperACCESS: Disabling an External Analog Modem	35
Figure 3-7:	Internal Analog Modem Application	36
Figure 4-1:	ISDN Setup Tab.....	41
Figure 4-2:	Protocol Tab.....	42
Figure 4-3:	Advanced Tab	43
Figure 4-4:	Calling Features Tab.....	44
Figure 5-1:	Diagnostics Tab	50
Figure 5-2:	Upgrade Firmware Dialog Box.....	50
Figure 5-3:	HyperACCESS Communications Dialog Box	51
Figure 5-4:	Send Dialog Box	52
Figure B-1:	Front Panel LEDs	71
Figure E-1:	RS-232 Interface.....	87
Figure E-2:	Modem Interface	88
Figure E-3:	Express XRT Ground Pinouts	90

List of Tables

Table B-A:	Express XRT LEDs.....	71
Table E-A:	RS-232 Interface	87
Table E-B:	Modem Interface.....	88
Table E-C:	RJ-11 POTS Port Interface.....	89
Table E-D:	RJ-45 ISDN Line Interface	89

Chapter 1

Overview

EXPRESS XRT OVERVIEW

The Express XRT™ provides high speed network access for Internet and remote office connectivity using ISDN.

The Express XRT provides the following features:

- Data rates up to 230.4 kbps - over eight times faster than a V.34 analog modem
- Simple setup with the Express Configuration Wizard™
- Automatic SPID and Switch Detection for use in North America (covered under patent number 5,715,241)
- LZS® technology from hi/fn™ for compression up to 230.4 kbps
- Remote configuration
- Windows® Plug and Play compatibility
- Connections for two analog devices
- External analog modem support - no additional COM port required (patent pending)
- Custom calling features and Caller ID support using the GUI
- RJ-45 connector for ISDN Basic Rate S/T interface
- Two standard RJ-11s (RFN=3) Analog Phone Ports
- RS-232 (DB-25) External Modem Connector
- RS-232 (DB-25) DTE interface

Getting Started

This User Guide describes how to install, operate, and troubleshoot the Express XRT ISDN modem.

Minimum Requirements

What You Provide

In order to operate the Express XRT, the following items are required:

For a PC

- Personal computer 386 or higher
- Windows 95, or Windows NT 3.51
- Approximately 1.5 MB free disk space

For a Macintosh

- Power PC or 68020 Processor
- Approximately 2 MB free disk space
- Macintosh high-speed cable

General Requirements (for both PCs and Macintosh)

- 16550 UART high speed serial port (16650 UART required for data speed of 230.4 kbps)
- RS-232 serial cable with a DB-25 connector for the Express XRT and the other end matching the COM port on the computer (do not use a null modem cable)
- One Basic Rate ISDN line (two ISDN phone numbers, sometimes referred to as local directory numbers)



NOTE

Single ISDN phone number and point-to-point lines are not recommended for use with the Express XRT.

What ADTRAN Provides

The ADTRAN Express XRT is packaged with the following contents (see Figure 1-1):

- Express XRT
- ADTRAN Express XRT User Guide
- ADTRAN Express Configuration Wizard software for Windows 95, Windows NT, and Macintosh (2 disks)
- AC power supply
- RJ-45 to RJ-45 cable

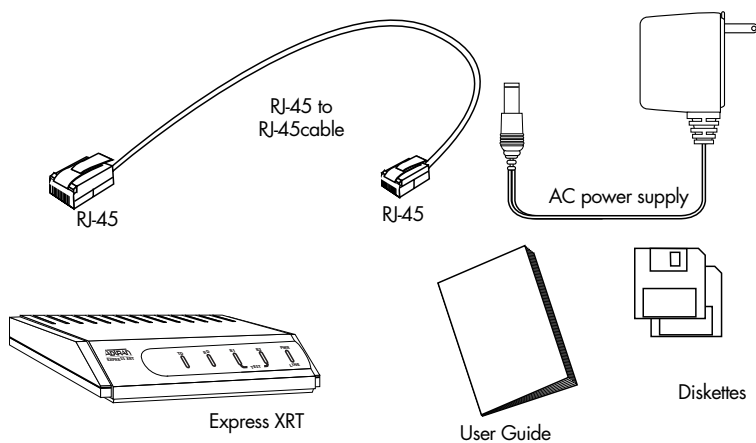

Figure 1-1
Express XRT Contents

Chapter 2

Installation

INSTALLING THE ADTRAN EXPRESS XRT

This section describes how to connect the Express XRT to a computer and how to install the Express Configuration Wizard software.

Verify Switch Settings

Dip switches 1 and 2 located on the rear panel of the Express XRT allow you to physically configure certain settings. Figure 2-1 on page 6 shows the location of the dip switches on the rear panel of the unit.



The factory default position for all switches is On (down) during initial installation.

SW 1: Off (up) = 230.4 kbps
 On (down) = Autobaud (speeds up to 115.2 kbps)

If dip switch 1 is set to the Off position (up), the unit is set to operate at a DTE speed of 230.4 kbps. A special serial COM port using a 16650 UART is required while in this mode. If switch 1 is set to the On position (down), the unit will automatically adapt to the DTE rate (up to 115.2 kbps).



*In order to configure the Express XRT to operate at 230.4 kbps with Windows 95 or Windows NT 4.0 Dial-Up Networking, a new modem must be added from the **Modems** icon in the Control Panel. Enter the name for this new connection and select **ADTRAN Express XRT 230.4 Kbps & 16650 UART**. See the section *Installing Windows 95 Dial-Up Networking* on page 23.*

SW 2: Off (up) = Factory Default
On (down) = Normal (previous settings saved)

If dip switch 2 is set to the Off (up) position, the unit continues to use the factory default settings until Switch 2 is set to the On (down) position. Also, area code, phone numbers, SPIDS, and stored numbers are cleared.

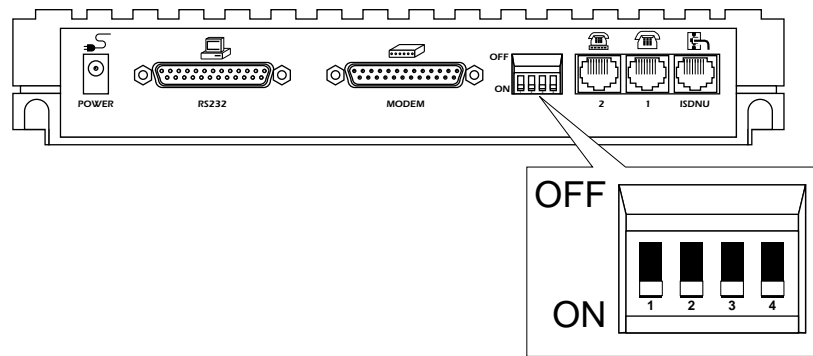
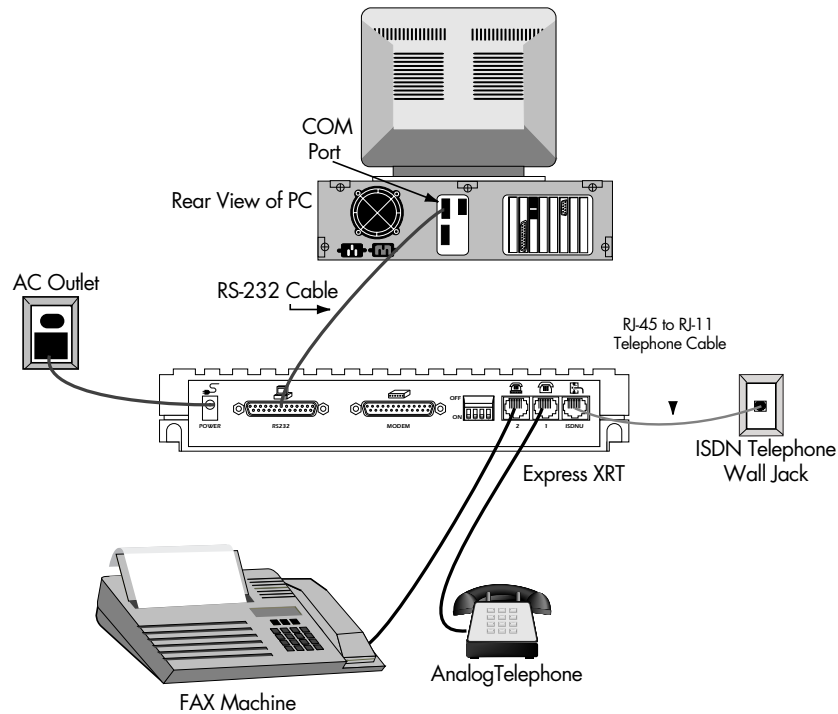

Figure 2-1
Dip Switches on Rear Panel

Connecting the Express XRT

1. Turn the computer off.
2. Using an RS-232 cable (see the section *Minimum Requirements* on page 2), connect the end with the DB-25 connector to the port labeled **RS232** on the Express XRT rear panel.
3. Connect the other end of the RS-232 cable to an available serial COM port on the computer.
4. Plug the small round end of the AC power cord into the jack labeled **POWER** on the Express XRT rear panel.
5. Place the AC power cord plug into an electrical outlet. The Express XRT is now powered on.
6. Plug the RJ-45 cable into the jack labeled **ISDN** on the rear of the Express XRT.
7. Plug the other end of the cable into the NT1. At this time the Express XRT is powered on and the **PWR LED** should either be flashing or on solid. See the section *LEDs* on page 71 for more information.

8. Power on the computer.
9. Go to the *Express XRT Software Installation* section.

**Figure 2-2**

Standard ISDN Internet/Remote Access Application

Express XRT Software Installation

The installation procedure varies depending on whether you are using a PC or a Macintosh. If the computer is not already on, power on the computer, start Microsoft Windows (for a PC) and use the following installation procedure that applies to your computer and operating system.

Microsoft Windows 95 and Windows NT 4.0

Windows 95 Plug and Play

1. During the Windows 95 boot process, if the **New Hardware Found** screen appears indicating **ADTRAN Express XRT**, select **Driver from disk provided by hardware manufacturer**. If the Windows 95 **New Hardware Found** screen does not appear, skip the rest of this section and go to *Windows 95/Windows NT 4.0 Control Panel Modem Installation* on page 8.
2. Insert the disk labeled **Windows 95 and Windows NT** into the 3.5" floppy disk drive.
3. Click **OK**. The **Install From Disk** screen should appear.
4. Click **OK** or use **Browse** to locate the correct disk drive.
5. Select **ADTRAN Express XRT** from the **Drivers** list.
6. Click **OK**. Windows installs the INF file and a modem labeled **ADTRAN XRT** on the COM port to which the unit is connected.
7. Check for the device. From **Start**, choose **Settings**, then **Control Panel**, then double click **Modems**.
8. The ADTRAN Express XRT should be listed under the General tab in the **Modems Properties** dialog box.
9. Click **OK**.
10. Click **Close**.
11. Go to *Express Configuration Wizard Installation for Microsoft Windows 95 and Windows NT 4.0* on page 9.

Windows 95/Windows NT 4.0 Control Panel Modem Installation

For Windows NT 4.0, you must be a member of the **Administrator Group** to install a new modem.

1. From the **Start** button, choose **Settings**, then choose **Control Panel**, then double click **Modems**.
2. If a modem has not been installed on the computer previously, the modem installation process begins immediately. From this menu, choose **Add** to begin installation of the Express XRT.
3. In the **Install New Modem** dialog box, check **Don't detect my modem; I will select it from a list**.
4. Click **NEXT**.
5. Click the **Have Disk** button.

6. Insert the disk labeled **Windows 95 and Windows NT** into the 3.5" floppy disk drive.
7. Click **OK**.
8. Select **ADTRAN Express XRT** from the **Drivers** list.
9. Click **NEXT**.
10. Choose the COM port to which the Express XRT is attached from the list of available COM ports.
11. Click **NEXT**.
12. Continue the installation by providing country, area code, and outside line access information as prompted.
13. Click **NEXT**.
14. Click **Finish** to complete the modem installation process.
15. Select **Close**.
16. Go to the next section.

Express Configuration Wizard Installation for Microsoft Windows 95 and Windows NT 4.0

The Express Configuration Wizard is a graphical user interface which allows you to configure and test the Express XRT with ease. Follow the installation procedure that applies to the operating system.

1. From the **Start** button, choose **Settings**, then **Control Panel**, then double click **Add/Remove Programs**.
2. From the **Install/Uninstall** tab, select the **Install** button.
3. Insert the disk labeled **Windows 95 and Windows NT**.
4. Click **NEXT**.
5. If the disk is found, click **Finish**; otherwise use **Browse** to first locate the disk. The Express Configuration Wizard begins installation.
6. Follow the step-by-step screen instructions throughout the installation process. Two options are available for installation during the Express Configuration Wizard installation: **Express Configuration Program** and **INF Files**. Figure 2-3 on page 10 illustrates the two options.



Figure 2-3
Installation Options

By default, the Express Configuration Wizard and INF files are installed.

Once installation is complete, an **ADTRAN** group is created and placed in the **Programs** menu on the **Start** button. The software can be started by choosing the **Express Configuration Wizard** icon or by double clicking on the **ADTRAN Express Configuration** icon located on the control panel.

Get On With It!

Go to the section *Using the Express Configuration Wizard* on page 15.

Microsoft Windows 3.1 and Windows NT 3.51

If running Windows 3.1, or version 1.2 or later of the Express Configuration Wizard, skip the next section, *Windows NT 3.51 INF File Installation*, and go to *Express Configuration Wizard Installation for Microsoft Windows 3.1 and Windows NT 3.51* on page 11.



If running Windows NT 3.51, install remote access service before following the INF file installation procedure.

Windows NT 3.51 INF File Installation

To install an ADTRAN Express XRT, use the following procedure:

1. Locate the **modem.inf** file. This file is normally located in the **c:\winnt35\system32\ras** directory. See the Windows NT documentation for instructions on installing the Remote Access Service.
2. In order to recover in case of a user mistake, create a backup of the **modem.inf** file.
3. Using Notepad or another text editor, open the **adtran.inf** file on the Express Configuration Wizard disk labeled **Windows 95 and Windows NT**.
4. Copy the contents of the **adtran.inf** file to the Windows clipboard.
5. Open the **modem.inf** file.
6. Paste the contents of the clipboard (**adtran.inf**) to the end of the **modem.inf** file.
7. Save the altered **modem.inf** file.
8. Close the **modem.inf** file.
9. Restart the system.
10. Go to *Express Configuration Wizard Installation for Microsoft Windows 3.1 and Windows NT 3.51* on page 11.

The Express XRT can now be configured for use with the Remote Access Service.

Express Configuration Wizard Installation for Microsoft Windows 3.1 and Windows NT 3.51

The Express Configuration Wizard is a graphical user interface which allows you to configure and test the Express XRT with ease. Follow the installation procedure that applies to the operating system.

1. For Windows 3.1 operating systems, insert the ADTRAN Express Configuration Wizard disk labeled **Windows 3.1** into your 3.5" disk drive. For Windows NT 3.51, insert the disk labeled **Windows 95, Windows NT** into your 3.5" disk drive.
2. In Windows Program Manager, select the **Run...** option under the **File** menu.

3. In the command line, type **a:\setup** (where *a* is the disk drive where the ADTRAN Express Configuration Wizard disk was inserted).
4. Follow the screen prompts and insert disk(s) as requested.

Once installation is complete, an **ADTRAN** program group is created and placed in the Program Manager. The Express Configuration Wizard software can be started by double clicking on the **Express Configuration** icon in the ADTRAN program group. The ADTRAN Express Configuration Wizard software can also be started by double clicking on the **Express Configuration** icon on the Control Panel.

Get On With It!

Go to the section *Using the Express Configuration Wizard* on page 15.

Macintosh Installation

To install the Express Configuration Wizard on a Macintosh, use the following procedure:

1. Insert the floppy disk labeled **Express Configuration Wizard for Macintosh** in the disk drive. The **Express Configuration** floppy icon displays on the desktop.
2. Double-click the **Express Configuration** icon.
3. Double-click the **Express Configuration Installer** icon.
4. The **Express Configuration Wizard** introductory window displays. Click **Continue**.
5. The **Express Configuration Installer** dialog box displays. In the **Install Location** section, select the location to which you want to load the software. The default folder is **Adtran ISDN**.
6. Click **Install**.
7. After installation is complete, select **Quit**.

Basic Telephone Service

In addition to the computer connection, two analog devices such as a telephone, FAX, modem, or answering machine can be connected using the two POTS interfaces on the rear panel (RJ-11 jacks labeled 1 and 2 with a diagram of a telephone above the jack).

Supplementary Voice Services

Supplementary services such as call forwarding, caller ID, call return, call holding, three- or six-way conference, call transfer, call rejection, and call waiting are fully supported by the Express XRT on a touch-tone telephone. These services are available only if included in the ISDN line configuration and are implemented using the standard commands provided by the telephone company.

Call Waiting

Call Waiting permits one voice call to be placed on hold while answering another voice call. Use the flash-hook to place the active call on hold and answer an incoming call. Hanging up terminates both calls. The call waiting tone can be disabled and enabled using a touch-tone phone as follows:

Disable call waiting: Press **** 0**

Enable call waiting: Press **** 1**

Conference Calling

Conference Calling (also known as three-way calling) permits a conversation between three parties, each at different locations.

During a voice call, the call waiting tone signals a second incoming call. Flash-hook to place the first call on hold and answer the incoming call. Flash-hook again to retrieve the first caller. A third flash-hook conferences all three parties.

To enable Call Conferencing, dial ****2** before dialing the telephone number. This enables the Flash Hook button on your telephone to conference up to six people together. The dial code is only necessary when S37=0, when S37=1, or when the Flash Hook button will conference by default.

Automatic Redial

Automatic redial dials the last number dialed. This can be accomplished using a touch-tone phone as follows:

Redial last number: Press ** 5



When connecting to a National ISDN 1 switch, call conferencing, message waiting, and call transferring are assigned a unique feature identifier number. This number may not be the same in all areas. S-registers 90 and 91 contain the feature identifier numbers for conference and transfer. If these features do not work, contact your ISDN provider.

Phone Number Allocation

The Express XRT allocates ISDN phone number 1 to POTS port 1. Connect the primary telephone to POTS port 1 as shown in Figure 2-2 on page 7.

ISDN phone number 2 is shared by the RS-232 port and POTS port 2; therefore, only one can be used at a time.



ISDN data calls and external modem applications must be placed to ISDN phone number 2.

Single Phone Number Operation

For AT&T 5ESS point-to-point lines and other lines with a single phone number, incoming voice calls are routed to POTS port 2 to allow for use of either a modem or a telephone. Service on POTS port 1 is not available.

Using the Express Configuration Wizard

Use one of the following methods to start the Express Configuration program:

For Windows 95 and Windows NT 4.0:

From the **Start** button, choose **Programs**, then **ADTRAN**, then **Express Configuration**.

For Windows 3.x and Windows NT 3.51:

Open **Program Manager**. Double-click the **Adtran** icon and then the **ISDN** icon. Double-click **Express Configuration**.

For the Macintosh operating system:

1. Open the **Adtran ISDN** folder. Double-click the **Express Configuration** icon.
2. The program attempts to auto-detect an Express XRT on COM ports 1-4.



Press Configuration (for Windows 95 and Windows NT 4.0) only auto-detects COM ports 1 through 4. Express Configuration for the Macintosh auto-detects COM ports 1 through 12.

3. If auto-detection is successful, the screen shown in Figure 2-5 displays. Go to step 5.
4. If auto-detection is unsuccessful, the screen shown in Figure 2-4 displays.



Figure 2-4

Unable to Auto-Detect

5. Select **Cancel**. The screen shown in Figure 2-5 on page 16 displays.

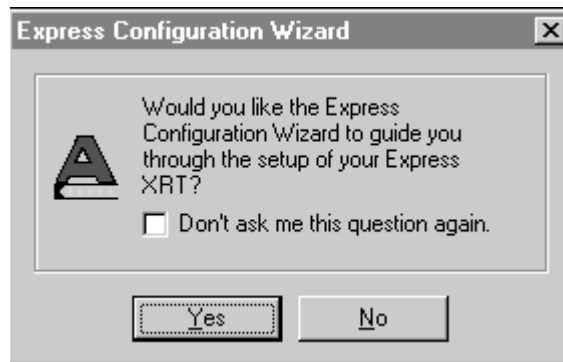

Figure 2-5

Express Configuration Automatic Guide option

6. If you want the Express Configuration Wizard to guide you through the set up process, click **Yes**. The screen shown in Figure 2-6 on page 17 displays. Select **Next**, and the Wizard guides you through the setup process. If you have questions about any of the Wizard screens, click the **Help** button for detailed information.
7. If you want to set up the options yourself, select **No**. The screen shown in Figure 2-7 on page 17 displays. Go to step 8.



*Click the **Don't ask me this question again** box to disable this dialog box for future sessions.*

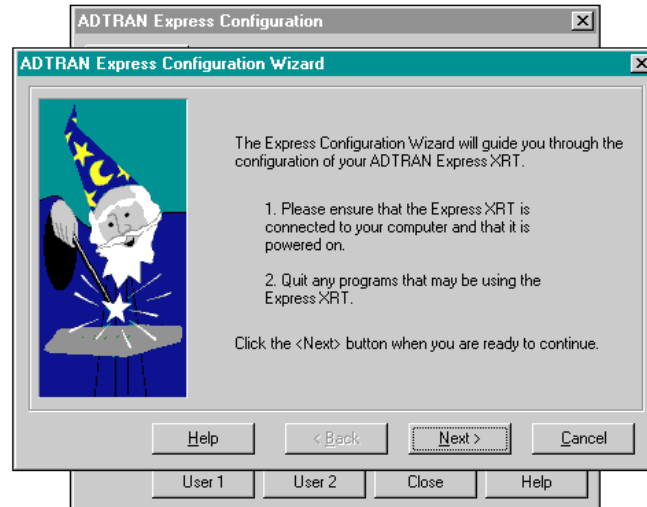

Figure 2-6
Express Wizard Configuration Start Screen

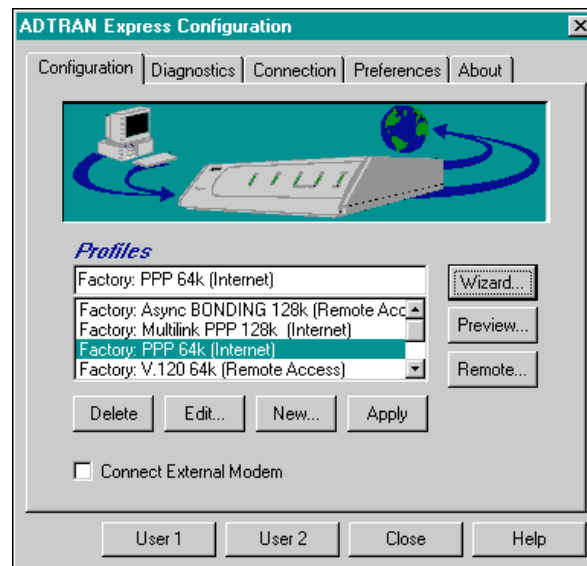

Figure 2-7
Express Wizard Configuration Tab

8. If you did not use the Configuration Wizard to help you with setup, select the **Connection** tab to choose the COM port, baud rate, and ADTRAN model.

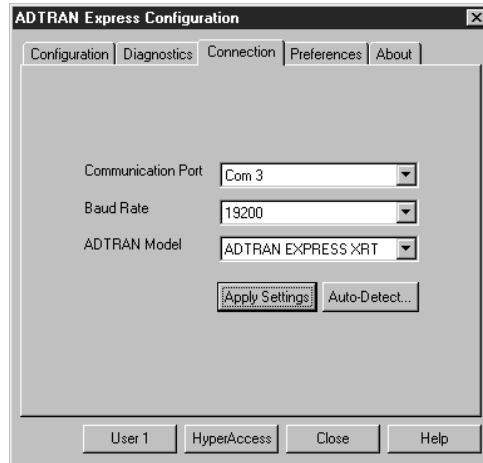

Figure 2-8

Express Configuration Wizard Connection Tab

9. To automatically detect the required information, click the **Auto-Detect** button.

Express Configuration for Windows 95 and Windows NT 4.0 only auto-detects COM ports 1 through 4. Express Configuration for the Macintosh auto-detects COM ports 1 through 12.

NOTE

*To manually enter the settings, select the appropriate options. Select **Apply Settings**.*

After installation is complete, the Express XRT is ready for use. If any error screens are encountered or the unit remains at **Link Down** for longer than 15 minutes, see *Troubleshooting* on page 53.

Auto-Detect SPIDs/Switch Type (Expert ISDN)

NOTE

This option only applies to North American switches.

Auto-detection of SPIDs and Switch Type greatly reduces the likelihood of time-consuming problems occurring during installation of the Express XRT. It evaluates common SPID formats based on the area code and phone numbers and reports success after placing a test call.

After installation is complete, the Express XRT resets the ISDN line for a clean start. Therefore, the PWR/LINE LED may not be on solid (indicating link up) for a few more seconds.

In the few cases where the procedure does not succeed, the non-standard SPIDs may be entered at Step 9 of the preceding procedure (*Using the Express Configuration Wizard* on page 15).

Using the Express Configuration Wizard Help

On-line help is available by clicking the **Help** button displayed in the Configuration screen. On-line help provides detailed information regarding such features as creating a custom profile, defining a user button, remote configuration, and testing.

Express Configuration Wizard Tray Tool

The Tray Tool is used for quick access to the Express Configuration Wizard and to enable or disable the external analog modem when used with an Express XRT.



The Express Configuration Wizard Tray Tool is provided only with the Windows 95 and Windows NT 4.0 versions of the Express Configuration Wizard.

To enable the Express Configuration Wizard Tray Tool, use the following procedure:

1. Run the Express Configuration Wizard. See the section *Using the Express Configuration Wizard* on page 15.
2. Close the Express Configuration Wizard.
3. Once the Express Configuration Wizard is closed, the Windows 95 or Windows NT 4.0 taskbar will have a new icon in the Tray Tool. Figure 2-9 on page 20 illustrates the new taskbar with the new icon in the Tray Tool.



Figure 2-9

Express Configuration Wizard Tray Tool

To prevent the Express Configuration Wizard Tray Tool from launching once the Express Configuration Wizard software is closed, uncheck the box labeled **Add Tray Icon** under the **Preferences** tab in the Express Configuration Wizard software (shown in Figure 2-10).

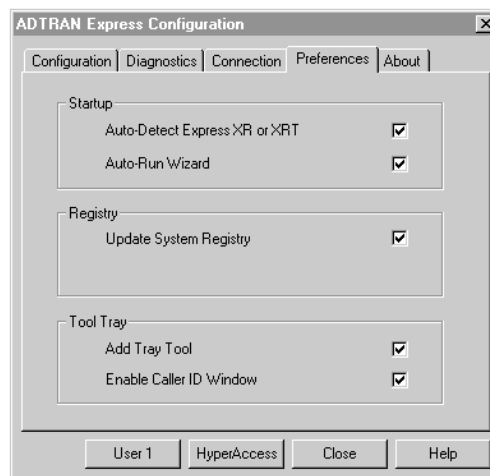

Figure 2-10

Preferences Tab

Three icons appear in the Tool Tray at different times representing three different states of the Express Configuration Wizard Tray Tool.

The icon illustrated in Figure 2-11 indicates the external analog modem is connected to the Express XRT and is enabled. Double clicking on this icon causes the Express Configuration Wizard Tray Tool to disable the external analog modem.



Figure 2-11

Express XRT Disabled, External Analog Modem Enabled

The icon illustrated in Figure 2-12 indicates the external analog modem is not connected and/or not enabled.

Double clicking on this icon enables the external modem when connected to an Express XRT.



Figure 2-12

Express XRT Enabled, External Analog Modem Disabled

The icon illustrated in Figure 2-13 indicates that the Express Configuration Wizard Tray Tool is in an unknown state. This icon may appear if the Express XRT is not connected to a COM port on the PC. Double clicking on this icon instructs the Express Configuration Tray Tool to refresh the connection status.



Figure 2-13

Unknown State

Express Configuration Tray Tool Menu

When using the Express Configuration Wizard Tray Tool with the Express XRT, use the **right** mouse button and click on the icon. The menu in Figure 2-14 appears.



Figure 2-14

Express Configuration Wizard Tray Tool Menu

If the Express Configuration Wizard Tray Tool is used with an Express XR, a slightly different menu appears.

Enable/Disable Modem

This option enables or disables the external analog modem. This option is only available when connected to an Express XRT. See the chapter *Installing an Analog Modem* on page 27 for more information.

Properties

Launches the Express Configuration Wizard software.

Refresh

Instructs the Express Configuration Wizard Tray Tool to refresh the icon status.

About

Displays version information.

Exit

Exits the Tray Tool.

Installing Windows 95 Dial-Up Networking

Dial-Up Networking for Windows 95 is most commonly used for connections to Internet Service Providers or other networks.

Use the following procedure to install Windows 95 Dial-Up Networking:

1. From **Start**, choose **Settings**, then **Control Panel**, then double click **Add/Remove Programs**.
2. Double click on the **Communications** option under the **Windows Setup** tab.
3. If not already selected, check **Dial-Up Networking**.
4. Click **OK** to select these changes.
5. Click **OK** to begin installation of **Dial-Up Networking**.
6. Restart the computer.
7. Once Windows boots, from **Start**, choose **Settings**, then **Control Panel**, then double click **Network**.
8. From the **Network** list, verify the following components are installed: Dial-Up Adapter and TCP/IP for Dial-Up Adapter. If you intend to use your Express XRT for Internet access, these should be the only components needed. Verify the software setup from your Internet Service Provider or network administrator to ensure that the networking components are set up properly.
9. Click **OK** once you have verified that these components are installed.
10. To create a Dial-Up Networking connection select **My Computer**, then choose **Dial-Up Networking**. The first time Dial-Up Networking has been used, the **Welcome to Dial-Up Networking** menu appears.
11. Click **NEXT**.
12. Enter the name for this connection and select the **ADTRAN Express XRT** from the modem list. You may configure DTE speed and server information by choosing the **Configure** button next to the selected modem.
13. Click **NEXT**.

14. In the **Make a New Connection** menu, enter the number to dial.
15. Click **NEXT**.
16. Click **Finish** to complete the new connection setup.
17. To use this connection, select it from **My Computer, Dial-Up Networking**. Windows dials the number using the modem and properties as configured. When using the connection the first time, network log in information such as the user name and password must be entered. This information should be provided from the Internet Service Provider.

VT 100 TERMINAL EMULATION

The Express XRT can be configured using any communications package supporting VT 100 terminal emulation. To enter into the menus, type **AT!V Enter**. To go to a particular menu, press the hot key sequence for that menu. The main branches of the menu tree and their hot keys are as follows:

STATUS	(Ctrl + V)
TEST	(Ctrl + T)
CONFIG	(Ctrl + C)
DIAL	(Ctrl + D)



NOTE

Ensure that the communications package is configured to pass these Control Sequences through to the Express XRT.

To exit the menus, press **Ctrl + X**. The **Ctrl + X** command also places the unit back on-line if a call is connected.

Some features in the Express XRT do not immediately take effect upon selection. This prevents unintentional reconfiguration of the Express XRT during an active call. Items such as **Protocol** and **Call Type** take effect *only* at the beginning of a new call.

VT 100 Configuration

1. After connecting a VT 100 terminal enter the command **AT!V** followed by **Enter**. The Configuration screen is the first screen displayed. An illustration of this screen is shown in Figure 2-15 on page 25.
2. Enter the area code.
3. Enter ISDN phone number 1.

4. Enter ISDN phone number 2.
5. Enable Auto-Detect SPIDs/Switch (this option is only valid in North America).
6. View the status by using the key sequence **Ctrl+V**. An illustration of the status screen is shown in Figure 2-16 on page 26.

```

Express XRT Configuration Menu
1) Area Code = 205                17) Configure Remote Unit
2) ISDN Phone Number 1 =         18) Remote Num. Password =
3) ISDN Phone Number 2 =
4) Auto-Detect SPIDs/Switch = Disabled
5) Switch Type = National ISDN1
6) Call Type = Data 64K
7) SPID 1 =
8) SPID 2 =
9) Auto Answer = Disabled
10) Call Screening = Answer Any
11) Call Routing = All Types->DTE
12) DTR Options = Ignore DTR
13) Flow Control = Hardware Flow
14) Protocol = PPP Asyn-Sync
15) PPP Mode = PPP
16) Profiles

Select =                          Enter SELECT   Esc NO CHANGE

Ctl-V STATUS  Ctl-T TEST  Ctl-C CONFIG  Ctl-D DIAL  Ctl-X EXIT

```

Figure 2-15*VT 100 Terminal Configuration Menu*

VT 100 Terminal Status Buffer

The status buffer can be displayed at any time after entering the menu structure. Pressing **Ctrl + V** displays the Express XRT Status menu. The last 20 status messages generated during the operation of the unit are displayed with relevant status items. See Figure 2-16 on page 26. Status messages provide information about call progress, ISDN link status and error conditions. The most recent status message appears as Status 1, with the remaining status messages appearing in descending order. The status buffer messages and their descriptions are listed in the appendix *Status Buffer Messages* on page 73.

Press **Ctrl + C** to return to the Configuration menu.

```
Express XRT Status Menu
UNIT/LOOP STATUS          STATUS BUFFER
Call Type                 = Data 64K          1 = Factory Reset 0
DTE Rate                  = 9600             2 = EMPTY
Self Test                 = Passed           3 = EMPTY
Software Rev              = X.27            4 = EMPTY
Checksum                  = c23c           5 = EMPTY
Serial Number             =                 6 = EMPTY
Loop Status               = Link Down       7 = EMPTY
Num Dialed                = No Call        8 = EMPTY
RTS                       = On             9 = EMPTY
CTS                       = On            10 = EMPTY
DCD                       = Off           11 = EMPTY
DTR                       = On           12 = EMPTY
                          13 = EMPTY
                          14 = EMPTY
                          15 = EMPTY
                          16 = EMPTY
                          17 = EMPTY
                          18 = EMPTY
                          19 = EMPTY
                          20 = EMPTY_
-----
Ctl-U STATUS  Ctl-T TEST  Ctl-C CONFIG  Ctl-D DIAL  Ctl-X EXIT
```

Figure 2-16
VT 100 Terminal Status Buffer Menu

Chapter 3

Installing an Analog Modem

An external or internal analog modem can be connected to the Express XRT to access an Internet provider, BBS, or host server that does not support ISDN.

EXTERNAL ANALOG MODEM APPLICATION

In order to connect an external analog modem to the Express XRT, the following items are necessary:

- External analog modem
- RS-232 serial cable
- RJ-11 to RJ-11 telephone cable



Incoming calls must use ISDN phone number 2 for external analog applications.

In addition to the RS-232 cable connecting the Express XRT to the PC, a separate RS-232 cable is required to connect an external analog modem to the Express XRT. This RS-232 cable is not supplied.

Figure 3-1 on page 28 illustrates an external analog modem connected to the Express XRT. This setup requires only one PC COM port, and supports DTE rates of up to 115.2 kbps.

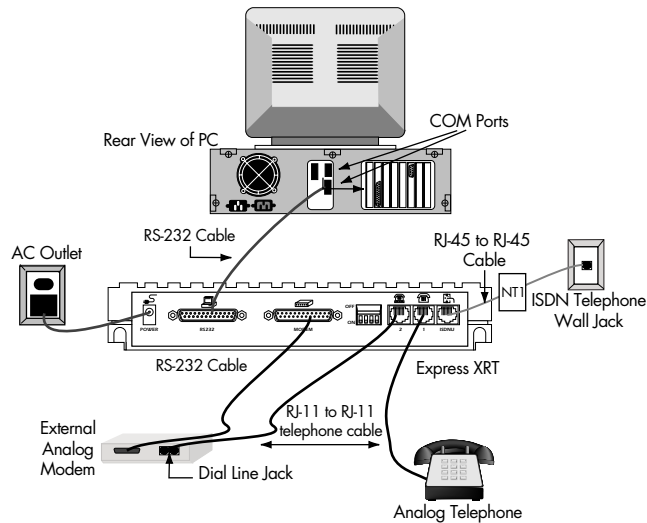

Figure 3-1

External Analog Modem Application

Connecting an External Analog Modem

To connect an external analog modem to the Express XRT use the following procedure:

1. Ensure the Express XRT is connected to the PC. See the section *Connecting the Express XRT* on page 6 for detailed instructions.
2. Ensure the modem power is OFF before connecting it to the Express XRT.
3. Connect one end of the RS-232 serial cable to the external analog modem.
4. Connect the other end of the same RS-232 serial cable to the Express XRT port labeled **MODEM**. An illustration of a modem is positioned above the modem port.
5. Connect one end of the RJ-11 to RJ-11 telephone cable to the telephone jack labeled **2** on the Express XRT. Positioned above the jack is an illustration of a telephone above a modem.

6. Connect the other end of the RJ-11 to RJ-11 telephone cable to the **Dial Line** or **Line** jack on the external analog modem. See the documentation with the external analog modem to determine which jack on the external analog modem is the **Dial Line** or **Line** jack.
7. Power ON the external analog modem.

The external analog modem is now connected to the Express XRT. In order to configure the external analog modem for use, set up the communications software to use the same serial COM port to which the Express XRT is connected.

If you are connecting a modem to the Express XRT that has already been in use by Windows 95, you are ready to use the external analog modem. The external analog modem can be enabled either through the Express Configuration Wizard or by using a VT 100 terminal emulation package. See the section *Express Configuration Tray Tool Menu* on page 22 for more information on enabling and disabling an analog modem.

If you are connecting an external analog modem that has not been previously in use by Windows 95, see the section *Installing a New External Analog Modem* on page 29.

Installing a New External Analog Modem

1. Start the Express Configuration Wizard.
2. Click **Connect External Modem**.
3. Click **Close**.
4. From **Start**, select **Setting**, then **Control Panel**, and double click **Modems**.
5. Click **Add**.
6. Select **Don't detect my modem; I will select it from a list**.
7. Click **NEXT**.
8. Select the manufacturer and model of your modem. If your modem is not listed, or if you have an installation disk, click **Have Disk**.
9. Click **NEXT**.
10. Select the COM port to use with this modem. This will be the same COM port that is used by the Express XRT.
11. Click **NEXT**.

12. Click **FINISH**.
13. Click **Close**.
14. The external analog modem may now be used, or you may restart the Express Configuration Wizard and deselect the **Connect External Modem** option to enable the Express XRT.

Configuring an External Analog Modem

If the modem does not support 230.4 kbps, dip switch 1 on the back panel of the Express XRT must be On (down) to install and use an external modem with the Express XRT. This limits the DTE speed to 115.2 kbps when using the Express XRT with an external modem. To re-enable the 230.4 kbps operation for ISDN connections, set dip switch 1 to the Off (up) position.

When using applications supporting Express XRT operation at 230.4 kbps with an external analog modem that does not support 230.4 kbps, attach the Express XRT to the high speed 16650 UART COM port and connect the external modem to a separate COM port. This allows the Express XRT to operate at 230.4 kbps and the external modem to operate at the reduced speed.

Required External Analog Modem Settings

There is one setting in the external modem that is required before trying to enable the modem with the Express Configuration Wizard. The Carrier Detect signal from the modem should be set to **Normal** (track the CD signal). This can be accomplished by using the AT command **AT&C1**. AT commands can be entered into the modem using the following procedure:

<cr> indicates to press the **Enter** key on the keyboard.

1. Open a terminal emulation session using HyperACCESS or HyperTerminal.
2. Type **AT_L1 <cr>**
3. Type **AT <cr>**
4. Type **ATI <cr>**
5. Type **AT &C1 <cr>**
6. Type **AT&W <cr>**
7. Type **AT_L0 <cr>**

Controlling an External Analog Modem

There are three options for enabling and disabling an external modem: the Express Configuration Wizard, the WIN 95/NT 4.0 Tool Tray Icon, or a terminal emulation package. See the section *Express Configuration Tray Tool Menu* on page 22 for more information on enabling and disabling a modem.

Once the external analog modem is enabled, all further COM activity is transmitted to the external analog modem connected to the Express XRT modem port. The external analog modem RTS and CTS lines are switched over to the PC COM port directly when the Express XRT is commanded to enable the external modem port. This allows the external analog modem to provide flow control as normal.

When the external analog modem is disabled, all further COM port activity is processed by the ISDN terminal adapter within the Express XRT.

Express Configuration Wizard Modem Enable

Run the Express Configuration Wizard and select the **Connect External Modem** option under the **Configuration** tab. Figure 3-2 on page 32 illustrates the Express Configuration Wizard **Connect External Modem** option.

See the section *Express Configuration Wizard Tray Tool* on page 19 for more information on enabling a modem.

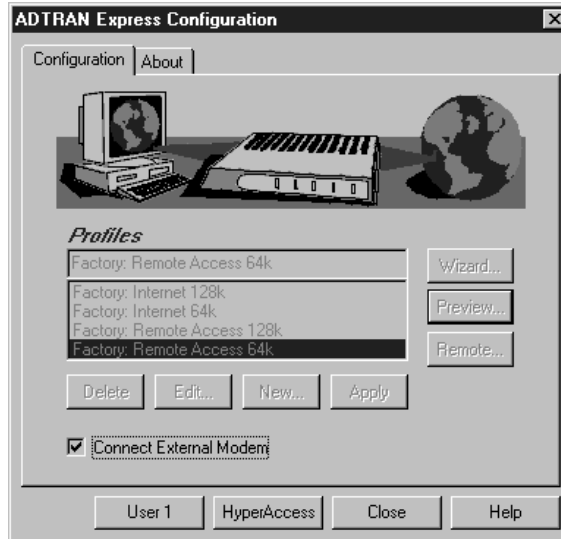

Figure 3-2

Express Configuration Wizard: Connecting an External Modem

If the Express Configuration Wizard software cannot detect the external analog modem, the error message shown in Figure 3-3 displays. Ensure the external analog modem and the Express XRT are powered on and the external analog modem is properly connected to the Express XRT.



Figure 3-3

No Modem Attached Error Message

Express Configuration Wizard Modem Disable

Use the Express Configuration Wizard to disable the external analog modem by deselecting the **Connect External Modem** option. Figure 3-2 on page 32 illustrates the **Connect External Modem** option.

See the section *Express Configuration Tray Tool Menu* on page 22 for more information on disabling a modem.

Terminal Emulation Modem Enable

An alternative method of enabling/disabling an external analog modem is to use a terminal emulation package such as HyperACCESS. In order to determine if an external analog modem is properly connected to the Express XRT, issue the AT command **AT!Z** (followed by **Enter**). If an external analog modem is properly connected to the Express XRT, the Express XRT responds with the message **MODEM FOUND** (shown in Figure 3-4 on page 34).

The **AT!Z** command is directed to the Express XRT, not the analog modem itself. An **ERROR** occurs if the command is sent while the external analog modem is enabled.

If the external analog modem is not properly connected to the Express XRT, the Express XRT responds with the message **NO MODEM FOUND**.

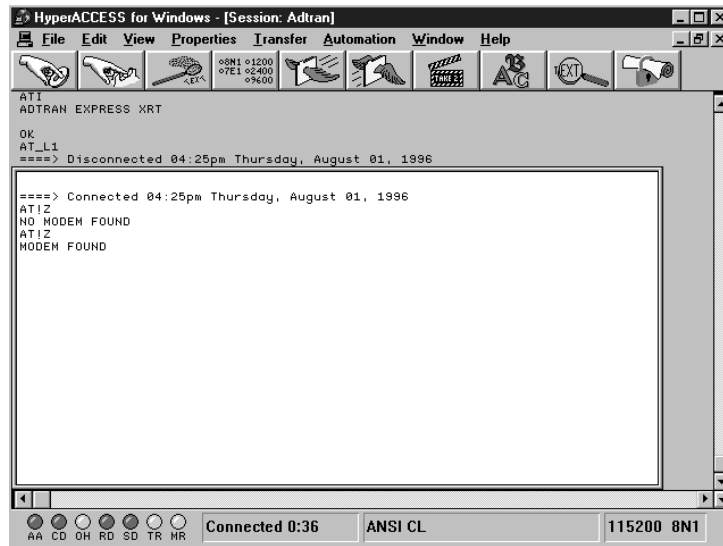

Figure 3-4

HyperACCESS: Verifying External Modem Connection

To enable an external analog modem, issue the AT command **AT_L1** (followed by **Enter**). Figure 3-5 illustrates a HyperACCESS session enabling an external analog modem.

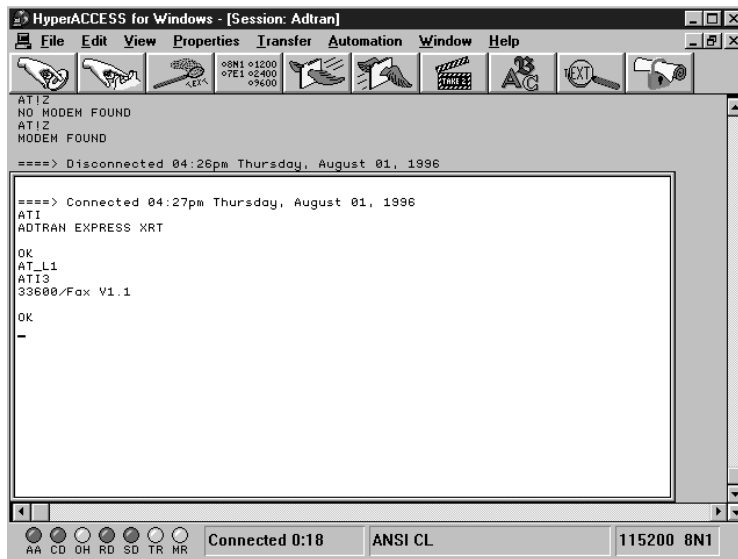

Figure 3-5

HyperACCESS: Enabling an External Analog Modem

Terminal Emulation Modem Disable

When using HyperACCESS or other terminal emulation packages, issue the AT command **AT_L0** (followed by **Enter**). Figure 3-6 illustrates a HyperACCESS session disabling an external analog modem.

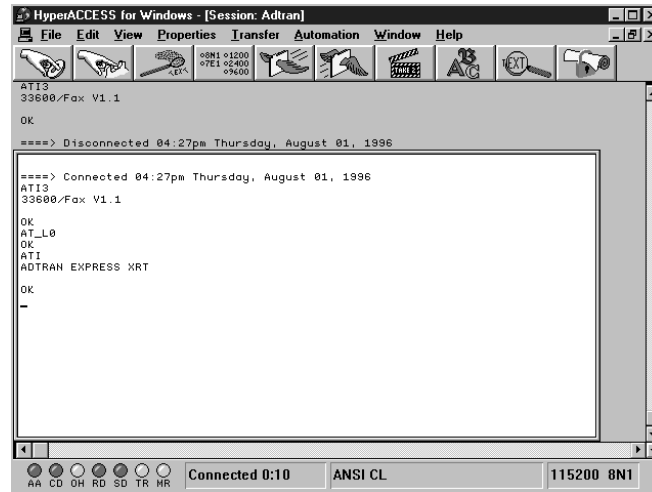

Figure 3-6

HyperACCESS: Disabling an External Analog Modem

If carrier detect (CD) is active (a call is connected) on the external analog modem when attempting to disable it, the Express XRT will not switch control from the modem port. The call must be hung-up (disconnected) to deactivate CD.

INTERNAL ANALOG MODEM APPLICATION

In order to connect an internal analog modem to the Express XRT, the following items are necessary:

- Internal analog modem
- RJ-11 to RJ-11 telephone cable

Figure 3-7 on page 36 shows how to connect an internal modem to the Express XRT.

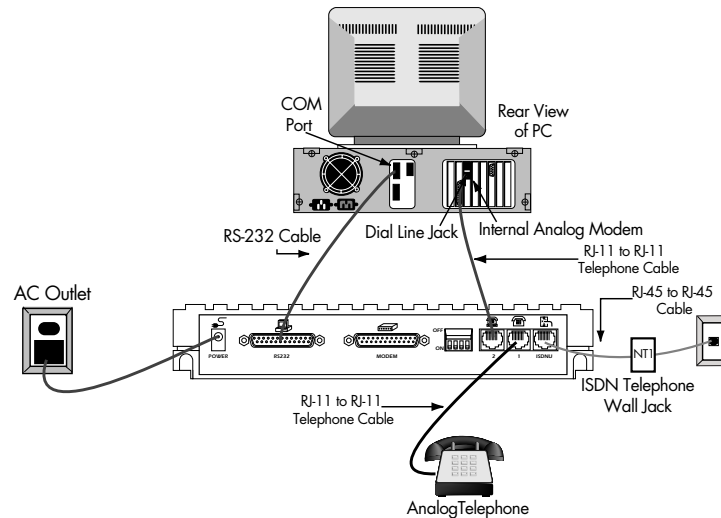

Figure 3-7

Internal Analog Modem Application

When using an internal analog modem and the Express XRT, two COM ports are assigned on the PC. Both COM ports are configured independently. See the manufacturer's documentation for internal analog modem configuration.

Connecting an Internal Analog Modem

To connect an internal analog modem to the Express XRT, use the following procedure:

1. Ensure the Express XRT is connected to the PC. See the section *Connecting the Express XRT* on page 6 for detailed instructions.
2. Connect one end of the RJ-11 to RJ-11 telephone cable to the telephone jack labeled **2** on the Express XRT. Positioned above the jack is an illustration of a telephone above a modem.
3. Connect the other end of the RJ-11 to RJ-11 telephone cable to the **Dial Line** or **Line jack** on the internal analog modem. See the documentation for the internal analog modem to determine which jack on the internal analog modem is the **Dial Line** or **Line** jack.

Chapter 4

Application Configuration

There are three methods available for configuring the Express XRT: Express Configuration Wizard, VT 100 terminal, or AT Commands.

Before configuring the Express XRT for any application, the Express XRT should be connected correctly for the application as described in the chapter *Installation* on page 5.

Some features in the Express XRT do not take effect upon selection. This prevents unintentional reconfiguration of the Express XRT during an active call. Items such as Bit Rate, Protocol, and Call Type take effect only at the beginning of a new call.

Technical notes, documents and scripts can be found on the ADTRAN web home page at <http://www.adtran.com> under the **Information Desk**. These provide information on how to use ADTRAN products in specific applications on PC and Macintosh platforms.

FACTORY DEFAULT CONFIGURATION

The Express XRT is shipped configured as follows:

Auto-Detect SPIDs/Switch	Disabled
Switch Type	Euro ISDN
Call Type	Data 64K
Auto Answer	Enabled
Call Screening	Answer Any
Call Routing	Speech/Audio calls to POTS

DTR Options	Ignore DTR
Flow Control	Hardware Flow
Protocol	Fallback

The Express XRT can be reset to the factory default settings by setting switch 2 to the Off (up) position. See the section *Verify Switch Settings* on page 5 for more information.

Profile Configurations

Some common configurations are preset in the Express XRT software as profiles. Most Internet service providers supporting ISDN also support PPP protocol. If connecting to an Internet service provider using one B-channel, select **Factory: PPP 64k (Internet)**, which sets the protocol to PPP. If arrangements have been made with the Internet service provider to use two B-channels, select **Factory: Multilink PPP 128k (Internet)**, which uses multilink PPP protocol.

Loading a factory profile has no effect on any ISDN Phone Number(s) or Switch Type settings already configured. The settings that are altered when applying a profile are shown as follows:

Factory: PPP 64k (Internet)

Call Type	Data 64kbps
Auto Answer	Enabled
DTR Options	Ignore DTR
Flow Control	Hardware
Protocol Type	PPP
PPP Mode	Single-link PPP

Factory: Multilink PPP 128k (Internet)

Call Type	Data 64kbps
Auto Answer	Enabled
DTR Options	Ignore DTR
Flow Control	Hardware
Protocol Type	PPP
PPP Mode	Multilink PPP

Factory: V.120 64k (Remote Access)

Call Type	Data 64kbps
Auto Answer	Enabled
DTR Option	Ignore DTR
Flow Control	Hardware
Protocol Type	CCITT V.120

Factory: Async BONDING 128k (Remote Access)

Call Type	Data 64kbps
Auto Answer	Enabled
DTR Options	Ignore DTR
Flow Control	Hardware
Protocol Type	Async BONDING

Express Configuration Wizard

This section describes how to use the Express Configuration Wizard software to configure the Express XRT for three common applications: Internet access, remote access, and bulletin board service (BBS) access.

The Express Configuration Wizard software and the application software such as Chameleon™ for Internet™ access or ShivaRemote for remote access should be installed on the computer.

The following procedures have been written for Windows 3.1 operating systems. Other operating systems may vary.



Some features are not available in all versions of the Express Configuration Wizard.

Starting the Express Configuration Wizard Software

After installing the Express Configuration Wizard Software, use the following procedure to launch the software:

1. In the Windows Program Manager, open ADTRAN program group.
2. Double click on the icon labeled **Express Configuration**. The ADTRAN Express Configuration Wizard window is displayed.

Internet and Remote Access

Chameleon by NetManage is a Microsoft Windows software package commonly used for Internet access.

ShivaRemote is a software package developed by Shiva Corporation for remote access.

Use the following procedure to configure the Express XRT for Internet access using Chameleon or remote access using ShivaRemote.

Creating a Custom Profile

1. In the ADTRAN Express Configuration window, create a **New** profile by choosing the **New** button and continuing through the steps in this procedure, or choose the **Wizard** button and let the Express Configuration Wizard guide you through the setup (skip the rest of this procedure).
2. Select an existing profile on which to base a new profile. To view the settings for a profile, click on the name of the profile and choose the **Preview** button.
3. The **ISDN Line Setup** tab displays (shown in on page 41). Select the text in the **Name of Profile** box and enter a new name for the profile. For example: **Joe's Internet Connection**.

Figure 4-1
ISDN Setup Tab

4. Enter the following information (under the **ISDN Line Setup** tab) as provided by your telephone company:

- Switch Type
- Area Code
- ISDN Phone Number(s)
- Service Profile Identification Number(s) (does not apply to units outside of North America)



*If the unit is being configured in North American and service profile identifiers (SPIDs) and switch type are unknown, check the box labeled **Auto-detect SPIDs/Switch** and they are determined automatically once the **OK** button is selected.*

5. After completing the parameters in the **ISDN Line Setup** window, click on the **Protocol** tab (shown in on page 42).

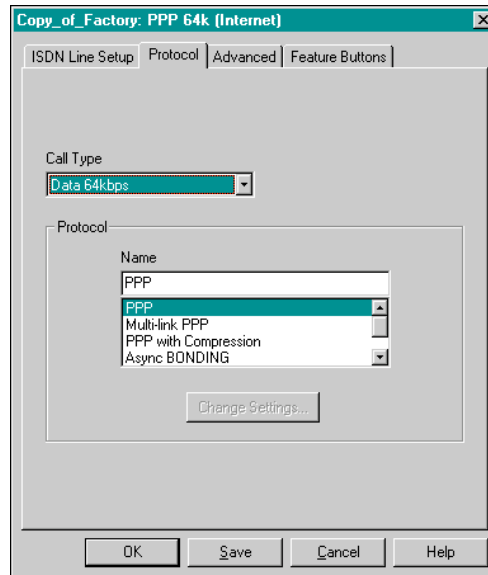

Figure 4-2
Protocol Tab

6. The Call Type should only be changed to **Data 56 kbps** if **Data 64 kbps** is not available in your area.
7. Select **PPP** protocol if configuring for Internet access using Chameleon (or other Internet access package), or select **Async BONDING** protocol if configuring for remote access using ShivaRemote.
8. Choose the **OK** button. The new profile now appears alphabetically in the profiles list of the ADTRAN Express Configuration Wizard window.

Defining a User Program Button

A button can be added to the ADTRAN Express Configuration Wizard window to automatically launch an application like Chameleon, ShivaRemote, or other data communications packages.

ADTRAN has developed a variety of technical support notes and modem scripts for popular data communication packages such as Procomm Plus®, pcANYWHERE™, ReachOut® and more. These can be found on the ADTRAN home page (<http://www.adtran.com>) under the ISDN Information Desk.

The following procedure explains how to create a button for the profile created in the previous procedure:

1. Select the profile from the profile list in the ADTRAN Express Configuration Wizard window.
2. Choose the **Edit** button.
3. Choose the **Advanced** tab (shown in Figure 4-3).

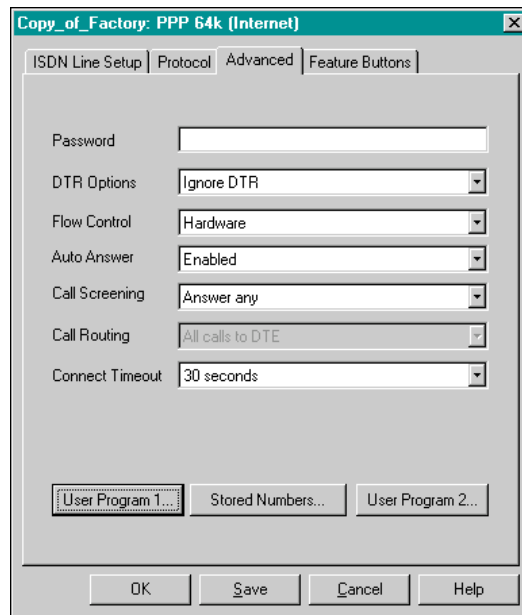

Figure 4-3
Advanced Tab

4. Choose either the **User Program 1...** or **User Program 2...** button.
5. Choose the **Change Program...** button.
6. Use the Drives and Directories fields to navigate to the executable file. The executable file for Chameleon is **custom.exe** and the default location is **c:\netmanag\custom**. The executable file for ShivaRemote is **connectw.exe** and the default location is **c:\shiva\connectw.exe**.
7. Once the executable file has been selected, choose the **OK** button in the **Open** window.

8. The User Program window is displayed again and the name field can be changed to give the button being created a different name. If no name is entered, a button is created with a default name of the executable file.
9. Choose the **OK** button to update the profile settings.

The **User Program** button previously selected is updated in the ADTRAN Express Configuration Wizard window to reflect the new profile name. To launch the application, choose this button and follow the application documentation for complete setup information.

Inactivity Timer

Set the inactivity timer to equal the number of minutes (from 1 to 255) for the DTE to be idle before the Express XRT automatically hangs up the current call. Entering 0 in this field disables the inactivity timer.

Calling Features Options

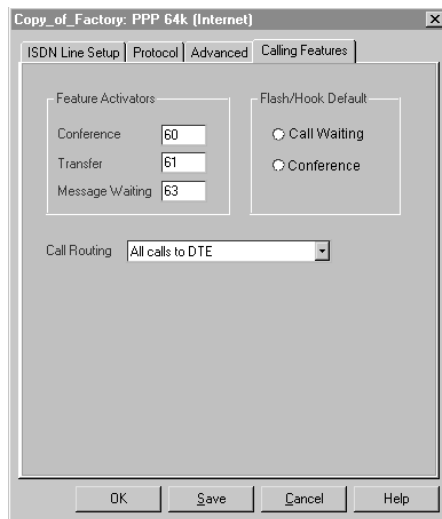

Figure 4-4

Calling Features Tab

Message Waiting Indicator

If your ISDN line is provisioned with a message waiting indicator, a stuttered dial tone will be present on the POTS port when a message is unread. The stuttered dial tone is only present on the

directory number on which message waiting has been provisioned. Once a message is read, the stuttered dial tone will stop.

Flash/Hook Default

When you select the Call Waiting option, the phone will function like a standard phone with call waiting. When you select Conference, the flash hook will connect up to six people via a conference call. See *Call Waiting* on page 13 and *Conference Calling* on page 13 for details.

Incoming Voice Call Options

These options specify how the Express XRT is to route incoming voice calls.

Call Routing**All Calls to DTE**

Routes all calls to the RS-232 port, regardless of Call Type.

Speech calls to POTS

Routes calls with a Speech Call Type to the POTS ports. Calls with Data 56k, Data 64k, and Audio are routed to the RS-232 port.

Speech/Audio calls to POTS

Routes calls with Speech and Audio Call Types to the POTS ports. Calls with Data 56k and Data 64k are routed with the RS-232 port.

Enable Call Rejection List

Enabling this option configures the Express XRT to compare all incoming Speech and Audio calling party numbers to the list of ten numbers in the Incoming Voice Call Rejection List. If a match between the incoming calling party number and an entry in the Incoming Voice Call Rejection List is found, the Express XRT will not ring the POTS port. Generally the caller will experience a busy signal. A message in the Status Buffer is the only indication that a call has been rejected.

Enable Anonymous Call Rejection

This option enables rejection of calls where the calling party number is blocked. These numbers normally appear as Private on a Caller ID unit. When an incoming anonymous call is received, while Anonymous Call Rejection is enabled, the call will not ring the POTS ports. Generally the user will experience a busy signal. A message in the Status Buffer is the only indication that an anonymous call has been rejected.

BBS Applications

To access a bulletin board service, a new profile will need to be created and the protocol of the bulletin board service must be known. HyperACCESS is a Microsoft Windows communications package for use in accessing bulletin board services. To define a custom HyperACCESS session, use the following procedure.

Defining a Custom HyperACCESS Session

The following procedure explains how to create a custom HyperACCESS session that can be launched using an icon in the HyperACCESS Phonebook menu.

1. Choose the **HyperAccess** button in the ADTRAN Express Configuration Wizard window. The Phonebook window is displayed.
2. Press the **New** button in the Phonebook window. The Description window displays.
3. Type in a name for the session in the **System Name** box.
4. Choose an icon for the session in the Icon box.
5. Choose the **OK** button.
6. Verify and enter the following settings:
 - Phone Number to Dial
 - Baud Rate
 - COM Port
 - Modem
7. Choose the **OK** button.
8. Choose the **Establish a Connection** button on the tool bar (the first button on the left). Once connection is established, **Connected** is displayed at the bottom of the Session window.
9. When the session is complete, disconnect the call by choosing the **Break a Connection** button on the tool bar (second button from the left). **Disconnected** is displayed at the bottom of the Session window.
10. Save the file by selecting **Save** in the File menu.
11. Select **Close** in the File menu.

This custom session can now be used by double-clicking on the new icon just created.

Shiva Password Authentication Protocol (SPAP)

The Express XRT now supports Shiva Corporation's SPAP. The Express XRT decodes the SPAP packets as they pass between the client and server PPP devices. SPAP user authentication request packets seen on the first link are replayed on the second link. The Express XRT supports the following SPAP features:

- authentication packets
- dialog packets (for third party authentication)
- alert packets
- virtual connections

Chapter 5

Upgrading Software

As features are added to the Express XRT, software upgrades may be necessary. The Express XRT has flash memory allowing the software to be upgraded from a file provided by ADTRAN. The current version of the software can be found on the **About** tab in the Express Configuration Wizard or on the Status menu in the VT 100 Terminal Emulation menus.

The software can be upgraded using the Express Configuration Wizard, HyperACCESS, or any terminal emulation package supporting the XMODEM or XMODEM 1K protocols. Proceed to the appropriate section for further instruction.



If a terminal emulation package other than HyperACCESS is selected, see the instructions supplied with the package to set up an XMODEM or XMODEM 1K connection.

EXPRESS CONFIGURATION WIZARD

1. Start the Express Configuration Wizard. See the section titled *Using the Express Configuration Wizard* on page 15 for detailed instructions.
2. Click the tab labeled **Diagnostics**.

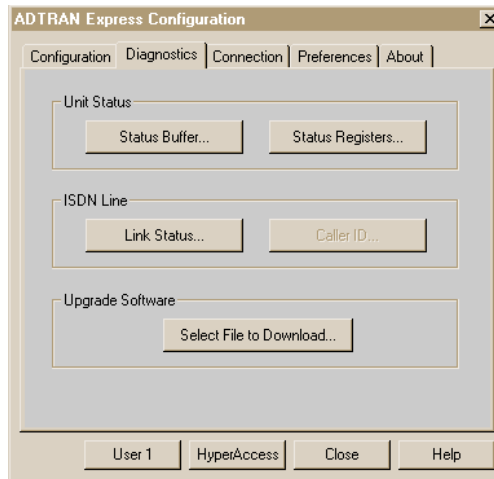

Figure 5-1
Diagnostics Tab

3. Click the button labeled **Select File to Download**. Select the file to download to the Express XRT, and click **Open**.
4. To start the software upgrade, click the **Start Download** button.



*During the software upgrade, the **PWR/LINE** LED will no longer be illuminated. Only the **TD** LED will flash during the software upgrade process. Once the process is complete, the Express XRT will reset.*

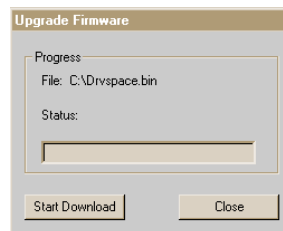

Figure 5-2
Upgrade Firmware Dialog Box

5. When the software upgrade is complete, a message displays indicating the status of the software upgrade. See *Troubleshooting* on page 53 if the software upgrade failed.
6. Close the Express Configuration Wizard when complete.

HyperACCESS

For Windows 95 and Windows NT 4.0:

From the **Start** button, choose **Programs**, then **HyperACCESS for Windows**.

For Windows 3.1 and Windows NT 3.51:

1. Open the Program Manager. Double-click the **HyperACCESS for Windows** program group and then the **HyperACCESS for Windows** icon.
2. Press the **New** button in the Phonebook window.
3. Type in a name for the session in the **System Name** box.
4. Choose an icon for the session.
5. Click the **OK** button.
6. On the session Communications screen, do not enter a **Phone number**. For the **Port name**, select the COM port to which the Express XRT is connected.
7. Enter the following for the remainder of the settings:

Settings:	auto-detect
Terminal emulator:	VT 100
Baud rate:	57600
Priority:	Normal
Port type:	Standard Com Port
Modem:	Direct Connect (Cabled)

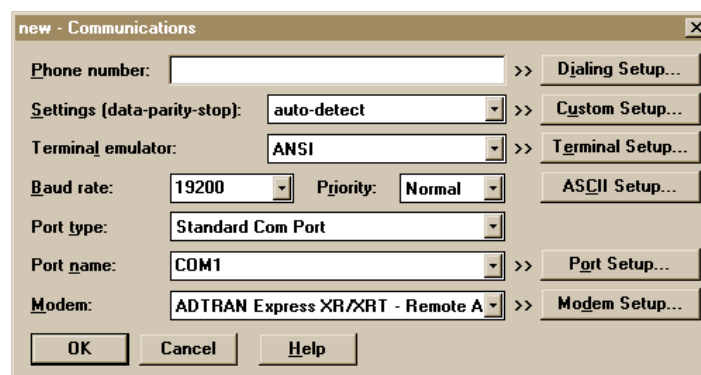

Figure 5-3

HyperACCESS Communications Dialog Box

8. Click **OK** once all the settings are entered.
9. Click on the **Establish a Connection** button on the tool bar (the

- first button on the left). Once a connection is established, **Connected** displays at the bottom of the Session window.
10. Type **AT!FLASHLOAD** to initiate the software update. The AT command will not be visible since echo is off by default. To enable echo, type **ATE1**.
 11. Press the **Y** key on the keyboard when prompted if you are ready to proceed with the software upgrade.
 12. Click on the **Transfer** menu and then click **Send**.

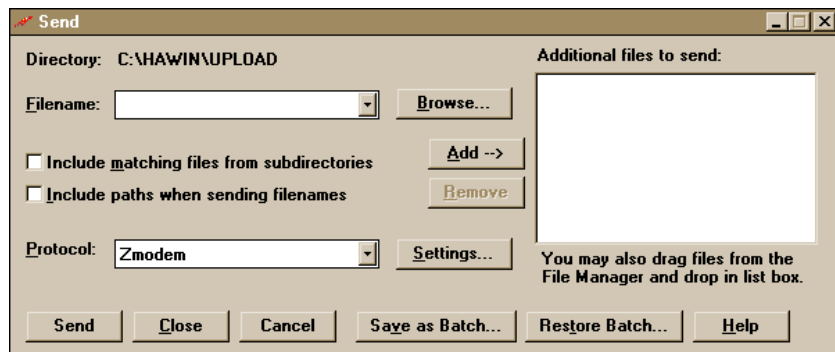

Figure 5-4
Send Dialog Box

13. Click **Browse** to locate the software upgrade file.
14. Select **1K Xmodem** for the **Protocol**.
15. Click **Send**.
16. Once the download is complete, exit HyperACCESS, saving the session if desired.

The software update is now complete. If the **PWR/LINE**, **B1**, and **B2** LEDs are flashing, the software update failed. See *Troubleshooting* on page 53 if the software upgrade failed.

Chapter 6

Troubleshooting

TROUBLESHOOTING GUIDELINES

This section provides troubleshooting techniques to alleviate problems that may be encountered while operating the Express XRT. If problems persist contact ADTRAN technical support for assistance (see the back cover of this manual).

Power/Line LED is Off

This indicates a problem with the power to the unit. Verify that the power cord is connected to the Express XRT and is plugged into a known working electrical outlet. If the Euro ISDN switch is selected, this may also indicate that the power is on but the line is deactivated.

Power/Line LED Flashes and B1 and B2 LEDs are Off

This indicates a problem with the physical connection of the ISDN line from the local telephone company to the Express XRT.

1. Verify the large end of the RJ-45 to RJ-45 cable (included with the Express XRT) is connected to the ISDN connector on the rear panel of the Express XRT.
2. Verify the other end of the RJ-45 to RJ-45 cable is connected to the ISDN NT1.
3. Contact the local telephone service provider.

Power/Line LED, B1, and B2 LEDs Flash Green

This indicates a configuration problem. Verify the following information is correct:

- Switch Type
- Service Profile Identifiers (SPIDs) (used in North America only)
- ISDN Phone Numbers

This information can be viewed by choosing the **Status Register** button under the **Diagnostics** tab of the ADTRAN Express Configuration Wizard window or the Configuration Screen in the VT 100 menu system. The Link Status should indicate **Link Up** if all configuration information is correct and the unit is properly connected. If the link status is good and calls still can not be placed, review the section for *Dial-Up Connection Problems* on page 55.

Auto-Detect can be used under the **Wizard** button in the ADTRAN Express Configuration software (or by using the **Auto-Detect SPIDs/Switch** option in the Configuration screen of the VT 100 menus) to automatically detect the SPIDs and the Switch Type. This only applies to North American switches.

1. Look for the following with the COM port setup:

- IRQ conflicts.
- Wrong DTE speed.
- Use Microsoft diagnostics (msd.exe) to verify the COM port has 16550 UART (for speeds of 115.2 kbps and below) or a 16650 UART (for speeds up to 230.4 kbps).
- Proper COM driver is installed (not provided) to support DTE speeds above 19.2 kbps.

2. Verify the correct protocol is selected:

- PPP or V.120 generally for Internet applications
- V.120 or Async BONDING for work-at-home



Power/Line LED, B1, and B2 LEDs flash green sequentially. After a software upgrade, if the Power/Line, B1 and B2 LEDs flash green in sequence, a problem occurred. Restart the download using the instructions in on page 49. If the download fails a second time, contact ADTRAN technical support.

Dial-Up Connection Problems

Many connection problems can be diagnosed by viewing the status buffer message returned from the ISDN network and the Express XRT. These messages are accessed by choosing the **Status Buffer** button in the **Diagnostics** tab of the ADTRAN Express Configuration window.

The Status buffer can also be accessed using the key sequence **Ctrl+V** in the VT 100 menu system. Issue the AT command **AT!V** from a terminal emulation package such as HyperACCESS to invoke the VT 100 menu system.

Auto-detect Switch/SPIDs Remains at Link Down



Auto-detect is only used in North America.

The Link Down condition persisting for longer than 15 minutes indicates a problem with the ISDN line provided from the telephone company. The ISDN physical layer device has not been able to synchronize to the network. Ensure the RJ-45 to RJ-45 cable is correctly installed between the Express XRT and the NT1 and that the Express XRT is powered on. Call the local telephone company and have them check the ISDN line for correct operation.

Express XRT Not Detected

If the Express Configuration Wizard cannot detect the Express XRT verify the following:

1. The Express XRT is powered on.
2. No other applications are running that could be using the COM port to which the Express XRT is attached. A Windows application does not have to be active to tie up a COM port. Be sure to check the Windows 95 Taskbar for any suspended applications (such as HyperTerminal and HyperACCESS) that may be using the COM port. If any are minimized, these must be closed before starting the Express Configuration Wizard.
3. If you are operating the Express XRT at 230.4 kbps, ensure that dip switch 1 on the rear panel is off (up). This is required for operation at 230.4 kbps. Also, confirm that the computer has a 16650 UART.

External Analog Modem Not Detected

If the Express Configuration Wizard cannot detect the external analog mode verify the following:

1. The external analog modem is powered on.
2. The external analog modem is properly installed and configured for use with the Express Configuration Wizard. See *Configuring an External Analog Modem* on page 30 for more details on the required settings.

Difficulty with 230.4 kbps Operation

If the Express XRT does not work when the DTE rate is set to 230.4 kbps inside Windows, verify the following:

1. Verify that dip switch 1 on the back of the Express XRT is set to off (up).
2. Verify that a high speed serial card with a 16650 UART is being used and the software drivers to support the extended baud rate tables are installed.

Dial-Up Networking Difficulty

If Windows 95 Dial-Up Networking cannot talk to the Express XRT, check the modem configuration for the Express XRT. Ensure the bit rate for the DTE is set correctly. If the PC is not equipped with a 16650 UART, then the fastest DTE operation speed is 115.2 kbps. Ensure the speed is not higher than the PC and modem can support.

Appendix A

AT Commands and S-Registers

AT COMMANDS

While a call is not established, the DTE port accepts AT commands. During this time, the CD signal is inactive. When a call is established, the port is used for data. This data mode is indicated by the CD signal active. The Express XRT can be configured and controlled with AT commands from a serial port similarly to analog modems.

To exit data mode and enter command mode, the serial port must transmit a proper escape sequence to the Express XRT. A specified time delay must occur between the last data character and the first escape sequence character. This is the guard time delay, and it can be changed by writing a value to the S12 register. The default value for the guard time is one second. For a valid escape sequence to occur, the DTE must transmit the escape code character three times in succession with delay between each character being less than the guard time. The default escape sequence is +++.

Once command mode is entered, AT commands can be transmitted to the Express XRT to configure most of the options, dial remote Express XRTs, or initiate tests to check both the Express XRT and the network connections. All command lines must begin with the AT character set in either capital or lower case letters. To return an active call to the on-line state type **ATO**.

The command line may contain a single command or a series of commands after the AT attention code. AT commands **_L1** and **_L0** are exceptions and must be on a separate line followed by **Enter**. When a series of commands is used, the individual commands may be separated with spaces for readability. The

maximum length for a command line is 40 characters. Each command line is executed by the Express XRT upon receipt of a terminating character. The default terminating character is a carriage return (ASCII 013), but it can be changed by writing a different value to register S3. Before the terminating character is transmitted, the command line can be edited by using the backspace character (ASCII 008) to erase errors so the proper commands can be entered.

Using an AT Command

Type **AT** followed by the letter of the command and numeric value of the setting desired and then press **Enter**. The following command returns the software version of the unit:

ATI1

Using S-Registers

The configuration of the Express XRT can be changed or reviewed with S-registers. See the section *S-Register List* on page 63 for a description of each S-register and its corresponding range of values.

Reading an S-Register

Type **ATS** followed by the number of the S-register to be read followed by a question mark and press **Enter**.

ATS0?

Reading an S-Register String

The Express XRT uses S-register strings to store strings of digits for stored phone numbers, SPIDs, etc. Type **ATSS** followed by the number of the string S-register to be read followed by a question mark and press **Enter**.

ATSS80?

Changing an S-Register

Type **ATS** followed by the number of the S-register to be changed, an equal sign, the numeric value to be assigned to the register, then press **Enter**.

ATS0=2

Changing a String S-Register

Type **ATSS** followed by the number of the string S-register to be changed, an equal sign, the numeric string to be assigned to the register, then press **Enter**.

```
ATSS80=5551212
```

Dialing a Call using the AT Command Processor

To dial a call using the DTE terminal and AT commands, type **ATD**, **ATDT**, or **ATDP** and the telephone number on one line and press **Enter**.

```
ATD5551212
```

To end an active call with the AT command processor, press the break in key sequence **+++** or the redefined key then type **ATH** and press **Enter** to hang up the line.

Command	Function
A	Answer. Places the Express XRT in answer mode.
AT!DATE	Current date in the format of DDMMYY.
AT!FLASHLOAD	Initiate the flash software update. The terminal must be set for 57,600 bps, 8 data bits, no parity, and 1 stop bit.
AT!NAME1	Displays the Calling Party name from the last call on PORTS port 1.
AT!NAME2	Displays the Calling Party name from the last call on POTS port 2.
AT!NUMBER1	Displays the Calling Party number from the last call on POTS port 1.
AT!NUMBER2	Displays the Calling Party number from the last call on POTS port 2.
AT!S	Displays Status Buffer.
AT!S1	Displays Link Status
AT!TIME	Current time in the format of HHMMSS.
AT!V	Configuration Menu
AT!Z	Detect a modem connected to the Express XRT
D	Dial. Precedes the telephone access number [ATD5551212].
H	Hang up. Disconnects the current call.

Appendix A. AT Commands and S-Registers

I0	Identify unit. Commands the unit to display model number.
I1	Identify software. Commands the unit to display software version.
O	On-line. Commands the unit to go back on line
S	S Register.
S36	Inactivity Timer in minutes (0-255). 0=inactivity timer off.
S37	Flash Hook button function 0=Flash (Call Waiting) 1=Conference
SS	S String register.
&V	Displays the contents of all S registers.
Z	Reset. Resets the AT command processor.
&W	Save. Save current configuration to EEPROM.
+++	Break in. Break in AT command processor during an active call. The break in key is defined in S2.

Carrier Detect (CD) Control Line Options

&C0	CD forced on.
&C1	CD normal.
&C2	CD off with local disconnect (LOCD)
&C3	CD off with link down.

Data Terminal Ready (DTR Control Line Options)

&D0	Ignore DTR
&D1	DTR off forces command.
&D2	Idle when off. DTR off forces idle (On allows auto answer).

Command Function

Generic Unit Configurations

&F0	Factory Default (fallback auto-protocol detect)
&F1	Internet 64K
&F2	Internet 128K
&F4	Remote Access 128K
&F7	Configures unit for Dial 57.6k async
&F8	Configures unit for Dial 115.2k async
&F11	Configures unit for FALLBACK

Calling Number Identifiers

&N0	Number 1. Read far-end phone number 1 if service subscribed from telephone company.
&N1	Number 2. Read far-end phone number 2 if service subscribed from telephone company.

Clear-To-Send (CTS) Control Line Options

&R0	Follows RTS
&R1	Forced CTS

Data Set Ready (DSR) Control Line Options

&S0	DSR forced on
&S1	DSR if call up
&S2	DSR off if link down

Accessing Stored numbers for Dialing Options*

&Z0	Stored number 0
&Z1	Stored number 1
&Z2	Stored number 2
&Z3	Stored number 3
&Z4	Stored number 4
&Z5	Stored number 5
&Z6	Stored number 6
&Z7	Stored number 7
&Z8	Stored number 8
&Z9	Stored number 9

**These presets are invoked by &Z0 through &Z9 AT commands. They access the stored numbers used for dialing.*

Command Function**Local Echo Options**

E0	Echo off. Does not allow command characters typed to be displayed on the screen.
E1	Echo on. Allows the command characters typed to be displayed on the screen.

AT Command Response Message Options

Q0	Response messages on
Q1	Response messages off

AT Command Response Message Types

V0	Numeric response messages
V1	Verbal response messages

AT Command Connect Message Options

X0	Simple connect message
X1-7	Connect messages with bit rate

Ready-To-Send (RTS) Control Line Options

_D0	1 mS delay
_D1	18 mS delay

ISDN Switch Type Options

_S0	5ESS
_S1	DMS-100
_S2	National ISDN-1
_S3	NEC
_S4	Euro ISDN

Data Flow Control Options

\Q0	No flow control
\Q1	Software flow control (XON/XOFF)
\Q2	CTS only
\Q3	Hardware flow control (RTS/CTS) factory default
\Q4	Software from DCE only

DTE and Modem Interface Selection

_L0	Disable external analog modem connected to the Express XRT modem port.
_L1	Enable external analog modem connected to the Express XRT modem port.

S-REGISTER LIST

S0	AUTO ANSWER	Determines how the Express XRT answers an incoming call. 0 = Disable (Express XRT does not answer call). 1 = Enable (Express XRT answers all calls). 2 = Dump all calls.
S2	ESCAPE CHARACTER	Determines which key or character (in ASCII code) defines the escape command. The standard escape character is a plus (+) sign (ASCII value of 43 decimal). To change the character set, set S2 to the desired ASCII value. Range = 0 to 127
S3	END OF LINE CHARACTER	Determines which key or character (in ASCII code) ends a command line. The standard end-of-line character is the carriage return (ASCII value of 13 decimal). Range = 0 to 127
S4	LINE FEED CHARACTER	Determines which key or character (in ASCII code) advances the cursor to the next line after ending a command line or after an Express XRT message. The standard character is the line feed (ASCII value of 10 decimal). Range = 0 to 127
S5	BACK SPACE CHARACTER	Determines which key moves the cursor back one space to erase a character. The standard character is the backspace (ASCII value of 8 decimal). Range = 0 to 127
S7	CONNECT TIME	Determines how long the Express XRT waits for an outgoing call to be answered. 15 = 15 seconds 30 = 30 seconds 60 = 1 minute 120 = 2 minutes 240 = 4 minutes
S8	Call Rejection	Determines which incoming voice calls the Express XRT will reject. 0=Disables 1=Reject anonymous calls only 2=Reject calls on call rejection list only 3=reject anonymous and call rejection list numbers

S12	ESCAPE TIME	Determines the delay required immediately before and after entering the escape command for the Express XRT to recognize and execute the command. Range = 0 to 127
S14	MISC BITS	Miscellaneous bits (bit 8 is most significant bit). Bit 2 = 1: Enables on screen echo of AT commands. Bit 2 = 0: Disables on screen echo of AT commands. Bit 3 = 0: Enables AT responses from the Express XRT. Bit 3 = 1: Disables AT responses from the Express XRT. Bit 4 = 1: Enables AT responses to be displayed in text form. Bit 4 = 0: Enables AT responses to be displayed in numeric form. Bit 5 = 0: Do not toggle Bit 5 = 1: Toggle E Bit 80 <-> BF when using V110 Bit 7 = 1: Disable PPP ACCM spoofing. Bit 7 = 0 Enable PPP ACCM spoofing. Bit 8 = 1: Ring indicator uses cadence. Bit 8 = 0: Ring indicator remains on.
S15	ASYNC BONDING	Asynchronous BONDING method. 0 = ADTRAN revision 0 (default) 1 = Multi-vender option
S22	MSG BITS	Miscellaneous message bits (bit 8 is most significant bit). Bit 5= Bit 6 = Bit 7 = 1 Allows connect message with baud rate. Bit 5= Bit 6 = Bit 7 = 0 Connect message without baud rate.
S25	DTR DETECT TIME	Determines time, in hundredths of a second, that must elapse before the Express XRT recognizes a change in DTR. Range = 0 to 255
S27	PPP MODE	Value determines whether or not PPP will be a single-link or multilink connection. 0=Single-link operation (default) 1=Multilink operation 2=Use compression
S30	DTE CTS	Controls the operation of the DTE connector CTS line. 0=Follows RTS 1=Force CTS

S31	DTE RTS	Controls operation of the RTS line. 0=1 ms delay 17=18 ms delay
S32	DTE DSR	Controls the operation of the Data Set Ready signal on the DTE connectors. 0=Force DSR on always 1=DSR off OOS + Test 2=DSR off Link Down
S33	DTE CD	Controls the operation of the Carrier Detect line on the DTE connectors. 0=Force CD on always 1=CD is active during a call (Normal Operation) 2=Off with LOCD 3=Off link down
S34	DTE DTR	Determines how the Express XRT responds to changes in DTR. This is a bit-mapped register. 0=Ignore DTR 1=Force AT command mode when DTR is off 2=Dump incoming call when DTR is off 4=Hang up incoming call when DTR is off 8=Hang up outgoing call when DTR is off 16=Answer incoming call when DTR is on 28=Idle when off 32=Dial SN0 when DTR is on 64=Dial SN0 when DTR transitions from off to on
S36	Inactivity Timer	0=Off 1-255=Number of idle minutes before disconnect
S37	Conference/Call Waiting	Flash hook button defaults to: 0=Call waiting 1=Call conferencing
S40	BOND TXINIT	Specifies the number of seconds the originating endpoint attempts to detect the Async BONDING negotiation pattern from the answering endpoint before deciding the Async BONDING call has failed. 0 to 255, 10 sec is default.

S41	BOND TXFA	Specifies the number of seconds both endpoints attempt to detect the async BONDING frame pattern when a call is connected before deciding the async BONDING call has failed. When operating with other manufacturer's async BONDING equipment it may be necessary to lengthen this timer so that it matches TXADD01. 0 to 255, 10 sec is default.
S42	BOND TXADD	The number of seconds both endpoints wait for the additional call to be connected at the end of negotiation before deciding the async BONDING call has failed. When dialing overseas it may be necessary to lengthen this timer to allow for slower call routing. 0 to 255, 50 sec is default
S43	BOND TXDEQ	The number of seconds both endpoints attempt to equalize the network delay between the bearer channels before deciding the Async BONDING call has failed. 0 to 255, 50 sec is default
S44	BOND TANULL	The number of seconds the answering endpoint attempts to detect the Async BONDING negotiation pattern from the originating endpoint before aborting to clear channel mode. It may be necessary to shorten this timer if the DTE equipment connected to the Express XRT also has timer constraints for completing non-BONDING parameter negotiation. 0 to 255, 10 sec is default
S45	BOND TCID	The number of seconds both endpoints attempt to negotiate agreeable values for bearer channels and channel capacities before deciding the async BONDING call has failed. 0 to 255, 5 sec is default
S52	SWITCH TYPE	Selects the network switch type for dial service. 0=AT&T 5ESS 1=Northern Telecom DMS-100 2=National ISDN-1 3=NEC 4=EuroISDN

S53	CALL TYPE	Call type (Dial service only). 0=Speech 1=Audio 2=56 Kbps data 3=64 Kbps data
S54	PROTOCOL TYPE	Rate adaption protocol type. 2=Async BONDING 5=V110 6=V.120 11=Fallback 12=PPP async-to sync conversion
S58	CALL SCREEN-ING	Allows the Express XRT to screen incoming calls. 0=Answer any call 1=Answer only calls from numbers matching those stored in SN0 through SN9.
SS60	SPID1 LOC	SPID string location (only for use in North America).
SS61	SPID2 LOC	SPID string location (only for use in North America).
SS62	LDN1 LOC	ISDN phone number string location.
SS63	LDN2 LOC	ISDN phone number string location
S65	AUTOSPID	Sets the AutoSpid determination feature (only for use in North America). 0=Disable (default) 1=Enable
SS67	AREA CODE	Area code location (only for use in North America).
S71	DTE RATE	Selects the DTE connector bit rate. 3 = 1200 6 = 2400 8 = 4800 11 = 9600 15 = 19200 17 = 38400 20 = 57600 23 = 115200 25 = 230400
S72	DATA BITS	Selects the number of asynchronous data bits. 0 = 8 bits 1 = 7 bits

S73	DTE PARITY	Selects the number of asynchronous parity bits. 0=None 1=Odd 2=Even
S74	DTE STOP	Selects the number of asynchronous parity bits. 0=None 1=Odd 2=Even
S75	DTE FLOW	Selects asynchronous flow control. 0=None 1=XON/OFF from DTE controls DCE 2=XON/OFF from DCE controls DTE 3=Hardware 12=Software
SS77	REMOTE NUMERIC PASSWORD	Numeric password string for remote configuration.

The following are the string locations for stored numbers 0 - 9:

SS80	SN0 LOC	Stored number 0 string
SS81	SN1 LOC	Stored number 1 string. Used for second number dialed in a multilink connection.
SS82	SN2 LOC	Stored number 2 string
SS83	SN3 LOC	Stored number 3 string
SS84	SN4 LOC	Stored number 4 string
SS85	SN5 LOC	Stored number 5 string
SS86	SN6 LOC	Stored number 6 string
SS87	SN7 LOC	Stored number 7 string
SS88	SN8 LOC	Stored number 8 string
SS89	SN9 LOC	Stored number 9 string
S90	CONFERENCE ID	NI-1 feature identification number for conferencing. See the ISDN service provider for this ID.
S91	TRANSFER ID	NI-1 feature identification number for transferring. See the ISDN service provider for this ID.
S92	MESSAGE WAITING ID	NI-1 feature identification number for message waiting indicator. See the ISDN service provider for this ID.

S93	CALL TYPE ROUTING	Determines how incoming call is routed when connected to a point-to-point ISDN line. 0=Route all call types to DTE 1=Route Speech call types to POTS 2=Route Speech and Audio call types to POTS
S94	LOCAL TONES	Forces the POTS interface to generate all tones. Bit 0=0:In-band tones from ISDN switch (when available) Bit 0 =1:All tones generated locally Bit 1 =0: Warnings to POTS when unavailable Bit 1 =1:Disable all warnings to POTS
S118	CHAP Enable	32 = CHAP enabled (Windows 95 setting) 0 = CHAP disabled
S129	COUNTRY	Configures the POTS interface to generate tones 0=North America 3=Hong Kong 5=Korea 8=New Zealand 9=Philippines 10=Singapore 11=South America 12=United Kingdom 13=Australia 14=United Arab Emerates
SS 130	CR0 LOC	Call Reject List Number 0
SS 131	CR1 LOC	Call Reject List Number 1
SS 132	CR2 LOC	Call Reject List Number 2
SS 133	CR3 LOC	Call Reject List Number 3
SS 134	CR4 LOC	Call Reject List Number 4
SS 135	CR5 LOC	Call Reject List Number 5
SS 136	CR6 LOC	Call Reject List Number 6
SS 137	CR7 LOC	Call Reject List Number 7
SS 138	CR8 LOC	Call Reject List Number 8
SS 139	CR9 LOC	Call Reject List Number 9

Appendix B

LEDs

LEDs

The Express XRT front panel contains five LEDs associated with the DTE port and the ISDN interface as shown in Figure B-1 and described in Table B-A.

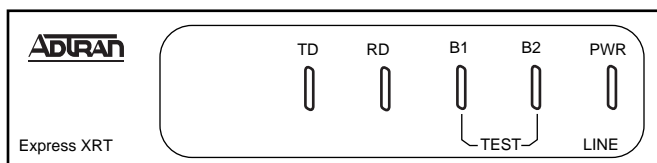

Figure B-1
Front Panel LEDs

Table B-A
Express XRT LEDs

LED	Color	Description
B1 or B2	Slow Green Flash Fast Green Flash Off Solid Green Solid Amber Amber Flash	Attempting SPID registration. Attempting TEI registration. Ready. No data traffic. B Channel passing data (in use). Loopback protocol test (one or both channels). Remote test originate.

Table B-A
Express XRT LEDs

LED	Color	Description
PWR/Line	Green (On Solid) Off	Link Established. No Power or link is not established. In North America a flashing light indicates that the link is not established. In Europe, it means the link is not active.
TD	Green	Transmit Data (TxD)
RD	Green	Received Data (RxD)

Appendix C

Status Buffer Messages

2047 BERT orig

Test remote originated 2047 BERT (bit error rate test) pattern.

2047 loopbk ansr

Test remote answered 2047 BERT pattern.

Answer

The Express XRT answered a call on either the first or second channel. The calling phone number is displayed if available.

ACCESS_INFO DISCARDED

The network was unable to deliver access information to the far end.

Area Code Req'd

Area code required for Auto Spid determination.

AutoSpid Active

Unit is attempting automatic detection of switch type and SPID numbers.

AutoSpid Disable

The user has stopped the automatic SPID detection process.

AutoSpid Failed

Automatic determination of switch type and SPID numbers failed.

AutoSpid Passed

Automatic determination of switch type and SPID numbers succeeded.

AutoSwitch YYY

Switch type YYY detected during AutoSpid determination. (YYY can be DMS, NI-1, or AT&T)

Back to online

Express XRT went back on line.

Bad async BPS

The Bonding protocol determined that the selected asynchronous bit rate is not supported.

Bad AT numeric

User issued an AT command with an argument that was out of range.

Bad call type

Express XRT placed a call with an improper call type.

Bad DTE Baud

The DTE bit rate does not match a valid bit rate for the protocol selected.

BAD_INFO_ELEM

Call control error.

Bad phone number

Express XRT attempted to call an invalid phone number.

BEAR_CAP_NOT_AVAIL

The bearer channel requested is not available.

BEARER_CAP_NOT_AUTH

Bearer capability requested is not authorized.

Bearer Mode?

Incoming call is not of a type the Express XRT can accept.

Bearer Info Cap?

Incoming call information transfer capability is not known.

BONDING (+/-XXX)

The amount of bytes or corrected delay between the B2 and B1 Bearer channels (XXX can range from -8000 to +8128).

BPS mismatch

Bonding negotiation found a bit rate mismatch.

Break to AT cmd

User issued a break-in request.

Break ignored

User issued an extra break-in request.

BUSY

The called number is busy.

B-X disconnected

B-channel disconnected. X can be 1 or 2 representing the appropriate B-channel.

CallID 1 in use

The Express XRT tried to place a call using SPID 1 when SPID 1 was already in use.

CallID 2 in use

The Express XRT tried to place a call using SPID 2 when SPID 2 was already in use.

Call lost

Held call could not be retrieved.

Call not ringing

User executed an answer command (ATA) but there was not a call present.

CALL_REJECTED

The call has been rejected by the ISDN network.

Can't go online

Express XRT cannot go back on line. Unknown AT command user issued an unknown AT command.

CHAN_DOES_NOT_EXIST

The user asked for a bearer channel that is not present.

CHAN_NOT_IMPLEMENTED

The network or far end does not support the bearer capability requested.

CHANNEL_UNACCEPTABLE

The channel requested has not been subscribed.

CID>0 rcvd

Received an incoming call from a third party during negotiations with a far-end BONDING unit on the use of the second Bearer channel.

Connect Timeout

Call attempt does not connect in x amount of time.

Deactivated

No signal (INFO0) between Express XRT and NT1.

DEST NOT ISDN

The number called is not ISDN (warning only).

DEST_OUT_OF_ORDER

The called number is out of order.

Dial

The Express XRT placed a call on either the first or second channel. The number called is displayed following the message.

Disconnect

The call on either the first or second channel was disconnected from the network. The far-end phone number is displayed if available. Ensure flow control setting match on both terminal adapters.

Disconnected

Layer 1 is up (INFO4 received) but no layer 2 or 3 activity. This is the normal state of a EuroISDN switch if no call is active and the switch has not dropped layer 1 (physical layer).

Disconnect Req

Far-end unit disconnected during BONDING negotiation.

DTR not up

Express XRT tried to place a call in a dialing mode that requires DTR to be in an active state, but it is not.

Dump call

The Express XRT could not accept an incoming call because it was already involved in a call.

Dump

An incoming call on either the first or second channel was discarded by the Express XRT. The calling number is displayed if available.

FACILITY_NOT_IMPLEMENT

The network does not support the requested supplementary service.

FACILITY_NOT_SUBSCRIBED

The channel type requested has not been subscribed.

FACILITY_REJECTED

A facility requested by the user cannot be provided by the network.

Factory Reset 0

Unit defaulted to factory configuration.

FlowCtl mismatch

Bonding negotiation determined a flow control mismatch.

FlowCtl required

Bonding negotiation determined that flow control needs to be optioned on.

Hangup

The call on either the first or second channel was disconnected by the Express XRT. The far-end phone number is also displayed.

Hold

Voice call is on hold.

ID = XXXX

Calling party number.

INCOMING_CALL_BARRED

The network will not allow an incoming call.

INCOMPATIBLE_DEST

The called number cannot accept the type of call that has been placed.

INTERWORKING_UNSPEC

A non-ISDN network sent an unspecified message.

Inv Password

Remote configuration failed due to incorrect password.

INVALID_CALL_REF

Call control error.

INVALID_ELEM_CONTENTS

Call control error.

INVALID_MSG_UNSPEC

Invalid message: protocol error.

INVALID_NUMBER_FORMAT

The dialed number has an invalid format.

L1 not up

The network interface is not active.

L2 not up

The data link layer interface is not active.

L3 not up

The call control interface is not active.

L2 #2 not up

The data link layer interface for a second call (BONDING) is not active.

L3 #2 not up

The call control layer interface for a second call (BONDING) is not active.

LDN TOO LONG

The local directory number entered has too many digits.

Login failed

Unable to connect to remote unit on remote configuration attempt.

MANDATORY_IE_LEN_ERR

Mandatory information element length error.

MANDATORY_IE_MISSING

Mandatory information element missing.

MULTILINK PPP UP

Unit connected with Multilink PPP.

Need 64K call

The BONDING protocol requires the Express XRT to be configured for 64K data call types.

NETWORK BUSY

The ISDN switch is busy and unable to process a call.

NETWORK_CONGESTION

The phone network is currently congested.

NETWORK_OUT_OF_ORDER

The phone network is out of order.

No calling ID

Calling party number not provided.

NO_CIRCUIT_AVAILABLE

The requested bearer channel is not available.

NONEXISTENT_MSG

Nonexistent/undefined message received from network.

**NO_ROUTE
NO_ROUTE_DEST**

The phone network was unable to find a route to the destination number.

No Sreg number

Attempted to change an S-register but did not specify a specific S-register (example: ATS=1).

No Sreg value

Attempted to change an S-register but did not specify a value (example: ATS=).

No String Space

Stored number string space is full.

NO_USER_RESPONDING

The dialed number is not responding.

NORMAL_CLEARING

The network is disconnecting the current call.

NOT_end2end ISDN

The path that the call was routed over is not ISDN from end-to-end (warning only).

NUMBER_CHANGED

The number dialed has been changed.

OUTGOING_CALL_BARRED

The network will not allow the outgoing call to be placed.

Phone # Req'd

Phone number required for AutoSpid determination.

PPP COMPRESSION UP

Unit connected with compression.

PPP LINK LOOPBACK

Network link is looped backed.

PPP Timeout

PPP negotiation failed.

PROTOCOL_ERROR

Call control error.

PUMPIO: dpump-quit

Rate adaption stopped due to DTE error.

Rcv Cause XXX

Undefined cause message received.

REQ_CHANNEL_NOT_AVAIL

The channel type requested is currently not available.

Remote not ISU

Bonding negotiation determined the far-end unit is not another ISU product.

RESOURCE_UNAVAIL

The requested resource is unavailable.

RESP_TO_STAT_ENQ

Response to status enquiry.

Restarting Rate

Unit restarts DTE rate.

Retrieve

Voice call is retrieved from a holding state.

Ring

An incoming call on either the first or second channel (third channel if call waiting) entered the Ring state. The calling phone number is displayed if available.

S cmd not = or ?

Proper syntax not used.

SERVICE_NOT_AVAIL

The requested service is not available.

SOURCE_NOT_ISDN

The incoming calling party is not ISDN (warning only).

TANULL expired

Bonding timer TANULL expired. Received call from non-BONDING equipment.

TEMPORARY_FAILURE

The network has temporarily failed, try the call again.

TIMER_EXPIRY

Call control error.

TXADD01 expired

Bonding timer TXADD01 expired.

TXDEQ expired

B-channel delay equalization during bonding failed.

TXFA1 expired

Bonding timer TXFA1 expired.

TXFA2expired

Bonding timer TXFA2 expired.

TXINIT expired

Bonding timer TXINIT expired; called non-BONDING equipment.

UNASSIGNED_NUMBER

The phone number dialed does not exist.

Unknown AT cmd

User issued an unknown AT command.

USER_ALERT_NO_ANS

Ringing call is not answered.

USER_BUSY

The dialed number is busy.

V120 connected

The V.120 rate adaption successfully connected to the far-end unit.

V120 Timeout

V.120 negotiation failed.

WRONG_MESSAGE

Call control error.

WRONG_MSG_FOR_STATE

Call control error.

Appendix D

Loop Status Messages

This appendix lists the status line messages and their definitions. Messages shown entirely in capital letters are generated by the ISDN network. Messages with lower case letters are generated by the Express XRT.

AutoSpid X

The SPID is being attempted by the AutoSpid determination. X starts at 0 and counts up for each SPID tried.

Call Connect B1

Bearer channel 1 is connected and is active.

Call Connect B2

Bearer channel 2 is connected and is active.

Call Connect B1/B2

Bearer channels 1 and 2 are active.

Deactivated

No signal (INFO0) between Express XRT and NT1.

Disconnected

Layer 1 is up (INFO4 received) but no layer 2 or 3 activity. This is the normal state of a EuroISDN switch if no call is active and the switch has not dropped layer 1 (physical layer).

Disconnecting

The current phone call is being disconnected (hung up).

Getting TEI #1

The Express XRT is receiving its first TEI from the network.

Getting TEI #2

The Express XRT is receiving its second TEI from the network.

Link Down

The network interface is not in sync.

Network Loopback

The Express XRT has been commanded to perform an ISDN loopback toward the network.

Ready

The unit is ready to make or accept a call.

Register SPID #1

The Express XRT is registering its first SPID with the network.

Register SPID #2

The Express XRT is registering its second SPID with the network.

Ringling

The phone number just dialed is ringing.

xxxxx nnnn

A rate adaption is running at the bit rate specified by nnnn.

xxxxx Quitting

A rate adaption protocol is turning off.

xxxxx Ready

A rate adaption protocol is ready.

xxxxx Setup

A rate adaption protocol is setting up.

YYYY

ISDN switch-type selected.

xxxxx can be any of the following:

Bonding

Bandwidth on demand industry users group protocol.

PPP

Point-to-point rate adaption protocol.

V120

V.120 rate adaption protocol.

Appendix D. Loop Status Messages

Appendix E

Connector Pinouts

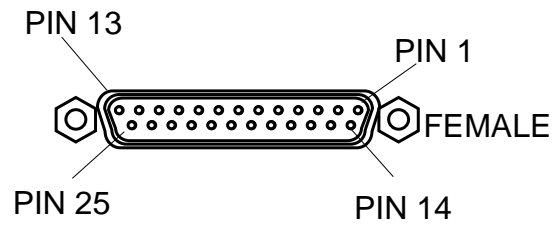

Figure E-1
RS-232 Interface

Table E-A
RS-232 Interface

Pin	Name	I/O	Description
1	Shield	I/O	Shield for cable
2	TD	I	Transmitted Data
3	RD	O	Received Data
4	RTS	I	Request to Send
5	CTS	O	Clear to Send
6	DSR	O	Data Set Ready
7	SG	I/O	Signal Ground
8	CD	O	Carrier Detect

Table E-A
RS-232 Interface

Pin	Name	I/O	Description
20	DTR	I	Data Terminal Ready
22	RI	O	Ring Indicator

I = Input O = Output

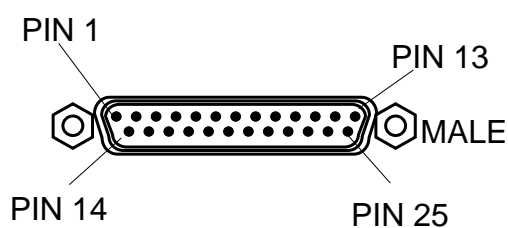

Figure E-2
Modem Interface

Table E-B
Modem Interface

Pin	Name	I/O	Description
1	Shield	I/O	Shield for cable
2	RD	O	Received Data
3	TD	I	Transmitted Data
4	RTS	O	Request to Send
5	CTS	I	Clear to Send
7	SG	I/O	Signal Ground
8	CD	I	Carrier Detect
20	DTR	O	Data Terminal Ready

I = Input O = Output

The RJ-11 POTS ports apply to the Express XRT only.

Table E-C

RJ-11 POTS Port Interface

<p>POTS 1 Interface</p> 	Pin 1
	Pin 2
	Pin 3 R1
	Pin 4 T1
	Pin 5
	Pin 6
<p>POTS 2 Interface</p> 	Pin 1
	Pin 2
	Pin 3 R2
	Pin 4 T2
	Pin 5
	Pin 6

Table E-D

RJ-45 ISDN Line Interface

	Pin 3	Transmit 1
	Pin 4	Receive 1
	Pin 5	Receive 2
	Pin 6	Transmit 2

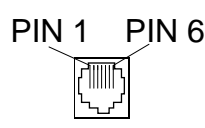
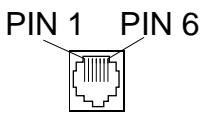
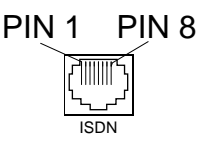
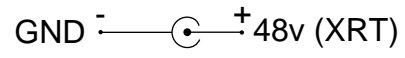

Figure E-3
Express XRT Ground Pinouts

Index

Numerics

230.4 operation
difficulty with 56

A

analog modem
connect internal 36
connecting 28
controlling 31
application configuration 37
async bonding 128k (remote access) 39
AT commands 57
dialing a call 59
using 58
auto-detect
SPIDs 18
switch 55
switch type 18
automatic redial 14

B

B1 and B2 LEDs
flash green 54
Off 53
basic telephone service
telephone service 13
BBS 46

bulletin board service 46

C

call waiting 13
Chameleon 40
conference calling 13
configuration
application 37
factory default 37
PPP 64k (internet) 38
profile 38
configuring
external analog modem 30
connecting
Express XR/XRT 5, 6
external analog modem 28
internal analog modem 36
connection tab 18
control panel modem installation 8
controlling
external analog modem 31
creating
custom profile 40
custom profile
create 40

D

defining
user program button 42

-
- dialing a call with AT commands 59
 - dial-up
 - connection problems 55
 - networking 23
 - difficulty with 56
 - dip switches 5, 6
 - disable
 - modem 33
 - terminal emulation modem 35
 - E**
 - enable
 - modem 31
 - terminal emulation modem 33
 - enable/disable modem 22
 - Express Configuration Wizard 15, 39
 - connection tab 18
 - installing 11
 - installing software 7, 9
 - starting 39
 - Express XR/XRT
 - connecting 6
 - installing 5
 - overview 1
 - external analog modem 27
 - configure 30
 - controlling 31
 - not detected 56
 - settings 30
 - F**
 - factory
 - async bonding 128K (remote access) 39
 - multilink PPP 128K (internet) 38
 - V.120 64K (remote access) 39
 - factory default configuration 37
 - front panel LEDs 71
 - G**
 - general requirements 2
 - getting started 1
 - ground pinouts 90
 - H**
 - help 19
 - HyperAccess 46
 - defining a custom session 46
 - I**
 - INF
 - installing 11
 - installing
 - analog modem 27
 - Express Configuration Wizard 11
 - Express Configuration Wizard software 9
 - Express XR/XRT 5
 - INF 11
 - modem via Control Panel 8
 - software 7
 - software on Windows 95 8
 - software on Windows NT 4.0 8
 - Windows 95 dial-up networking 23
 - internal analog modem application 35
 - internet access 40
 - internet access application 7
 - internet/remote access 7

-
- L**
- LEDs 71
 - front panel 71
 - link down 55
 - loop status messages 83
- M**
- Macintosh
 - installation 12
 - requirements 2
 - modem
 - configure external analog 30
 - disable 33
 - enable 31
 - enable/disable 22
 - external settings 30
 - interface 88
 - internal application 35
 - multilink PPP 128K (internet) 38
- N**
- NetManage 40
- O**
- on-line help 19
 - overview 1
- P**
- package contents 3
 - PC requirements 2
 - phone number allocation 14
 - play and play 8
 - Power/Line LED
 - flash green 54
 - flashes green 53
 - off 53
 - Power/Line LED is Off 53
 - PPP 64K (internet) 38
 - preferences tab 20
 - product overview 1
 - profile
 - configuration 38
 - create custom 40
 - properties 22
- R**
- rear panel dip switches 6
 - refresh 22
 - remote access 7, 40
 - requirements
 - general 2
 - Macintosh 2
 - PC 2
 - RJ-11 POTS port interface 89
 - RJ-45 ISDN line interface 89
- S**
- settings
 - verify switch settings 5
 - Shiva Remote 40
 - single phone number operation 14
 - software
 - installation 7
 - SPIDs
 - auto-detect 18
 - remians at link down 55
 - S-register
 - changing a string 58, 59
 - list 63
 - reading 58
 - reading a string 58
 - using 58
 - start installation 1

Index

starting
 express configuration wizard
 39

status buffer messages 73

supplementary voice service 13

switch
 1 5
 2 6

switch settings
 verify 5

switch type
 auto-detect 18

terminal status buffer 25

W

what Adtran provides 3

T

terminal emulation 24
 modem disable 35
 modem enable 33

terminal status buffer 25

tray tool 19
 menu 22

U

unknown state icon 21

user program button 42

using
 express configuration wizard
 15
 help 19

V

V.120 64K (remote access) 39

V110 67

verify switch settings 5

voice service 13

VT 100
 configuration 24
 terminal emulation 24



NO POSTAGE
NECESSARY
IF MAILED
IN THE
UNITED STATES

BUSINESS REPLY MAIL

FIRST-CLASS MAIL PERMIT NO. 9008 HUNTSVILLE, AL

POSTAGE WILL BE PAID BY THE ADDRESSEE

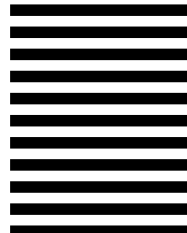

ATTN: LITERATURE DEPT
ADTRAN INC
PO BOX 140000
HUNTSVILLE AL 35814-9966



fold



**Register now to be included in our
Preferred Customer Database!
You'll receive new product information and
product updates. Take a few minutes to fill out
this registration card. Postage is paid.
Thank you!**

ADTRAN provides a broad line of end-user equipment that supports a wide range of business applications for host and remote sites including: ISDN terminal adapters, inverse multiplexers, NT1s, 56k DDS DSU/CSUs, T1 DSU/CSUs, and multiplexers. ADTRAN is also a leading supplier of DDS, ISDN, and T1/HDSL digital loop products for the telephone operating companies and many well known OEMs. For more information, select the appropriate box.

End-User Equipment

- ISDN
- DDS
- T1

Telephone Company Equipment

- ISDN
- DDS
- T1/HDSL
- Wireless

DO NOT STAPLE. Registration form continued inside.



Express XRT Warranty Registration Card

First Name	Middle Initial	Last Name
Company Name		
Address		
City	State	Zip Code
Daytime Phone		Fax
E-mail Address		

Date Purchased: _____

Model purchased: _____

Serial Number: _____

Where did you purchase:

Where do you use a computer:
(check all that apply):

- Office
- Home
- On the road

Where will you use this ISDN modem?

- Business
- Home

What primary application will this product be used for (check all that apply):

- Internet access
- Work at home
- Modem replacement
- Other

What operating system do you use?

- OS/2
- Windows 95
- Windows 3.1
- DOS
- Mac OS
- Other

How did you learn about ADTRAN:

- Advertisement
- Article/review
- Value Added Reseller
- Catalog
- Friend/colleagues
- ADTRAN Home Page
- Retail Store
- Other

Did the equipment operate properly: Yes No

First try Yes No

Successive attempts: Yes No

Which features do you like?

Which features do you dislike?

On-Line Services

ADTRAN Internet Homepage: <http://www.adtran.com>

The ADTRAN Internet homepage contains an ISDN Info Desk with the following information:

- General product information
- Modem scripts for popular software applications
- Frequently asked questions (FAQs) about common telecommunication issues.
- Setup information for ADTRAN ISDN products.

Electronic Mail: support@adtran.com

Electronic mail technical support allows customers to ask general questions and post noncritical technical support issues about ADTRAN products and services. A 24-hour response time can be expected.

Fax Service: 205-963-7941

Field support questions are accepted by fax at this number.

FAXBack Service: 205-963-8200

ADTRAN documentation and support notes can be easily faxed to you by calling and following the simple instructions to request the documents you need.

Pre-Sales Inquiries and Application Support

For Reseller or End-User

Based on the information needed, please contact your local Distributor, Dealer, or Reseller first. If they are unable to assist you, call Applications Assistance at (800) 615-1176 for product usage questions or Inside Sales at (800) 827-0807 for list price, availability, and purchase locations nearest you.

Post-Sales Support

For Reseller or End User

Based on the information needed, please contact your local Distributor, Dealer, or Reseller first. If they are unable to assist you, call ADTRAN Technical Support at (888) 4-ADTRAN and have the unit serial number available.