



# **NetVanta 3100 Series Fixed Port Routers Hardware Installation Guide**

1700600L2	NetVanta 3120 (with DBU)
1700601G2	NetVanta 3120 (without DBU)
1700610L2	NetVanta 3130 Annex A (with DBU)
1700611G2	NetVanta 3130 Annex A (with DBU)
1700612G2	NetVanta 3130 Annex B (without DBU)

## Trademarks

Any brand names and product names included in this manual are trademarks, registered trademarks, or trade names of their respective holders.

## To the Holder of the Manual

The contents of this manual are current as of the date of publication. ADTRAN reserves the right to change the contents without prior notice.

In no event will ADTRAN be liable for any special, incidental, or consequential damages or for commercial losses even if ADTRAN has been advised thereof as a result of issue of this publication.

## Software Licensing Agreement

Each ADTRAN product contains a single license for ADTRAN-supplied software. Pursuant to the Licensing Agreement, you may: (a) use the software on the purchased ADTRAN device only and (b) keep a copy of the software for backup purposes. This Agreement covers all software installed on the system, as well as any software available on the ADTRAN website. In addition, certain ADTRAN systems may contain additional conditions for obtaining software upgrades.



*Changes or modifications to this unit not expressly approved by the party responsible for compliance could void the user's authority to operate the equipment.*



901 Explorer Boulevard  
P.O. Box 140000  
Huntsville, AL 35814-4000  
Phone: (256) 963-8000

Copyright © 2012 ADTRAN, Inc.  
All Rights Reserved.  
Printed in U.S.A.

## Conventions

**NOTE**

*Notes provide additional useful information.*

**CAUTION**

*Cautions signify information that could prevent service interruption or damage to the equipment.*

**WARNING**

*Warnings provide information that could prevent injury or endangerment to human life.*

## Safety Instructions

When using your telephone equipment, please follow these basic safety precautions to reduce the risk of fire, electrical shock, or personal injury:

1. Do not use this product near water, such as a bathtub, wash bowl, kitchen sink, laundry tub, in a wet basement, or near a swimming pool.
2. Avoid using a telephone (other than a cordless type) during an electrical storm. There is a remote risk of shock from lightning.
3. Do not use the telephone to report a gas leak in the vicinity of the leak.
4. Use only the power cord, power supply, and batteries indicated in the manual. Do not dispose of batteries in a fire. They may explode. Check with local codes for special disposal instructions.
5. The socket-outlet shall be installed near the equipment and shall be easily accessible.

If any of the following conditions occur, unplug the product from the electrical outlet and replace the part or contact your qualified service personnel:

1. The power cable, extension cable, or plug is damaged.
2. An object has fallen into the product.
3. The product has been exposed to water.
4. The product has been dropped or damaged.
5. The product does not operate correctly when you follow the operating instructions.



*These units contain no user-serviceable parts.*



*Additional safety guidelines, such as Waste Electrical and Electronic Equipment (WEEE), are given in the document [NetVanta Safety and Regulatory Information](https://supportforums.adtran.com) available at <https://supportforums.adtran.com>.*

**Save These Important Safety Instructions**

## FCC-Required Information

### FCC regulations require that the following information be provided in this manual:

1. This equipment complies with Part 68 of Federal Communications Commission (FCC) rules and requirements adopted by America's Carriers Telecommunications Association (ACTA). Each registered interface has a label that contains, among other information, a product identifier in the format US:AAAEQ##TXXXX. If requested, provide this information to the telephone company.
2. If this equipment causes harm to the telephone network, the telephone company may temporarily discontinue service. If possible, advance notification is given; otherwise, notification is given as soon as possible. The telephone company will advise the customer of the right to file a complaint with the FCC.
3. The telephone company may make changes in its facilities, equipment, operations, or procedures that could affect the proper operation of this equipment. Advance notification and the opportunity to maintain uninterrupted service are given.
4. If experiencing difficulty with this equipment, please contact ADTRAN for repair and warranty information. The telephone company may require this equipment to be disconnected from the network until the problem is corrected, or it is certain the equipment is not malfunctioning.
5. This unit contains no user-serviceable parts.
6. This equipment is designed to connect to the telephone network or premises wiring using an FCC-compatible modular jack, which is compliant with Part 68 and requirements adopted by ACTA.
7. The following information may be required when applying to the local telephone company for leased line facilities:

Part Number	Registration Number	Service Type	REN/SOC	FIC	USOC
1700600L2	US: HDCMM01A1700600L2	Analog Loop Start	0.1A/9.0Y	02LS2	RJ-11C
1700610L2	US: HDCDL01A1700610L2	ADSL, ADSL2, ADSL2+ Modem	0.1A	Metallic	RJ-11C

8. The ringer equivalency number (REN) is useful in determining the quantity of devices you may connect to your telephone line and still have all of those devices ring when your number is called. In most areas, the sum of the RENs of all devices should not exceed five. To be certain of the number of devices you may connect to your line as determined by the REN, call your telephone company to determine the maximum REN for your calling area.
9. This equipment may not be used on coin service provided by the telephone company. Connection to party lines is subject to state tariffs. Contact your state public utility commission or corporation commission for information.

## FCC Radio Frequency Interference Statement

This equipment has been tested and found to comply with the limits for a Class A digital device, pursuant to Part 15 of the FCC rules. These limits are designed to provide reasonable protection against harmful interference when the equipment is operated in a commercial environment. This equipment generates, uses, and can radiate radio frequency energy and, if not installed and used in accordance with the instruction manual, may cause harmful interference to radio frequencies. Operation of this equipment in a residential area is likely to cause harmful interference in which case the user will be required to correct the interference at his own expense.

## Industry Canada Compliance Information

Notice: The Industry Canada label applied to the product (identified by the Industry Canada logo or the “IC:” in front of the certification/registration number) signifies that the Industry Canada technical specifications were met.

Notice: The REN for this terminal equipment is supplied in the documentation or on the product labeling/markings. The REN assigned to each terminal device indicates the maximum number of terminals that can be connected to a telephone interface. The termination on an interface may consist of any combination of devices subject only to the requirement that the sum of the RENs of all the devices should not exceed five (5).

## Canadian Emissions Requirements

This digital apparatus does not exceed the Class A limits for radio noise emissions from digital apparatus as set out in the interference-causing equipment standard entitled “Digital Apparatus,” ICES-003 of the Department of Communications.

Cet appareil numérique respecte les limites de bruits radioélectriques applicables aux appareils numériques de Class A prescrites dans la norme sur le matériel brouilleur: “Appareils Numériques,” NMB-003 édictée par le ministre des Communications.

## Toll Fraud Liability

Be advised that certain security risks are inherent in the use of any telecommunications or networking equipment, including but not limited to, toll fraud, Denial of Service (DoS) attacks, loss or theft of data, and the unauthorized or illegal use of said equipment. ADTRAN OFFERS NO WARRANTIES, EITHER EXPRESSED OR IMPLIED, REGARDING THE PREVENTION, DETECTION, OR DETERRENCE OF TOLL FRAUD, NETWORKING ATTACKS, OR UNAUTHORIZED, ILLEGAL, OR IMPROPER USE OF ADTRAN EQUIPMENT OR SOFTWARE. THEREFORE, ADTRAN IS NOT LIABLE FOR ANY LOSSES OR DAMAGES RESULTING FROM SUCH FRAUD, ATTACK, OR IMPROPER USE, INCLUDING, BUT NOT LIMITED TO, HUMAN AND DATA PRIVACY, INTELLECTUAL PROPERTY, MATERIAL ASSETS, FINANCIAL RESOURCES, LABOR AND LEGAL COSTS. Ultimately, the responsibility for securing your telecommunication and networking equipment rests with you, and you are encouraged to review documentation regarding available security measures, their configuration and implementation, and to test such features as is necessary for your network.

## Service and Warranty

For information on the service and warranty of ADTRAN products, visit the [Support](#) section of the ADTRAN website at <http://www.adtran.com>.

# Table of Contents

<b>Introduction</b> .....	<b>13</b>
<b>Physical Descriptions</b> .....	<b>14</b>
NetVanta 3120 .....	14
NetVanta 3120 Features and Specifications .....	14
NetVanta 3120 Shipping Contents .....	15
NetVanta 3120 Front Panel Design .....	15
NetVanta 3120 Rear Panel Design .....	16
NetVanta 3130 .....	17
NetVanta 3130 Features and Specifications .....	17
NetVanta 3130 Shipping Contents .....	18
NetVanta 3130 Front Panel Design .....	18
NetVanta 3130 Rear Panel Design .....	19
NetVanta 3100 Series Front Panel LEDs .....	21
<b>Unit Installation</b> .....	<b>22</b>
Tools Required .....	22
Mounting Options .....	22
Tabletop Mounting the NetVanta 3100 Series .....	22
Wall Mounting NetVanta 3100 Series .....	22
Supplying Power to the Unit .....	24
<b>Appendix A. Connector Pin Definitions</b> .....	<b>25</b>





## List of Figures

Figure 1.	NetVanta 3120 (with DBU) Front Panel Layout . . . . .	15
Figure 2.	NetVanta 3120 (without DBU) Front Panel Layout . . . . .	15
Figure 3.	NetVanta 3120 (with DBU) Rear Panel Layout . . . . .	16
Figure 4.	NetVanta 3120 (without DBU) Rear Panel Layout . . . . .	16
Figure 5.	NetVanta 3130 (with DBU) Front Panel Layout . . . . .	18
Figure 6.	NetVanta 3130 (without DBU) Front Panel Layout . . . . .	19
Figure 7.	NetVanta 3130 (with DBU) Rear Panel Layout . . . . .	19
Figure 8.	NetVanta 3130 (without DBU) Rear Panel Layout . . . . .	19
Figure 9.	Wall Mounting the NetVanta 3100 Series . . . . .	23
Figure 10.	NetVanta 3100 Series Power Connector . . . . .	24



## List of Tables

Table 1.	NetVanta 3100 Series Front Panel LEDs .....	21
Table A-1.	10/100Base-T Ethernet Port Pinouts .....	25
Table A-2.	DBU Connector Pinouts .....	25
Table A-3.	ADSL Connector Pinouts .....	25



## 1. INTRODUCTION

The NetVanta 3100 Series Fixed Port Routers includes the NetVanta 3120 (with dial backup (DBU)), NetVanta 3120 (without DBU), NetVanta 3130 (with DBU) and NetVanta 3130 (without DBU).



*In this document, the term NetVanta 3100 means all of the units collectively. If a statement only applies to one particular router, the text refers to the router individually.*

This hardware installation guide lists the NetVanta 3100 Series units' physical characteristics and product specifications, introduces basic functionality, and provides installation instructions.

- *[Physical Descriptions on page 14](#)*
- *[Unit Installation on page 22](#)*

For additional information on mounting options and supplying power to the unit, refer to the following sections:

- *[Mounting Options on page 22](#)*
- *[Supplying Power to the Unit on page 24](#)*

For information on switch configuration for a specific application, refer to the configuration guides provided on the [ADTRAN Support Community](#). For details on the command line interface (CLI), refer to the *[AOS Command Reference Guide](#)*. All other related documents are also available online at <http://supportforums.adtran.com>.

## 2. PHYSICAL DESCRIPTIONS

### NetVanta 3120

The NetVanta 3120 is a fixed-port Ethernet router with an integral four-port Ethernet switch. It provides a single auto-sensing 10/100Base-T Ethernet network interface and four auto-sensing 10/100Base-T Ethernet LAN interfaces. This product is ideal for enterprise-level Internet access for secure, high-speed corporate connectivity using broadband access such as DSL or cable. Some models include an integrated analog modem for dial backup and management. IPsec virtual private network (VPN) support is included without further software upgrade. The unit is powered by a 12 VDC power supply (AC to DC power adapter included).

### ***NetVanta 3120 Features and Specifications***

The NetVanta 3120 offers the following features:

- Fixed-port Ethernet router with integral 4-port Ethernet switch
- Autosensing 10/100Base-T Ethernet WAN
- Integrated analog modem for dial backup or remote management (1700600L2 only)
- ADTRAN Operating System (AOS) command line interface (CLI)
- User-friendly, web-based graphical user interface (GUI)
- Standards-based eBGP/iBGP, OSPF, RIP, static routing and bridging protocols
- Integral stateful inspection firewall protects against denial of service (DoS) attacks
- Includes IPsec VPN supporting DES/3DES/AES encryption
- Compatible with ISsec VPN-equipped devices
- Quality of service (QoS) with low latency queuing (LLQ), weighted fair queuing (WFQ), class-based weighted fair queuing (CBWFQ), and DiffServ marking
- Built-in alert and logging mechanisms
- Network address translation (NAT/NAPT), 1:1 NAT port translation, and NAT Traversal version 2
- NAT-compliant SIP ALG
- DHCP client, server, and relay
- XAUTH including RADIUS and RSA SecurID
- AAA support using local user database, RADIUS, and TACACS+
- Flash memory supports dual images of AOS
- Remotely configurable and field upgradeable using TFTP or FTP (1700601G2 only)
- Telnet, HTTP, SSH, or SNMP management options
- 1.63-inch H x 9.00-inch W x 6.38-inch D
- DC power (12 VDC, 800 mA, 7.5 W)
- Operating Temperature: 0°C to 50°C
- RoHS compliant (Telecommunications exemption) (1700601G1 only)

### NetVanta 3120 Shipping Contents

Each NetVanta 3120 unit is shipped in its own cardboard shipping carton. Open each carton carefully, and avoid deep penetration into the carton with sharp objects.

After unpacking the unit, inspect it for possible shipping damage. If the equipment has been damaged in transit, immediately file a claim with the carrier and contact ADTRAN Customer Service (refer to the *Support* page on the ADTRAN website at <http://www.adtran.com/support>).

Shipments of the NetVanta 3120 include the following items:

- NetVanta 3120 base unit
- Quick start guide
- External 12 VDC power supply
- Two 7-foot CAT 5e cables

### NetVanta 3120 Front Panel Design

The NetVanta 3120 front panel is shown below. Front panel LED descriptions are given in *Table 1 on page 21*.



Figure 1. NetVanta 3120 (with DBU) Front Panel Layout



Figure 2. NetVanta 3120 (without DBU) Front Panel Layout

### NetVanta 3120 Rear Panel Design

The NetVanta 3120 rear panel is shown below. [Appendix A on page 25](#) provides pinouts.

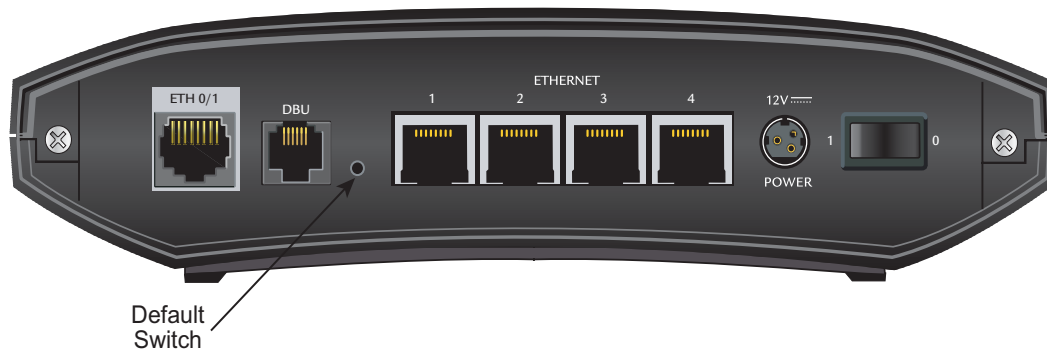

**Figure 3. NetVanta 3120 (with DBU) Rear Panel Layout**

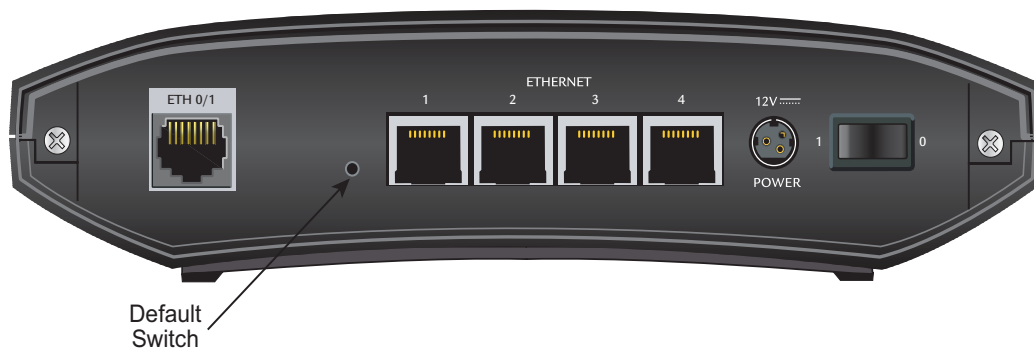

**Figure 4. NetVanta 3120 (without DBU) Rear Panel Layout**

### NetVanta 3120 Rear Panel Interfaces

#### 10/100Base-T Ethernet Interface

The Ethernet port (**ETH 0/1**) is an RJ-45 connector. See [Table A-1 on page 25](#) for the Ethernet port pinouts. The Ethernet port provides the following:

- 10Base-T or 100Base-T with a single connector
- Auto-negotiation
- CSMA/CD
- IEEE 802.3 compatibility

#### DBU Interface (1700600L2 only)

The NetVanta 3120 has a **DBU** port on the rear panel to provide analog, V.90 dial backup. See [Table A-2 on page 25](#) for the DBU connector pinouts.

#### Factory Default Switch

The NetVanta 3120 has a factory default switch (labeled in [Figure 3](#)) on the rear of the unit. If the factory default switch is pressed during bootup, the unit will stay in bootstrap mode. Since the unit has no serial port, Telnet has been built into the boot code. The default IP address is 10.10.10.1.





*The default switch must be pressed WHILE the STAT light is flashing green. Do not press the default switch BEFORE the STAT light is flashing green, as this will cause boot to be missed.*

If the factory default switch is pressed and held for 5 seconds after boot, the switch ports on the NetVanta 3120 will default to 10.10.10.1 and all access policies will be removed from those interfaces. If the factory default switch is pressed for 30 seconds, a default configuration will overwrite your existing configuration and reboot the unit.

#### 4 Switch Port Interfaces

Ports 1 through 4 are RJ-45 connectors used to access the 10/100Base-T Ethernet switch.

#### Power Connection

The rear panel has a **12V** input for the DC power supply included in the shipment. Please refer to [Supplying Power to the Unit on page 24](#) for connection details.

## NetVanta 3130

The NetVanta 3130 is a fixed-port ADSL2+ IP access router with an integral four-port Ethernet switch. It provides a single ADSL network interface and four auto-sensing 10/100Base-T Ethernet LAN interfaces. This product is ideal for carrier-bundled service offerings and enterprise-level Internet access for secure, high-speed corporate connectivity. In addition to supporting ADSL (Annex A), and ADSL2, the NetVanta 3130 supports today's most advanced ADSL technology, ADSL2+, for greater reach and higher bandwidth, up to 25 Mbps. Some models include an integrated analog modem for dial backup and management. IPsec VPN support is included without further software upgrade. The unit is powered by a 12 VDC power supply (AC to DC power adapter included).

### NetVanta 3130 Features and Specifications

The NetVanta 3130 offers the following features:

- Fixed-port ADSL router with integral 4-port Ethernet switch
- IP access router for ADSL, ADSL2, ADSL2+ networks with line rates up to 25 Mbps
- Supports ATM, PPP over ATM, and PPPoE over ATM
- Integrated analog modem for dial backup or remote management (1700610L2 only)
- ADTRAN Operating System (AOS) command line interface (CLI)
- User-friendly, web-based graphical user interface (GUI)
- Standards-based eBGP/iBGP, OSPF, RIP, static routing and bridging protocols
- Integral stateful inspection firewall protects against denial of service (DoS) attacks
- Includes ISsec VPN supporting DES/3DES/AES encryption
- Compatible with ISsec VPN-equipped devices
- Quality of service (QoS) with low latency queuing (LLQ), weighted fair queuing (WFQ), class-based weighted fair queuing (CBWFQ), and DiffServ marking
- Built-in alert and logging mechanisms
- Network address translation (NAT/NAPT), 1:1 NAT port translation, and NAT Traversal version 2
- NAT-compliant SIP ALG
- DHCP client, server, and relay
- XAUTH including RADIUS and RSA SecurID

- AAA support using local user database, RADIUS, and TACACS+
- Flash memory supports multiple images of AOS
- Remotely configurable and field upgradeable using TFTP or FTP (1700611G2 only)
- Telnet, HTTP, SSH, or SNMP management options
- 1.63-inch H x 9.00-inch W x 6.38-inch D
- DC power (12 VDC, 800 mA, 7.5 W)
- Operating Temperature: 0°C to 50°C
- RoHS compliant (Telecommunications exemption) (1700611G2, 1700612G1 only)

### **NetVanta 3130 Shipping Contents**

Each NetVanta 3130 unit is shipped in its own cardboard shipping carton. Open each carton carefully, and avoid deep penetration into the carton with sharp objects.

After unpacking the unit, inspect it for possible shipping damage. If the equipment has been damaged in transit, immediately file a claim with the carrier and contact ADTRAN Customer Service (refer to the *Support* page on the ADTRAN website at <http://www.adtran.com/support>).

Shipments of the NetVanta 3130 include the following items:

- NetVanta 3130 base unit
- Quick start guide
- External 12 VDC power supply
- One 7-foot CAT 5e cable
- One 7-foot phone cable

### **NetVanta 3130 Front Panel Design**

The NetVanta 3130 front panel is shown below. Front panel LED descriptions are given in *Table 1 on page 21*.

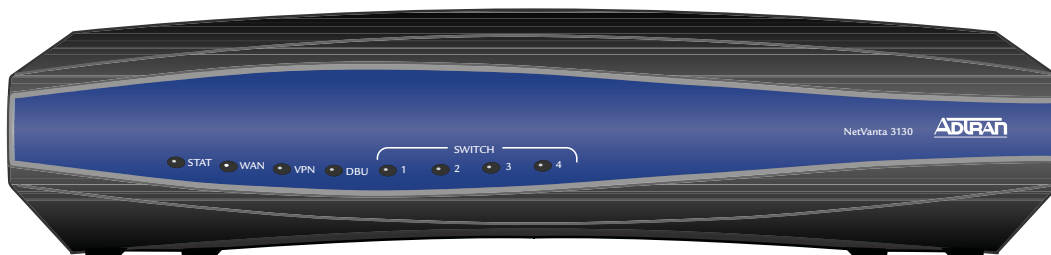

**Figure 5. NetVanta 3130 (with DBU) Front Panel Layout**



Figure 6. NetVanta 3130 (without DBU) Front Panel Layout

### NetVanta 3130 Rear Panel Design

The NetVanta 3130 rear panel is shown below. [Appendix A on page 25](#) provides pinouts.

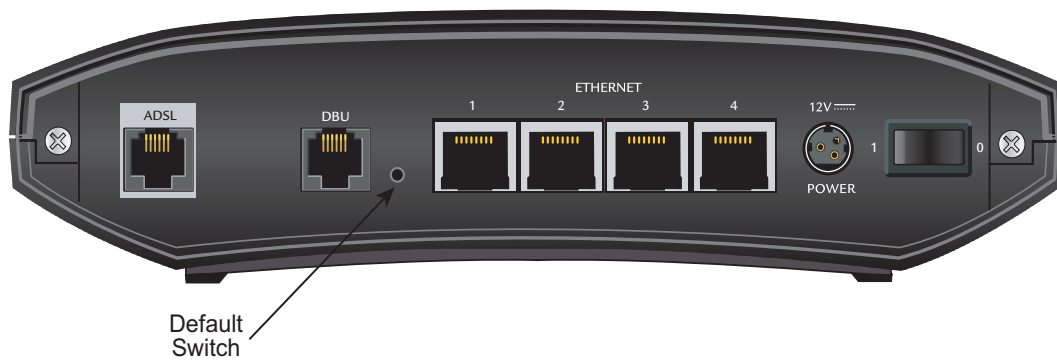

Figure 7. NetVanta 3130 (with DBU) Rear Panel Layout

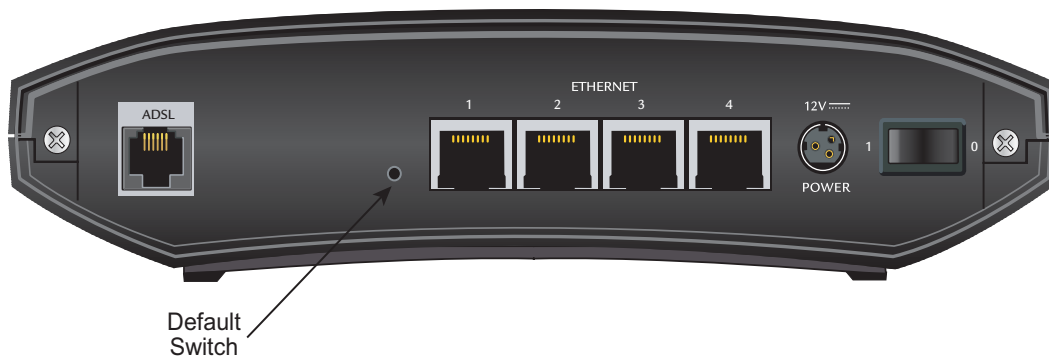

Figure 8. NetVanta 3130 (without DBU) Rear Panel Layout

### NetVanta 3130 Rear Panel Interfaces

#### ADSL Interface

The NetVanta 3130 rear panel has an **ADSL** port to connect directly to ADSL, ADSL2, or ADSL2+ service. See [Table A-3 on page 25](#) for the ADSL connector pinouts.

**DBU Interface (1700610L2 only)**

The NetVanta 3130 has a **DBU** port on the rear panel to provide analog, V.90 dial backup. See [Table A-2 on page 25](#) for the DBU connector pinouts.

**Factory Default Switch**

The NetVanta 3130 has a factory default switch (labeled in [Figure 7](#)) on the rear of the unit. If the factory default switch is pressed during bootup, the unit will stay in bootstrap mode. Since the unit has no serial port, Telnet has been built into the boot code. The default IP address is 10.10.10.1.



*The default switch must be pressed WHILE the **STAT** light is flashing green. Do not press the default switch BEFORE the **STAT** light is flashing green, as this will cause boot to be missed.*

If the factory default switch is pressed and held for 5 seconds after boot, the switch ports on the NetVanta 3130 will default to 10.10.10.1 and all access policies will be removed from those interfaces.

If the factory default switch is pressed for 30 seconds, a default configuration will overwrite your existing configuration and reboot the unit.

**4 Switch Port Interfaces**

Ports 1 through 4 are RJ-45 connectors used to access the 10/100Base-T Ethernet switch.

**Power Connection**

The rear panel has a **12V** input for the DC power supply included in the shipment. Please refer to [Supplying Power to the Unit on page 24](#) for connection details.

## NetVanta 3100 Series Front Panel LEDs

*Table 1* describes the front panel LEDs.

**Table 1. NetVanta 3100 Series Front Panel LEDs**

LED	Color	Indication
<b>STAT</b>	Green (flashing)	The unit is powering up. On power up the <b>STAT</b> LED flashes rapidly for five seconds, during which time the user can escape to boot mode. The factory default switch on the back of the unit must be pressed while the <b>STAT</b> LED is flashing green to escape to boot mode. Refer to <a href="#">Factory Default Switch on page 20</a> for more information.
	Green (solid)	The power is on and self-test passed.
	Red (solid)	The power is on, but the self-test failed or the boot mode (if applicable) code could not be booted.
<b>WAN</b> (NetVanta 3130 only)	Off	The interface is administratively down.
	Green (solid)	The link is up and everything is operational.
	Green (flashing)	The port has activity.
	Red (solid)	An alarm condition is occurring on the WAN interface, or there is a self-test failure.
	Amber (solid)	The unit is in test.
<b>DBU</b> (NetVanta 3120/ 3130 with DBU)	Off	The DBU interface is administratively down.
	Green (solid)	The DBU interface is enabled.
	Green (flashing)	The unit is in dial backup.
	Red (solid)	An alarm condition is occurring on the DBU interface, or there is a self-test failure.
	Amber (solid)	The unit is in test.
<b>ETH1</b> (NetVanta 3120 only)	Off	The port is administratively disabled or does not have link.
	Green (solid)	The port is enabled and the link is up.
	Amber (flashing)	The port has activity (transmit or receive).
<b>INET</b> (NetVanta 3120/ 3130 without DBU)	Off	PPP or PPPoE is not connected, IP has no IP address via DHCP, or IP is static.
	Green (solid)	PPP or PPPoE is connected or IP has an address via DHCP.
	Green (flashing)	WAN interface is attempting to obtain an IP address via DHCP.
<b>SWITCH</b> (1 through 4)	Off	The port is administratively disabled or does not have link.
	Green (solid)	The port is enabled and the link is up.
	Amber (flashing)	The port has activity (transmit or receive).
<b>VPN</b>	Off	No encrypted traffic.
	On	Encrypted traffic present.

### 3. UNIT INSTALLATION

The instructions and guidelines provided in this section cover hardware installation topics, such as wall mounting/rack mounting the unit and installing option cards. These instructions are presented as follows:

- [Mounting Options on page 22](#)
- [Supplying Power to the Unit on page 24](#)

For information on router configuration for a specific application, refer to the configuration guides provided on the [ADTRAN Support Community](#). For details on the command line interface (CLI), refer to the [AOS Command Reference Guide](#). All other related documents are also available online at <http://supportforums.adtran.com>.

**WARNING**

*To prevent electrical shock, do not install equipment in a wet location or during a lightning storm.*

**WARNING**

*Ethernet cables are intended for intrabuilding use only. Connecting an ADTRAN unit directly to Ethernet cables that run outside the building in which the unit is housed will void the user's warranty and could create a fire or shock hazard. To connect an ADTRAN unit to Ethernet cables that run outside the building, ADTRAN's Ethernet Port Protection Device (EPPD) (P/N 1700502G1) must be connected between the unit and the outside plant cable. Use of any Ethernet protector other than ADTRAN's for this purpose will void the user's warranty.*

#### Tools Required

The customer-provided tools required for the hardware installation of the NetVanta 3100 Series are:

- Ethernet cable
- Phillips-head screwdriver

#### Mounting Options

The NetVanta 3100 Series can be installed in a wallmount or tabletop configuration.

##### ***Tabletop Mounting the NetVanta 3100 Series***

For tabletop mounting, place the unit on a level surface within easy reach of an electrical outlet.

##### ***Wall Mounting NetVanta 3100 Series***

The NetVanta 3100 Series units can be wall mounted. By following these instructions exactly, the NetVanta can be safely mounted to the wall.

 <p><b>CAUTION</b></p>	<ul style="list-style-type: none"> <li>To avoid damaging the unit, use only the screws included in the shipment when attaching mounting ears to the chassis.</li> <li>When wall mounting the NetVanta, care must be taken not to damage the power cord. Do not attach the power cord to the building surface or run it through walls, ceilings, floors, or openings in the building structure.</li> <li>The socket-outlet must be installed near the equipment and must be easily accessible.</li> </ul>
---	--

Instructions for Wall Mounting NetVanta 3100 Series	
Step	Action
1	Decide on a location for the unit. Keep in mind that the unit needs to be mounted at or below eye level so that the LEDs are viewable.
2	Prepare the mounting surface by attaching a board (typically plywood, 3/4-inch to 1-inch thick) to a wall stud. <b>Important! Mounting to a stud ensures stability. Using sheetrock anchors may not provide sufficient long-term stability.</b>
3	Install two #8 PAN head screws (1-inch or greater in length) into the mounted board, following these guidelines and referring to <a href="#">Figure 9</a> . <ul style="list-style-type: none"> <li>Screws should be spaced horizontally, approximately 5 inches apart. Find exact positioning by using the location of the two keyed insets on the bottom of the unit as a guide.</li> <li>Screws should be horizontally level with each other.</li> <li>Leave approximately 1/4-inch of the screws protruding from the board to allow the heads of the screws to slide into place in the unit's keyed insets.</li> </ul>
4	Slide the keyed insets on the bottom of the unit's chassis securely onto the screws.
5	Proceed to the steps given in <a href="#">Supplying Power to the Unit on page 24</a> .

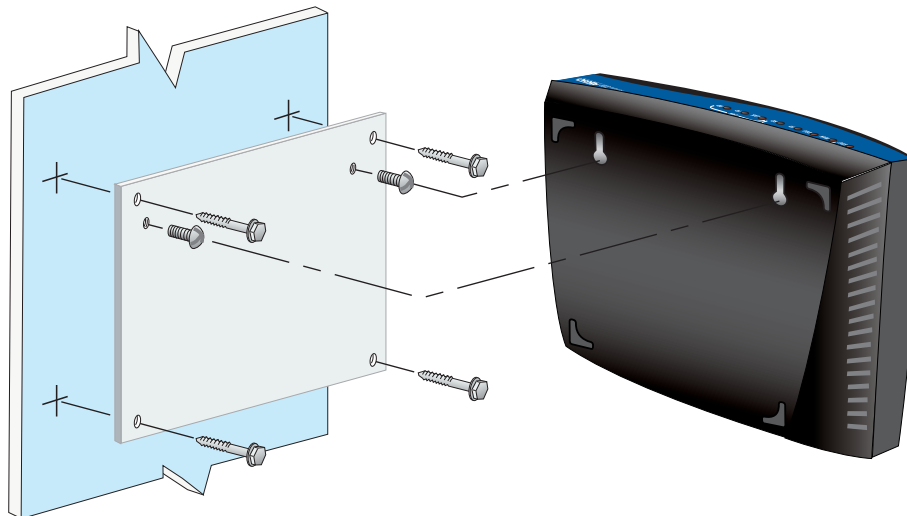

**Figure 9. Wall Mounting the NetVanta 3100 Series**

## Supplying Power to the Unit

The NetVanta 3100 Series comes equipped with a 12 VDC power supply for connecting to the proper power receptacles.

Instructions for Powering the NetVanta 3100 Series	
Step	Action
1	To insert the 12 VDC power connector, pull the outer sheath back from the metal connector, as shown in <a href="#">Figure 10</a> .
2	Insert the connector into the receptacle (labeled <b>POWER</b> ) on the back of the unit keeping the sheath retracted until the connector is fully inserted into the receptacle.
3	Release the sheath so that it covers the metal connector. This ensures that the connector will not become disengaged during use.



**Figure 10. NetVanta 3100 Series Power Connector**

Your NetVanta unit is now ready to be configured and connected to the network. For information on configuration for a specific application, refer to the configuration guides provided on the [ADTRAN Support Community](#). For details on the command line interface (CLI), refer to the [AOS Command Reference Guide](#). All other related documents are also available online at <http://supportforums.adtran.com>.



## APPENDIX A. CONNECTOR PIN DEFINITIONS

The following tables provide the pin assignments for the NetVanta 3100 Series base units.

### Base Unit Pinouts

**Table A-1. 10/100Base-T Ethernet Port Pinouts**

Pin	Name	Description
1	TX1	Transmit Positive (PoE negative rail, switch ports only)
2	TX2	Transmit Negative (PoE negative rail, switch ports only)
3	RX1	Receive Positive (PoE negative rail, switch ports only)
4, 5	—	Unused
6	RX2	Receive Negative (PoE negative rail, switch ports only)
7, 8	—	Unused

**Table A-2. DBU Connector Pinouts**

Pin	Name	Description
1-2	—	Unused
3	R	Network–Ring
4	T	Network–Tip
5-6	—	Unused

**Table A-3. ADSL Connector Pinouts**

Pin	Name	Description
1-2	—	Unused
3	R	Network–Ring
4	T	Network–Tip
5-6	—	Unused

